

# IGBT Modules

## Sixpack, H Bridge

Short Circuit SOA Capability  
 Square RBSOA

$I_{C25} = 165 \text{ A}$   
 $V_{CES} = 1200 \text{ V}$   
 $V_{CE(sat) \text{ typ.}} = 2.0 \text{ V}$

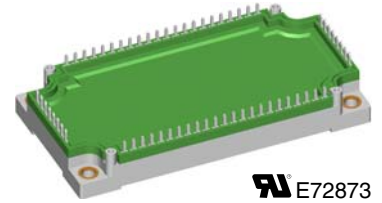
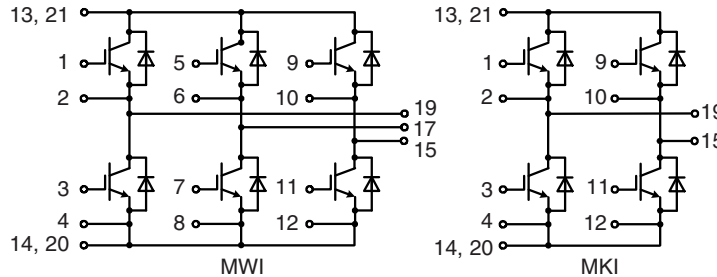

See outline drawing for pin arrangement

IGBTs		
Symbol	Conditions	Maximum Ratings
$V_{CES}$	$T_{VJ} = 25^{\circ}\text{C to } 150^{\circ}\text{C}$	1200 V
$V_{GES}$		$\pm 20 \text{ V}$
$I_{C25}$	$T_C = 25^{\circ}\text{C}$	165 A
$I_{C80}$	$T_C = 80^{\circ}\text{C}$	115 A
$I_{CM}$	$V_{GE} = \pm 15 \text{ V}; R_G = 12 \Omega; T_{VJ} = 125^{\circ}\text{C}$	200 A
$V_{CEK}$	RBSOA; clamped inductive load; $L = 100 \mu\text{H}$	$V_{CES}$
$t_{SC}$	$V_{CE} = 900 \text{ V}; V_{GE} = \pm 15 \text{ V}; R_G = 12 \Omega; T_{VJ} = 125^{\circ}\text{C}$ SCSOA; non-repetitive	10 $\mu\text{s}$
$P_{tot}$	$T_C = 25^{\circ}\text{C}$	640 W

### Features

- NPT<sup>3</sup> IGBTs
  - low saturation voltage
  - positive temperature coefficient for easy paralleling
  - fast switching
  - short tail current for optimized performance also in resonant circuits
- HiPerFRED™ diode:
  - fast reverse recovery
  - low operating forward voltage
  - low leakage current
- Industry Standard Package
  - solderable pins for PCB mounting
  - isolated copper base plate

Symbol	Conditions	Characteristic Values ( $T_{VJ} = 25^{\circ}\text{C}$ , unless otherwise specified)		
		min.	typ.	max.
$V_{CE(sat)}$	$I_C = 100 \text{ A}; V_{GE} = 15 \text{ V}; T_{VJ} = 25^{\circ}\text{C}$ $T_{VJ} = 125^{\circ}\text{C}$		2.0 2.3	V V
$V_{GE(th)}$	$I_C = 4 \text{ mA}; V_{GE} = V_{CE}$	4.5		6.5 V
$I_{CES}$	$V_{CE} = V_{CES}; V_{GE} = 0 \text{ V}; T_{VJ} = 25^{\circ}\text{C}$ $T_{VJ} = 125^{\circ}\text{C}$		1.4	1.4 mA mA
$I_{GES}$	$V_{CE} = 0 \text{ V}; V_{GE} = \pm 20 \text{ V}$			400 nA
$t_{d(on)}$ $t_r$ $t_{d(off)}$ $t_f$	Inductive load, $T_{VJ} = 125^{\circ}\text{C}$ $V_{CE} = 600 \text{ V}; I_C = 100 \text{ A}$ $V_{GE} = \pm 15 \text{ V}; R_G = 12 \Omega$		330	ns
$E_{on}$			15	ns
$E_{off}$			750	ns
			45	ns
			12	mJ
$C_{ies}$	$V_{CE} = 25 \text{ V}; V_{GE} = 0 \text{ V}; f = 1 \text{ MHz}$		7.4	nF
$Q_{Gon}$	$V_{CE} = 600 \text{ V}; V_{GE} = 15 \text{ V}; I_C = 150 \text{ A}$		0.76	$\mu\text{C}$
$R_{thJC}$	(per IGBT)			0.19 K/W

### Typical Applications

- MWI
  - AC drives
  - power supplies with power factor correction
- MKI
  - motor control
    - . DC motor amature winding
    - . DC motor excitation winding
    - . synchronous motor excitation winding
  - supply of transformer primary winding
    - . power supplies
    - . welding
    - . X-ray
    - . battery charger

## Diodes

Symbol	Conditions	Maximum Ratings	
$I_{F25}$	$T_C = 25^\circ\text{C}$	200	A
$I_{F80}$	$T_C = 80^\circ\text{C}$	130	A

Symbol	Conditions	Characteristic Values		
		min.	typ.	max.
$V_F$	$I_F = 100\text{ A}; V_{GE} = 0\text{ V}; T_{VJ} = 25^\circ\text{C}$ $T_{VJ} = 125^\circ\text{C}$	2.3	2.6	V
$I_{RM}$ $t_{rr}$	$I_F = 120\text{ A}; di_F/dt = -750\text{ A}/\mu\text{s}; T_{VJ} = 125^\circ\text{C}$ $V_R = 600\text{ V}; V_{GE} = 0\text{ V}$	58		A
		190		ns
$R_{thJC}$	(per diode)			0.3 K/W

## Module

Symbol	Conditions	Maximum Ratings	
$T_{VJ}$	operating	-40...+125	$^\circ\text{C}$
$T_{JM}$		+150	$^\circ\text{C}$
$T_{stg}$		-40...+125	$^\circ\text{C}$
$V_{ISOL}$	$I_{ISOL} \leq 1\text{ mA}; 50/60\text{ Hz}$	2500	V~
$M_d$	Mounting torque (M5)	3-6	Nm

Symbol	Conditions	Characteristic Values		
		min.	typ.	max.
$R_{pin-chip}$			1.8	m $\Omega$
$d_S$	Creepage distance on surface	10		mm
$d_A$	Strike distance in air	10		mm
$R_{thCH}$	with heatsink compound		0.01	K/W
Weight			300	g

## Equivalent Circuits for Simulation

### Conduction

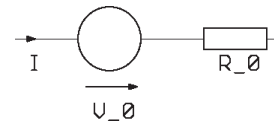

IGBT (typ. at  $V_{GE} = 15\text{ V}; T_J = 125^\circ\text{C}$ )  
 $V_0 = 0.95\text{ V}; R_0 = 14\text{ m}\Omega$

Free Wheeling Diode (typ. at  $T_J = 125^\circ\text{C}$ )  
 $V_0 = 1.27\text{ V}; R_0 = 4.3\text{ m}\Omega$

### Thermal Response

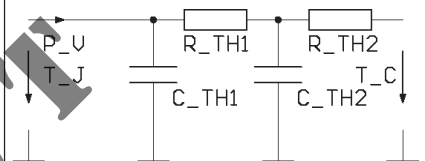

IGBT (typ.)

$C_{th1} = 0.389\text{ J/K}; R_{th1} = 0.139\text{ K/W}$   
 $C_{th2} = 2.154\text{ J/K}; R_{th2} = 0.051\text{ K/W}$

Free Wheeling Diode (typ.)

$C_{th1} = 0.301\text{ J/K}; R_{th1} = 0.24\text{ K/W}$   
 $C_{th2} = 2.005\text{ J/K}; R_{th2} = 0.062\text{ K/W}$

## Dimensions in mm (1 mm = 0.0394")

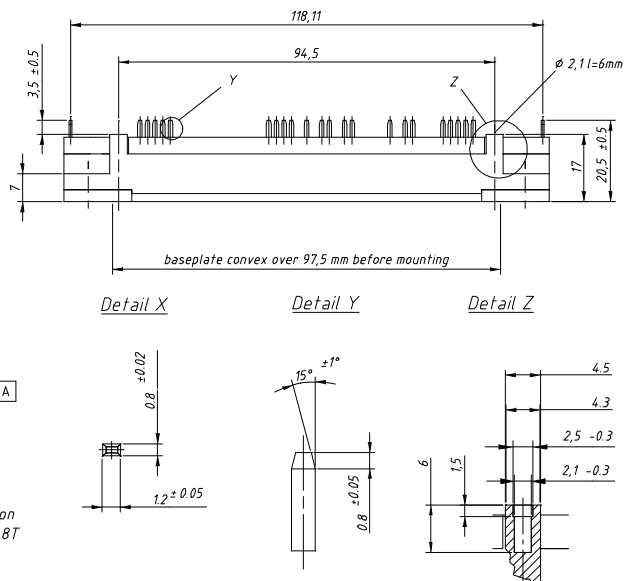
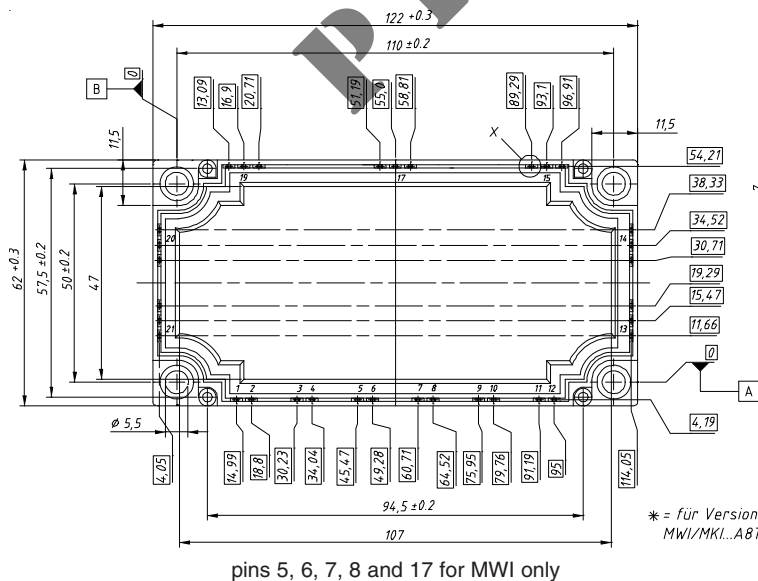

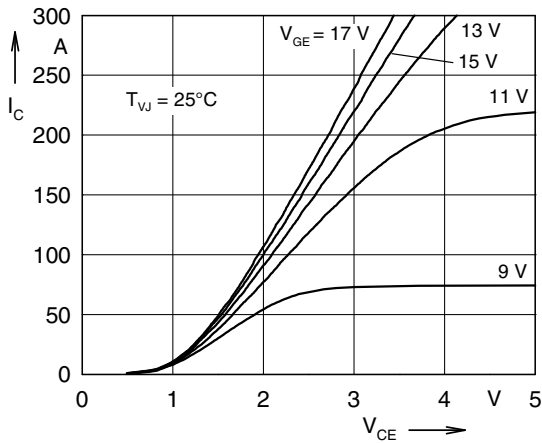

Fig. 1 Typ. output characteristics

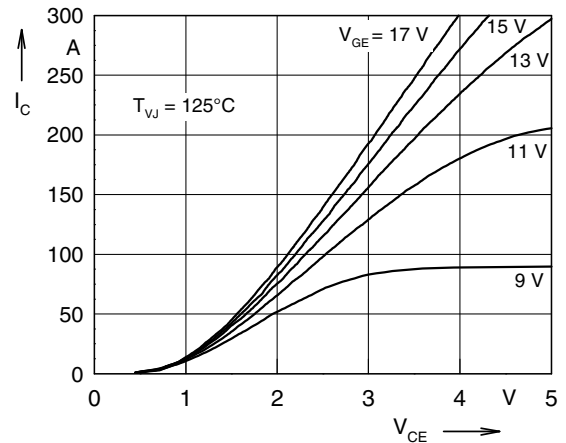

Fig. 2 Typ. output characteristics

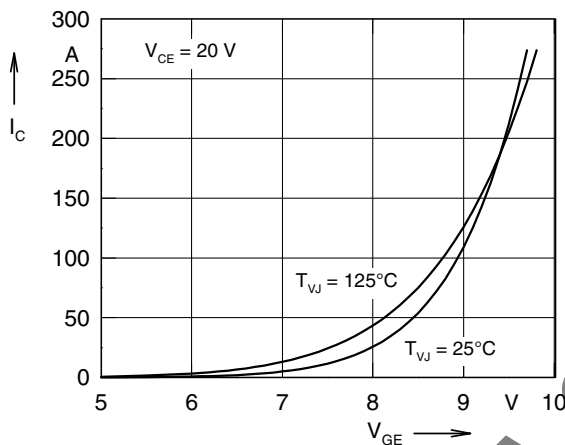

Fig. 3 Typ. transfer characteristics

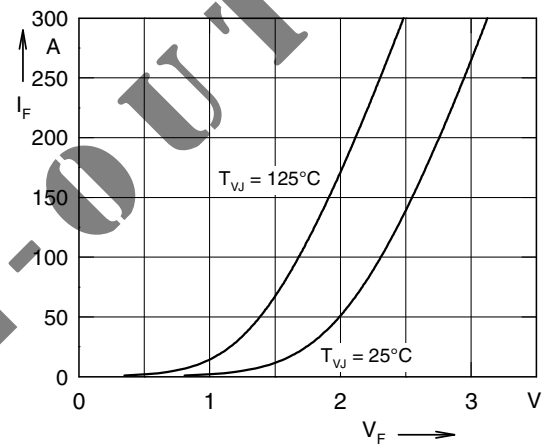

Fig. 4 Typ. forward characteristics of free wheeling diode

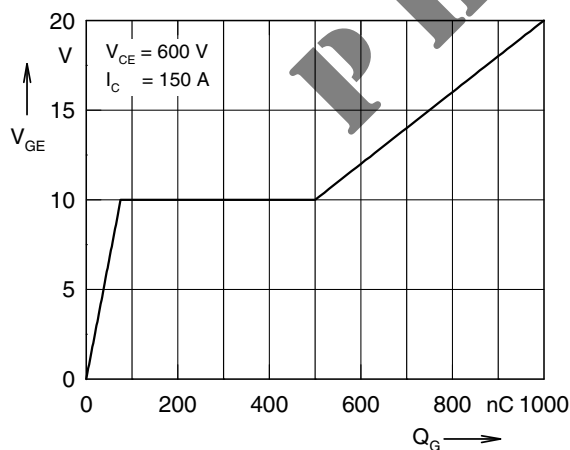

Fig. 5 Typ. turn on gate charge

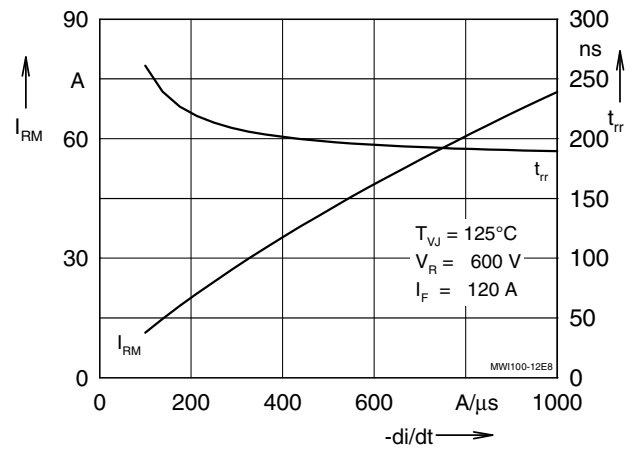

Fig. 6 Typ. turn off characteristics of free wheeling diode

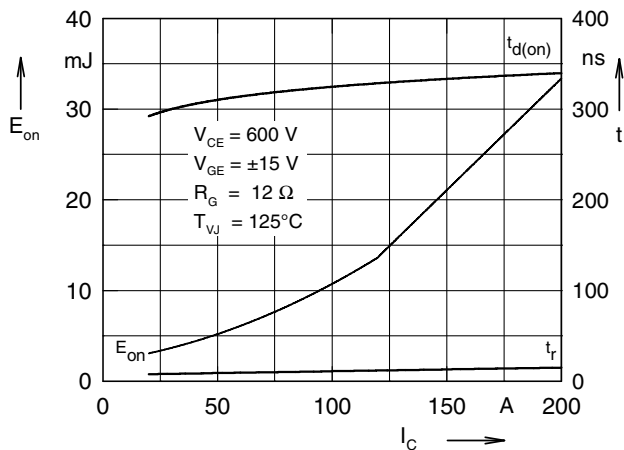

Fig. 7 Typ. turn on energy and switching times versus collector current

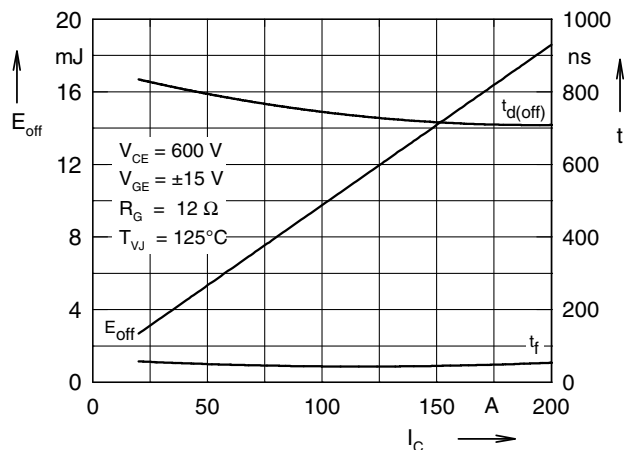

Fig. 8 Typ. turn off energy and switching times versus collector current

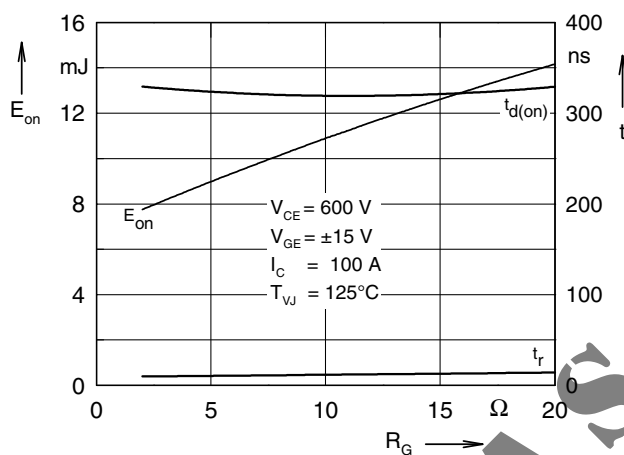

Fig. 9 Typ. turn on energy and switching times versus gate resistor

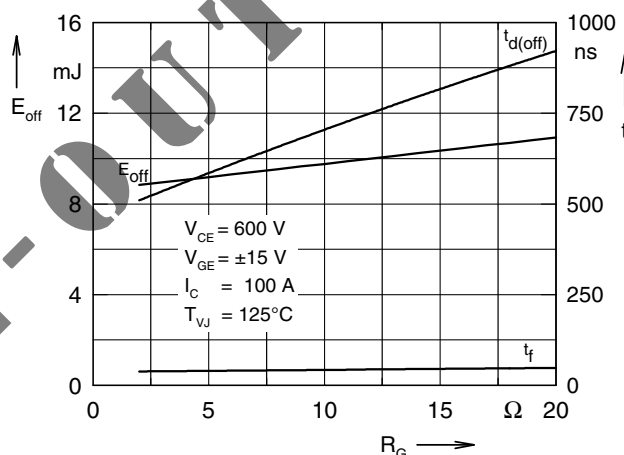

Fig.10 Typ. turn off energy and switching times versus gate resistor

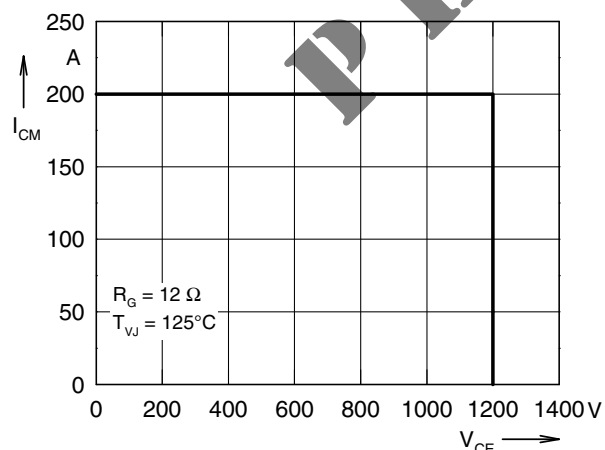

Fig. 11 Reverse biased safe operating area RBSOA

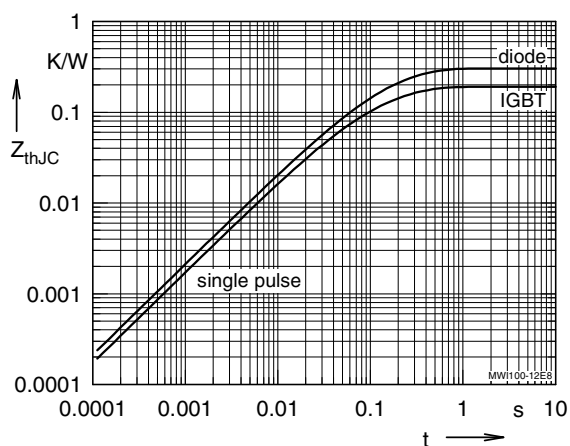

Fig. 12 Typ. transient thermal impedance