

THESE DRAWINGS ARE THE PROPERTY OF QUALTEK ELECTRONICS AND NOT TO BE REPRODUCED FOR OR COMMUNICATED TO A THIRD PARTY WITHOUT THE EXPRESS WRITTEN PERMISSION OF AN OFFICER OF QUALTEK ELECTRONICS.

REVISION			
REV.	DESCRIPTION	DATE	APPROVED
B	RoHS Compliancy	06-01-06	DP
C	Updated Approvals	03-16-15	LY

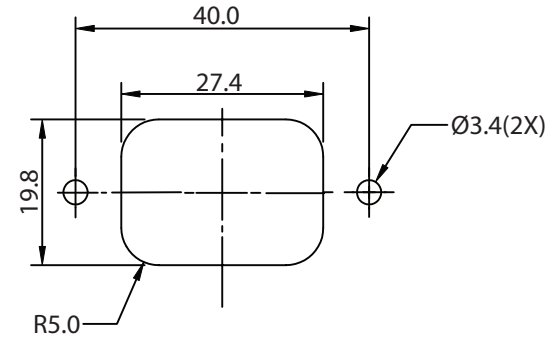

FRONT PANEL CUTOUT

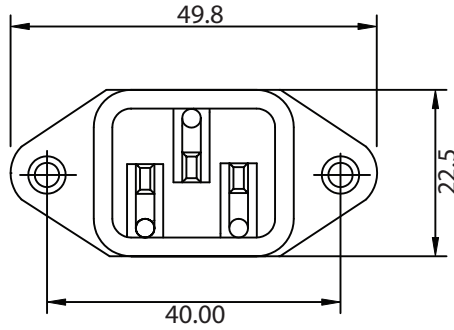
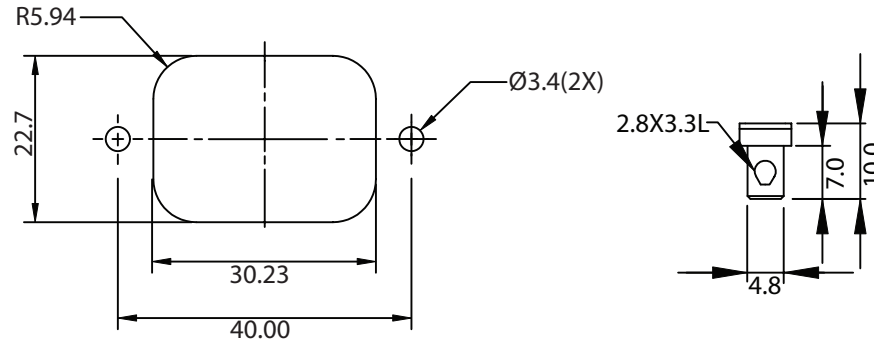
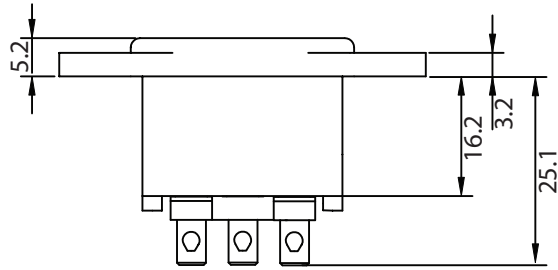

REAR PANEL CUTOUT

NOTES:

MATERIAL:

MOLDING: NYLON, FLAMMABILITY RATING UL 94V-0
 CONTACTS: BRASS. PINS NICKEL PLATED, TAGS TIN PLATED
 SCREW TERMINALS: NICKEL PLATED

RATING:

UL, CSA: 15A 250V AC
 CONTACT RESISTANCE: <10 m OHM
 INSULATION RESISTANCE: >10³ M OHM
 A.C. BREAKDOWN:
 POLE-POLE: 5kV
 POLES-PANEL: 5.4kV
 OPERATING TEMPERATURE: -40° C TO + 70° C
 MAX. PIN TEMPERATURE: +65° C
 APPROVALS: UL, CSA
 RoHS COMPLIANT

CONTROLLED

Dim range (mm)	Tolerance +/- (mm)	Qualtek Electronics Corp. PPC DIVISION		
		Part Number: 703-00/48	RoHS Compliant	
0-1	0.15	Description: AC RECEPTACLE		
1-6	0.20			
6-18	0.30		UNIT: mm	REV. C
18-50	0.50			
50-120	0.70	Drawn / Date	Checked / Date	Approved / Date
120-250	0.90	B. ZHANG 05-28-02	05-28-02	JJH / 05-28-02
250-500	1.20			