

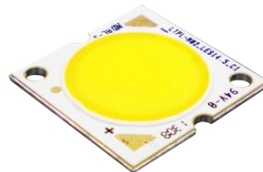

LED HIGH POWER CoB Product Series Data Sheet

Created Date: 02 / 06 / 2013
Revision: 4.0, 03 / 12 / 2014



LED HIGH POWER CoB Product Series

1. Description

The LiteON CoB Product series is a revolutionary, energy efficient and ultra compact new light source, combining the lifetime and reliability advantages of Light Emitting Diodes with the brightness of conventional lighting. It gives you total design freedom and unmatched brightness, creating a new opportunities for solid state lighting to displace conventional lighting technologies.

1.1 Features

- Compact high flux density light source
- Uniform high quality illumination
- Streamlined thermal path
- MacAdam compliant binning structure
More energy efficient than incandescent, halogen and fluorescent lamps
- Instant light with unlimited dimming
- RoHS compliant and Pb free

1.2 Benefits Features

- Enhanced optical control
- Clean white light without pixilation
- Uniform consistent white light
- Significantly reduced thermal resistance and increased operating temperatures
- Lower operating costs
- Reduced maintenance costs
- ESD rating is 8KV in HBM

1.3 Naming Rule

L T PL - M 0 2 5 X X Z S X X - X X
Code1 Code2 Code3 Code4 Code5 Code6 Code7

Code 1: Product Line

PL: High Power LED.

Code 2: Package Type/Platform

M02: Metal substrate with 20x20mm square.

Code 3: Light Emitting Surface

5: 14.5mm excluding dam

Code 4: Wattage

20: 20W package

30: 30W package

Code 5: Emission Color Characteristics

Z: White Color Rendering Index 80 Type.

Code6: Color Temperature

27: 2700K at 85degC

30: 3000K at 85degC

40: 4000K at 85degC

50: 5000K at 85degC

57: 5700K at 85degC

Note: The Color Temperature follow ANSI C78.377A Doc.

Code7: Hue Bin by MacAdam Ellipses Step

T0: 3-Step Mac Adam Ellipse+Main Lumen Bin (2700K~4000K)

S1: 5-Step Mac Adam Ellipse/ANSI+Full Lumen Bins (2700K~4000K)

F1: 5-Step Mac Adam Ellipse+Full Lumen Bins (5000K~5700K)

S1: ANSI+Full Lumen Bins (5000K~5700K)

LED HIGH POWER CoB Product Series

1.4 Product List

PN	Watt	CCT	CRI	Color Bin			Lumen Bin	
				3SDCM	5SDCM	7SDCM	-8%~+8%	-15%~+15%
LTPL-M02520ZS27-T0	20	2700K	80	☆			☆	
LTPL-M02520ZS27-S1	20	2700K	80		☆	☆		☆
LTPL-M02520ZS30-T0	20	3000K	80	☆			☆	
LTPL-M02520ZS30-S1	20	3000K	80		☆	☆		☆
LTPL-M02520ZS40-T0	20	4000K	80	☆			☆	
LTPL-M02520ZS40-S1	20	4000K	80		☆	☆		☆
LTPL-M02520ZS50-F1	20	5000K	80		☆		☆	
LTPL-M02520ZS50-S1	20	5000K	80			☆		☆
LTPL-M02520ZS57-F1	20	5700K	80		☆		☆	
LTPL-M02520ZS57-S1	20	5700K	80			☆		☆
LTPL-M02530ZS27-T0	30	2700K	80	☆			☆	
LTPL-M02530ZS27-S1	30	2700K	80		☆	☆		☆
LTPL-M02530ZS30-T0	30	3000K	80	☆			☆	
LTPL-M02530ZS30-S1	30	3000K	80		☆	☆		☆
LTPL-M02530ZS40-T0	30	4000K	80	☆			☆	
LTPL-M02530ZS40-S1	30	4000K	80		☆	☆		☆
LTPL-M02530ZS50-F1	30	5000K	80		☆		☆	
LTPL-M02530ZS50-S1	30	5000K	80			☆		☆
LTPL-M02530ZS57-F1	30	5700K	80		☆		☆	
LTPL-M02530ZS57-S1	30	5700K	80			☆		☆

LED HIGH POWER CoB Product Series

2. Outline Dimensions

20W Product

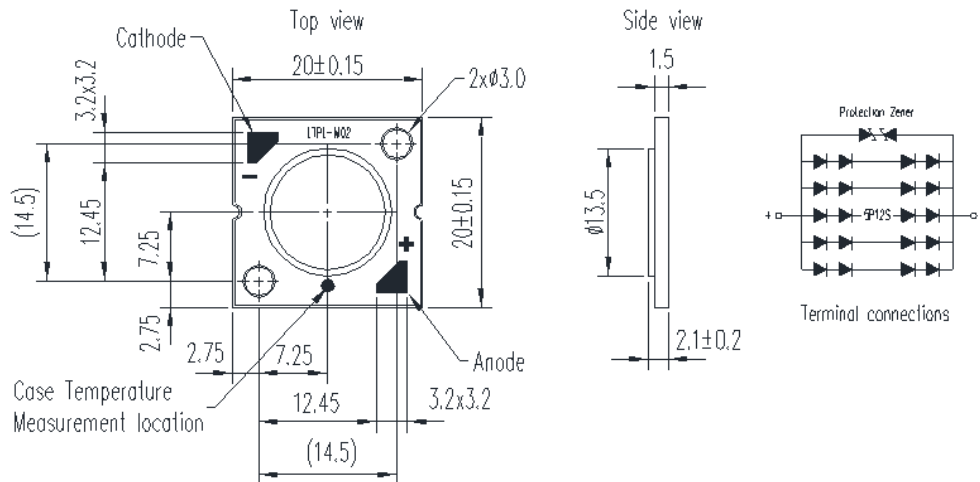

30W Product

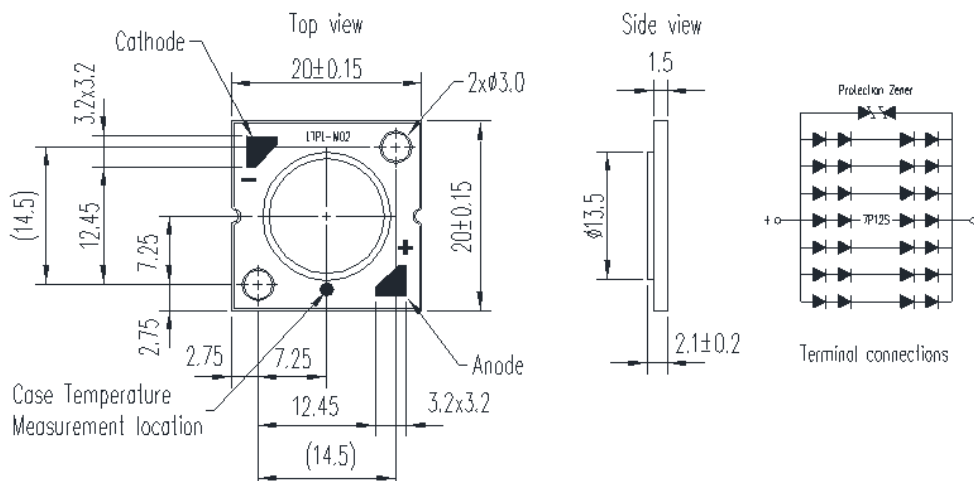

1. All dimensions are in millimeters.
2. Tolerance is ± 0.2 mm (0.008") unless otherwise noted.
3. LED of equivalent circuit means all series/parallel in CoB package.

LED HIGH POWER CoB Product Series

3. Absolute Maximum Ratings at Ta=25°C

Parameter	Symbol	Watt	Rating	Unit
Power Dissipation	P _o	20	32.0	W
		30	44.8	
Forward Current	I _F	20	800	mA
		30	1120	
Reverse Voltage	V _R		45	V
Junction Temperature	T _j		125	°C
Thermal Resistance, Junction-Case	R _{th, J-C}	20	1.20	°C / W
		30	0.80	
Operating Temperature Range	T _{opr}		-40 to 85	°C
Storage Temperature Range	T _{stg}		-40 to 100	°C
Breakdown Voltage(DC)	V _B		2.25	KV
Electrostatic Discharge	ESD		8	KV

Notes

1. The pulse mode condition is 1/10 duty cycle with 100 msec pulse width.
2. Forbid to be operated at reverse voltage condition.
3. ESD spec is reference to AEC-Q101-001 HBM.
4. The unit of R_{th} is °C/W electrical.
5. The M02 CoB is recommended soldering temperature under 350degC and could not over 3.5sec.

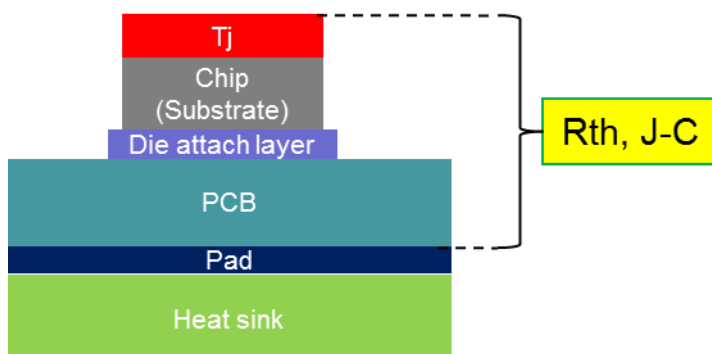

LED HIGH POWER CoB Product Series

4. Electro-Optical Characteristics

4.1 Typical Performance

Dominant CCT	Watt	Current (mA)	VF (V) @25°C	Flux(lm) @25°C	VF (V) @85°C	Flux(lm) @85°C	Eff.(lm/W) @25°C	Eff.(lm/W) @85°C
2700K	20	480	35.7	2139	34.6	1925	125	116
	30	720	35.9	3135	34.8	2822	121	113
3000K	20	480	35.7	2252	34.6	2026	131	122
	30	720	35.9	3300	34.8	2970	128	118
4000K	20	480	35.7	2387	34.6	2148	139	129
	30	720	35.9	3498	34.8	3148	135	126
5000K	20	480	35.7	2454	34.6	2209	143	133
	30	720	35.9	3597	34.8	3237	139	129
5700K	20	480	35.7	2285	34.6	2057	133	124
	30	720	35.9	3350	34.8	3015	130	120

Notes

1. All of VF value are typical, the real range is 33.0-39.8 volt, please refer page 20 "VF Binning Parameter".
2. All of Flux value are typical, the real Bin range please refer page 13 "Flux Binning Parameter".
3. Tolerance of flux is $\pm 7\%$, tolerance of CCX/CCY is ± 0.007 , tolerance of CRI is ± 2 .
4. Typical viewing angle is 120deg.
5. R9>0 for CRI80 product.

LED HIGH POWER CoB Product Series

4.2 Forward Current vs. Lumen Voltage

■ 20W Series Product

Current (mA)	VF (V)	Lumen (lm)				
		2700K	3000K	4000K	5000K	5700K
350	34.7	1607	1692	1793	1844	1717
400	35.1	1819	1915	2030	2088	1944
450	35.4	2025	2132	2260	2324	2164
480	35.7	2139	2252	2387	2454	2285
500	35.8	2215	2331	2471	2541	2366
550	36.2	2418	2544	2697	2773	2583
600	36.5	2617	2755	2921	3003	2797
650	36.8	2796	2943	3120	3208	2988
700	37.2	2970	3126	3313	3407	3173
750	37.5	3173	3339	3539	3640	3389

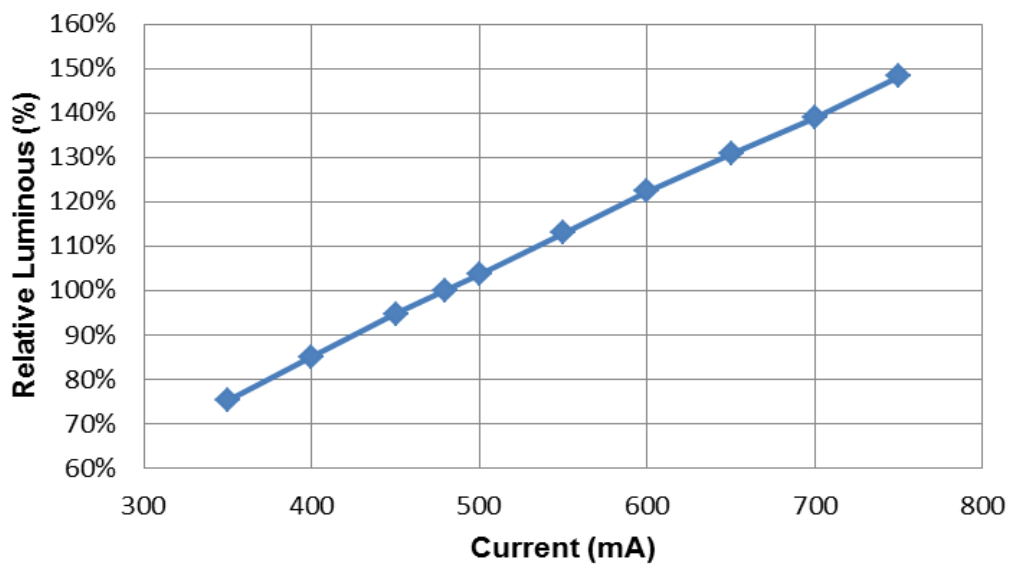

LED HIGH POWER CoB Product Series

■ 30W Series Product

Current (mA)	VF (V)	Lumen (lm)				
		2700K	3000K	4000K	5000K	5700K
490	34.7	2217	2334	2474	2544	2369
560	35.1	2511	2643	2802	2881	2683
630	35.4	2794	2941	3118	3206	2986
700	35.8	3057	3218	3411	3507	3266
720	35.9	3135	3300	3498	3597	3350
770	36.2	3337	3512	3723	3828	3565
840	36.5	3612	3802	4030	4144	3859
910	36.8	3858	4061	4305	4427	4122
980	37.2	4097	4313	4572	4701	4378
1050	37.5	4378	4608	4884	5023	4677

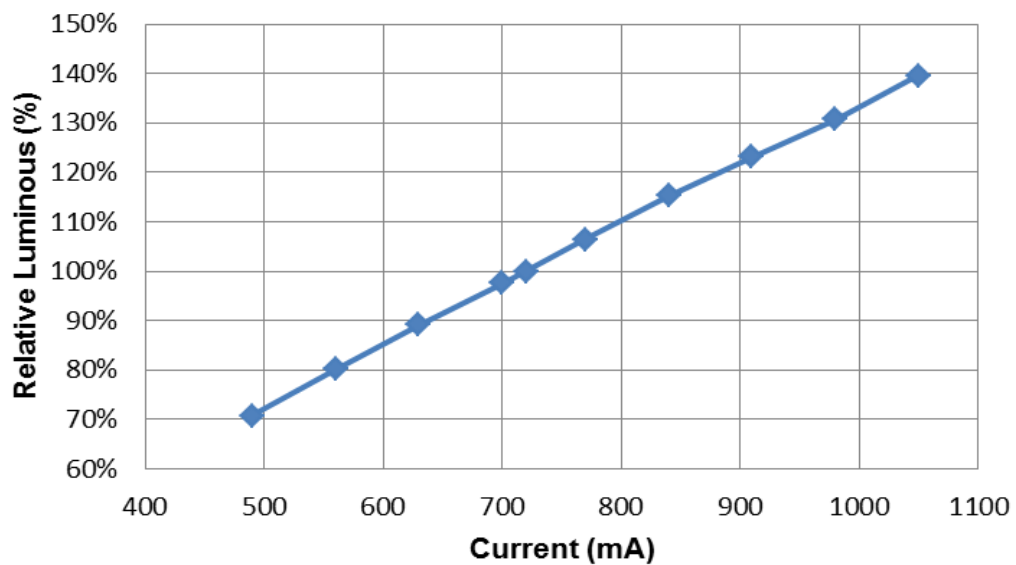

LED HIGH POWER CoB Product Series

4.3 Relative Spectral Power Distribution at Typical Current

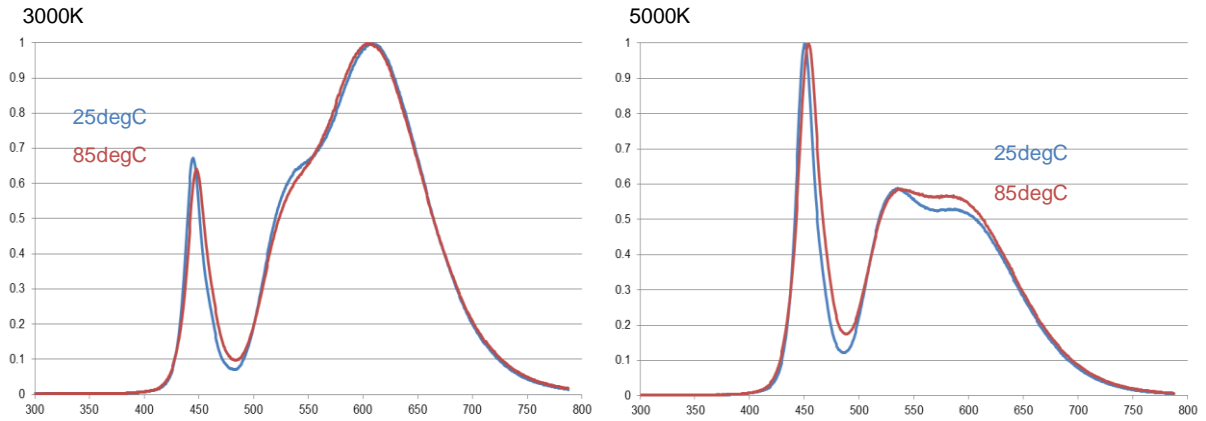

4.4 Radiation Characteristics

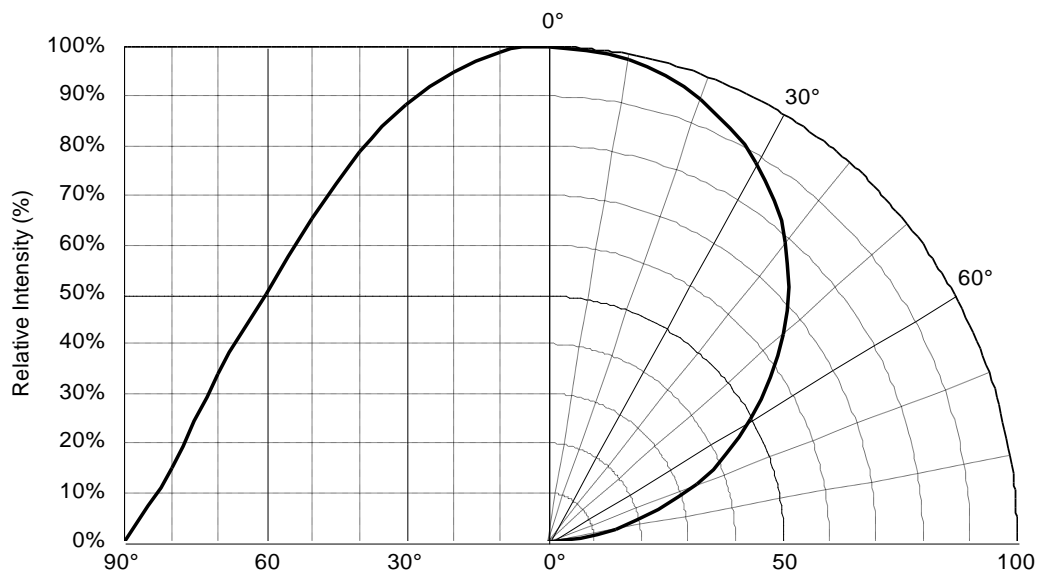

LED HIGH POWER CoB Product Series

4.5 Forward Current vs. Forward Voltage

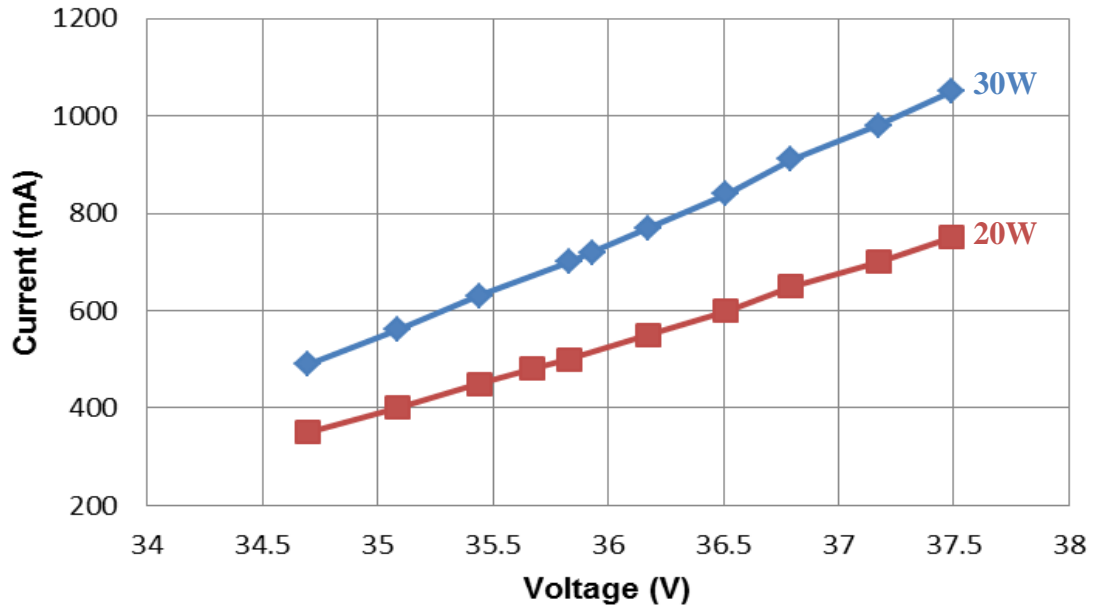

4.6 Forward Current Degrading Curve

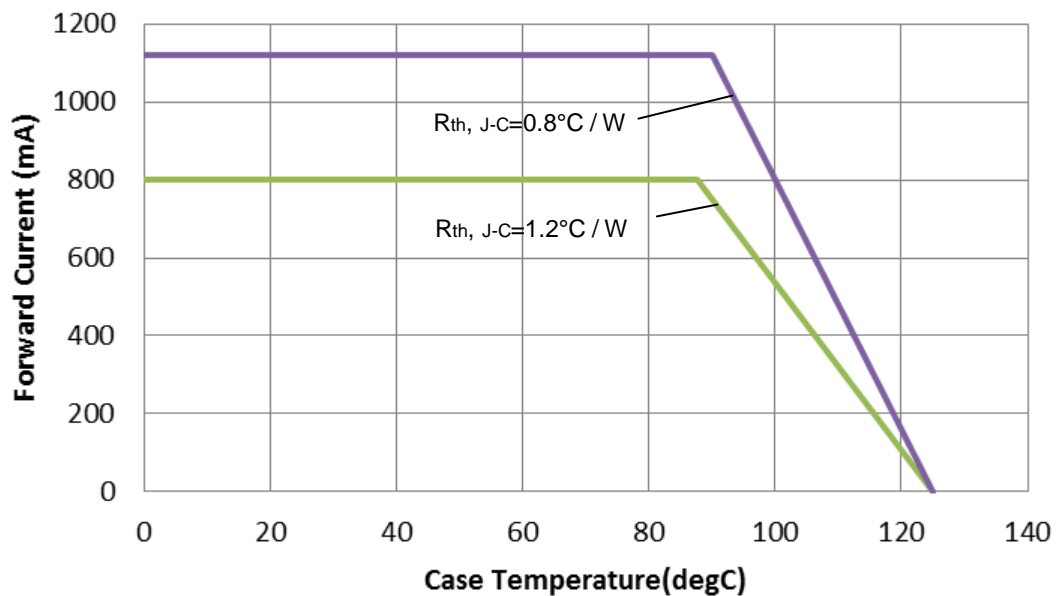

**LED HIGH POWER
CoB Product Series**

4.7 Relative Intensity vs. Case Temperature

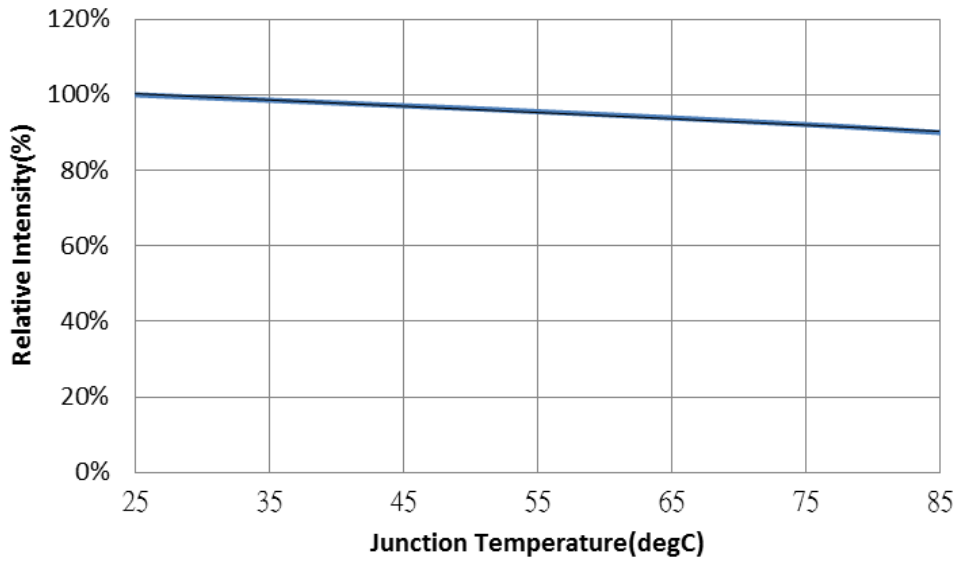

LED HIGH POWER CoB Product Series

4.8 Forward Voltage vs. Case Temperature/Junction Temperature

20W Series Product (Typical Current=480mA)			
Tc(°C)	Tj(°C)	VF (V)	%
25.0	45.5	35.7	100.00%
50.0	70.5	35.1	98.30%
75.0	95.5	34.6	97.00%
85.0	105.5	34.4	96.50%

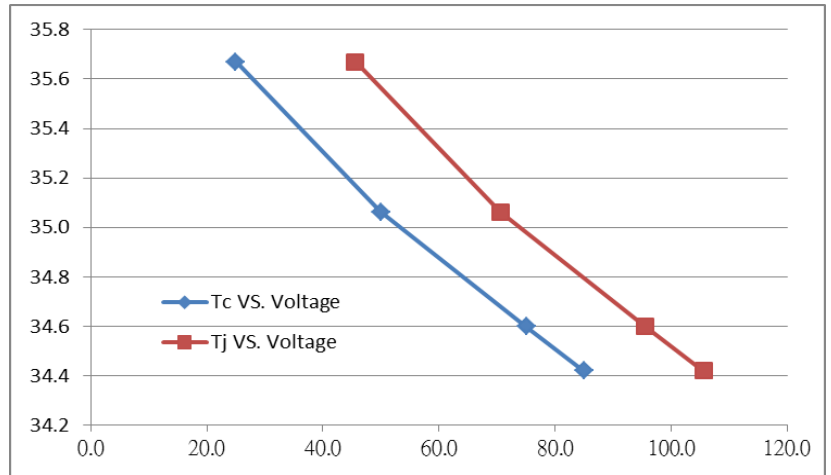

30W Series Product (Typical Current=720mA)			
Tc(°C)	Tj(°C)	VF (V)	%
25.0	45.7	35.9	100.00%
50.0	70.7	35.3	98.30%
75.0	95.7	34.9	97.00%
85.0	105.7	34.7	96.50%

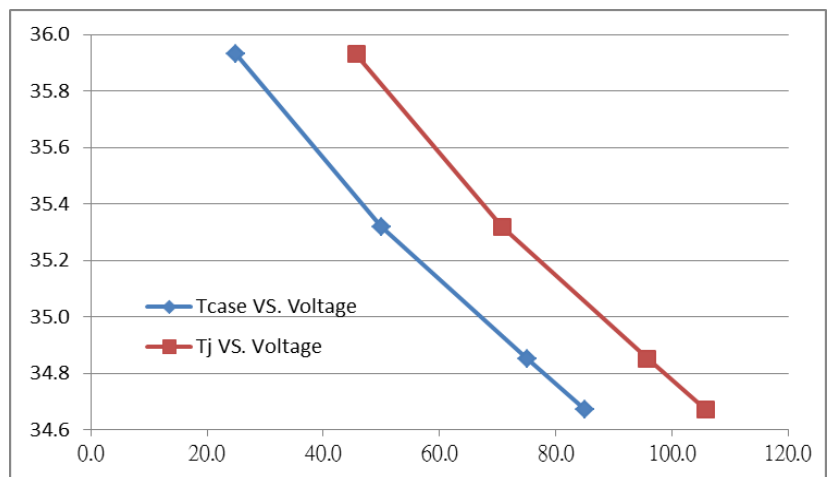

LED HIGH POWER CoB Product Series

5. CoB Binning Definition

Flux Binning Parameter (25degC)

Lumen CODE List of M02 Series Product			
Parameter	Code	Unit	Lumen
Luminous Flux	C	lm	1830
	D		1975
	E		2130
	F		2300
	G		2485
	H		2680
	I		2890
	J		3120
	K		3370
	L		3640
	M		3925
	N		4240

Example of M02 Series Product Bin (2700K 20W series)

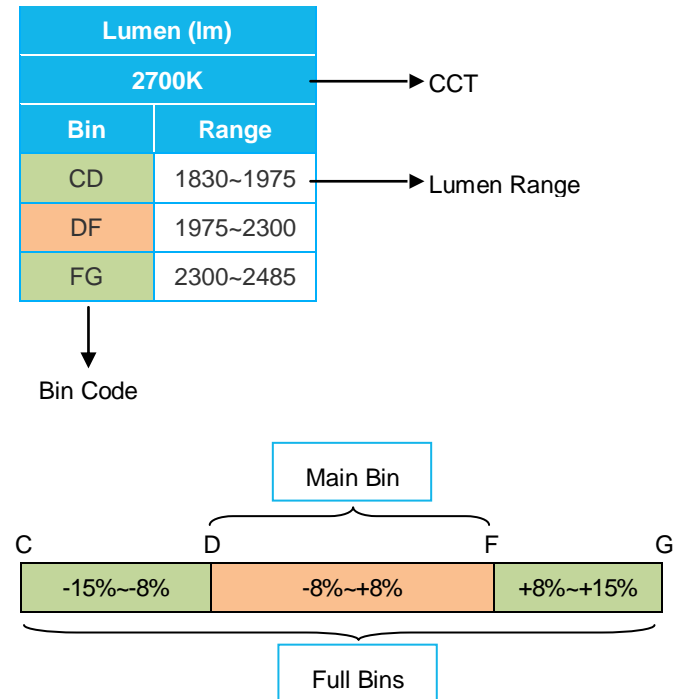

20 Series Lumen Bin

Lumen (lm)									
2700K		3000K		4000K		5000K		5700K	
Bin	Range	Bin	Range	Bin	Range	Bin	Range	Bin	Range
CD	1830~1975	CD	1830~1975	DE	1975~2130	EF	2130~2300	DE	1975~2130
DF	1975~2300	DF	1975~2300	EG	2130~2485	FH	2300~2680	EG	2130~2485
FG	2300~2485	FG	2300~2485	GH	2485~2680	HI	2680~2890	GH	2485~2680

30 Series Lumen Bin

Lumen (lm)									
2700K		3000K		4000K		5000K		5700K	
Bin	Range	Bin	Range	Bin	Range	Bin	Range	Bin	Range
HI	2680~2890	IJ	2890~3120	JK	3120~3370	JK	3120~3370	IJ	2890~3120
IK	2890~3370	JL	3120~3640	KM	3370~3925	KM	3370~3925	JL	3120~3640
KL	3370~3640	LM	3640~3925	MN	3925~4240	MN	3925~4240	LM	3640~3925

LED HIGH POWER CoB Product Series

■ Example of LiteOn CoB MacAdam Ellipse Color Definition (EX: 2700K)

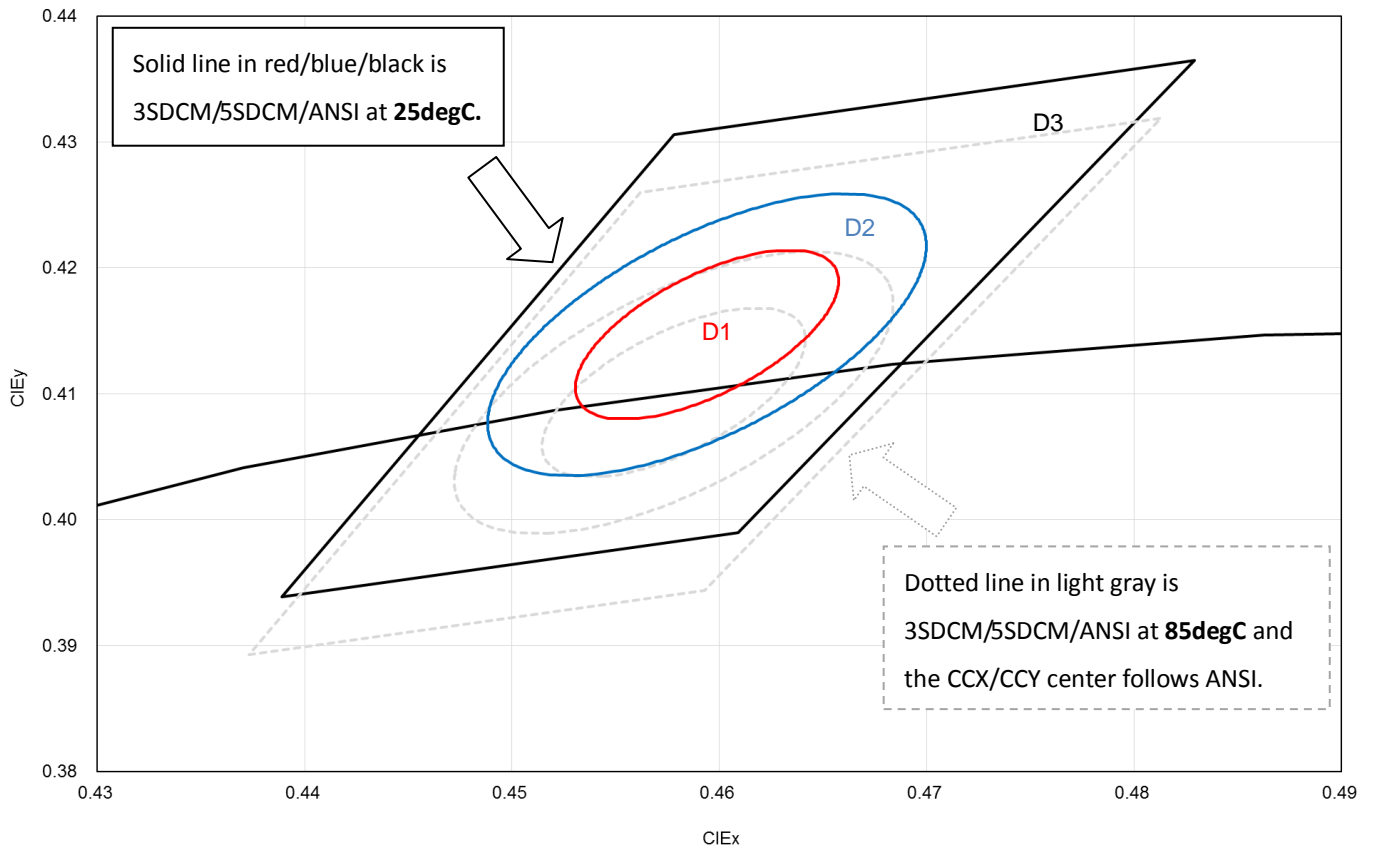

CIE Center Point						
CCT	25degC (LiteOn Spec.)		85degC (ANSI)		Hot/Cold Factor	
	CCX	CCY	CCX	CCY	CCX	CCY
2700	0.4594	0.4147	0.4578	0.4101	-0.0016	-0.0046
3000	0.4369	0.4067	0.4338	0.4030	-0.0031	-0.0037
4000	0.3856	0.3844	0.3818	0.3797	-0.0038	-0.0047
5000	0.3489	0.3603	0.3447	0.3553	-0.0042	-0.0050
5700	0.3322	0.3417	0.3287	0.3417	-0.0035	-0.0054

Notes

1. LiteOn tester and shipping spec follow the color bin with 25degC CCX/CCY center.
2. The Hot/Cold factor means the CCX/CCY shift from 25degC to 85degC.
3. The Hot/Cold shift is measured by LiteOn CAS 140B instrument system.
4. The ellipse equation expression: $SDCM = (g11*(x-x_0)^2 + 2*g12*(x-x_0)*(y-y_0) + g22*(y-y_0)^2)^{0.5}$

LED HIGH POWER CoB Product Series

■ M02 CRI80 2700K

PN: LTPL-M025XXZS27-T0

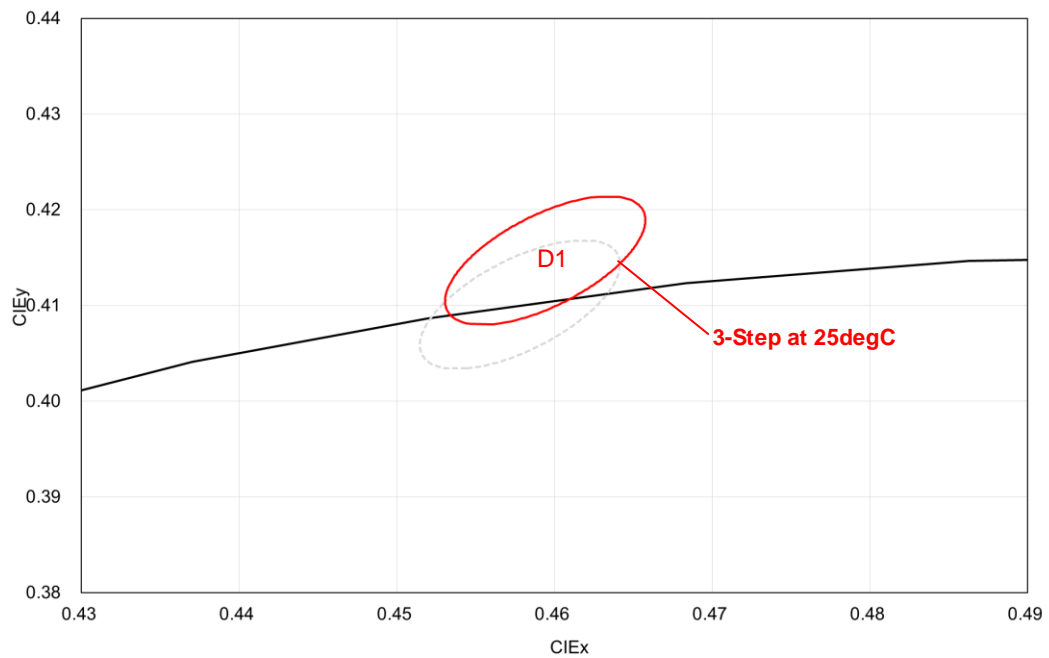

PN: LTPL-M025XXZS27-S1

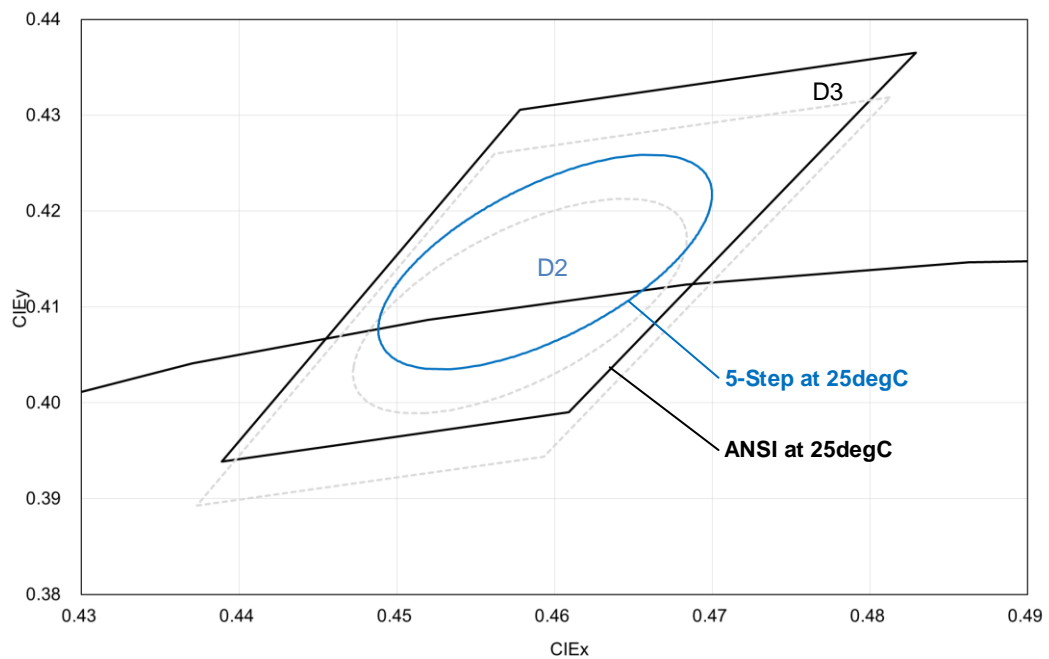

LED HIGH POWER CoB Product Series

■ M02 CRI80 3000K

PN: LTPL-M025XXZS30-T0

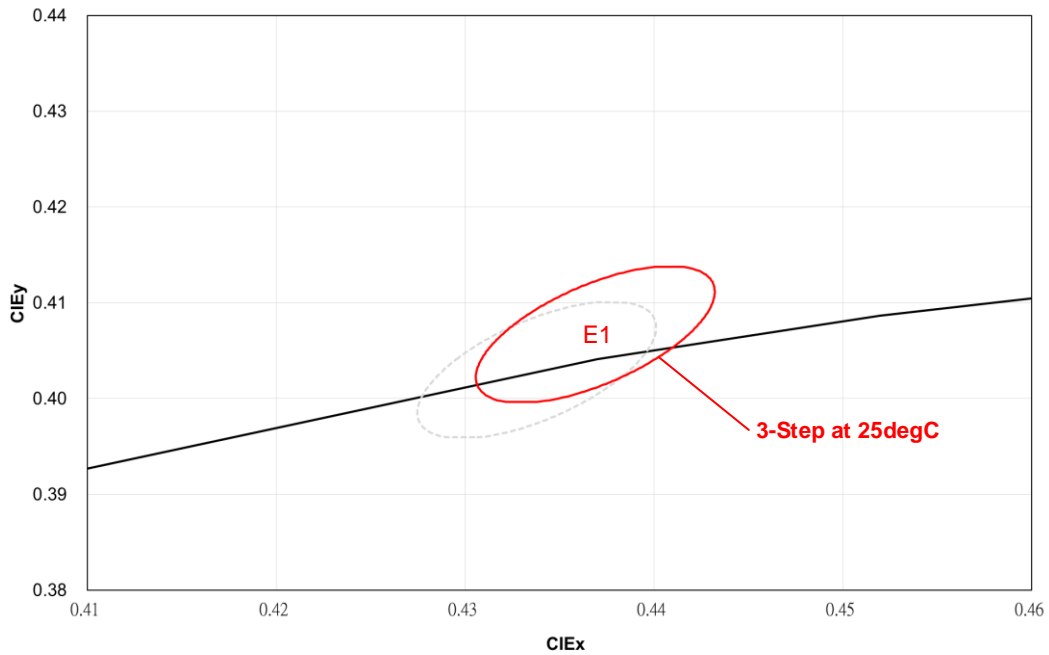

PN: LTPL-M025XXZS30-S1

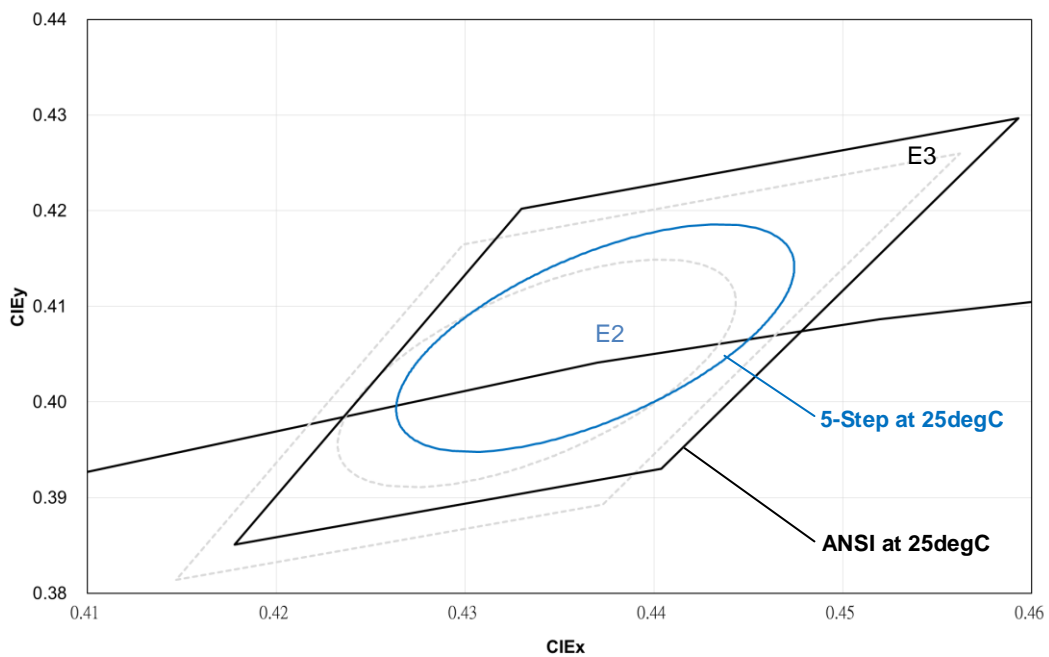

LED HIGH POWER CoB Product Series

■ M02 CRI80 4000K

PN: LTPL-M025XXZS40-T0

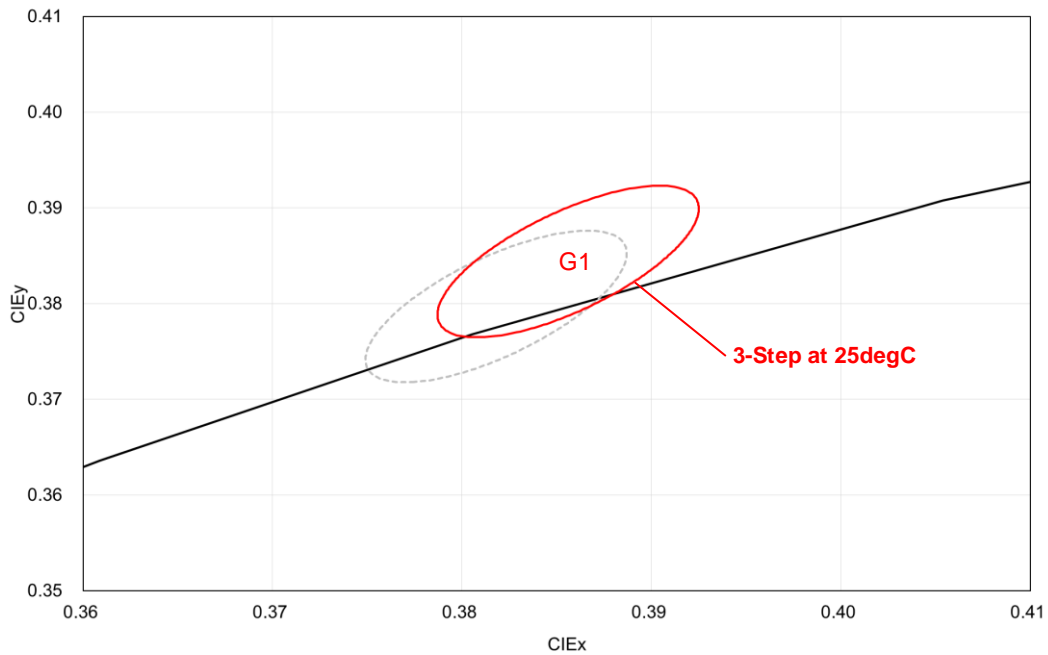

PN: LTPL-M025XXZS40-S1

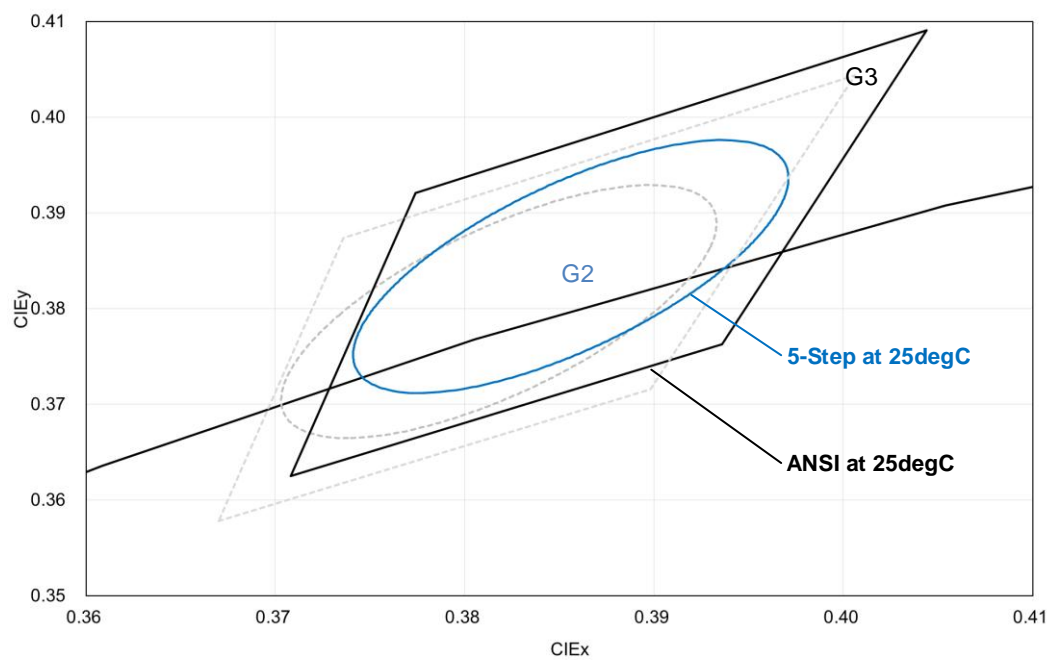

**LED HIGH POWER
CoB Product Series**

■ **M02 CRI80 5000K**

PN: **LTPL-M025XXZS50-F1**

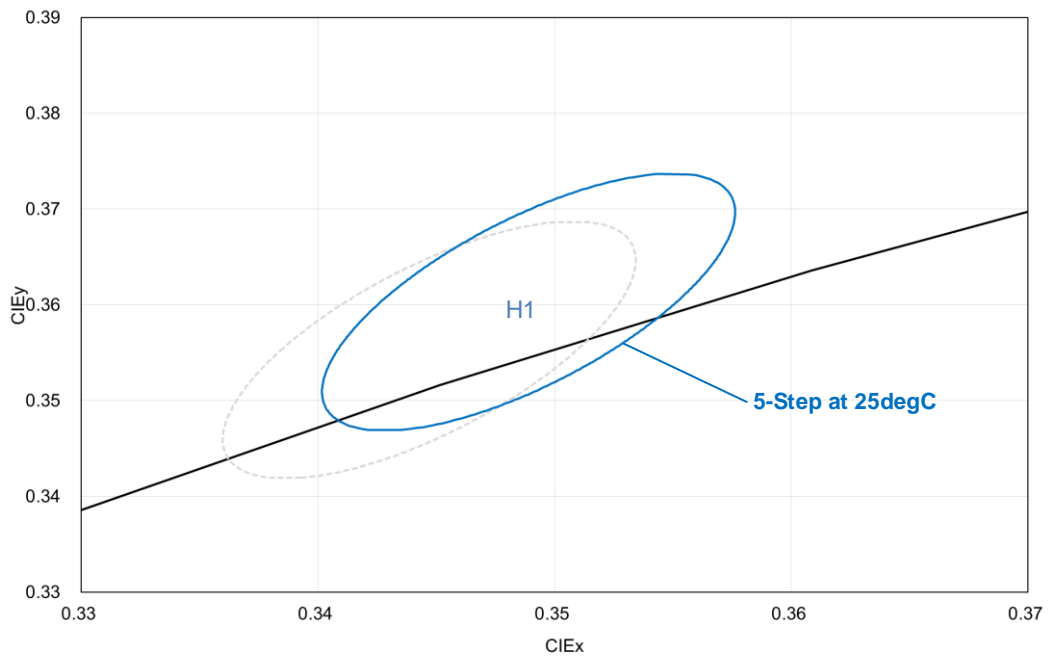

PN: **LTPL-M025XXZS50-S1**

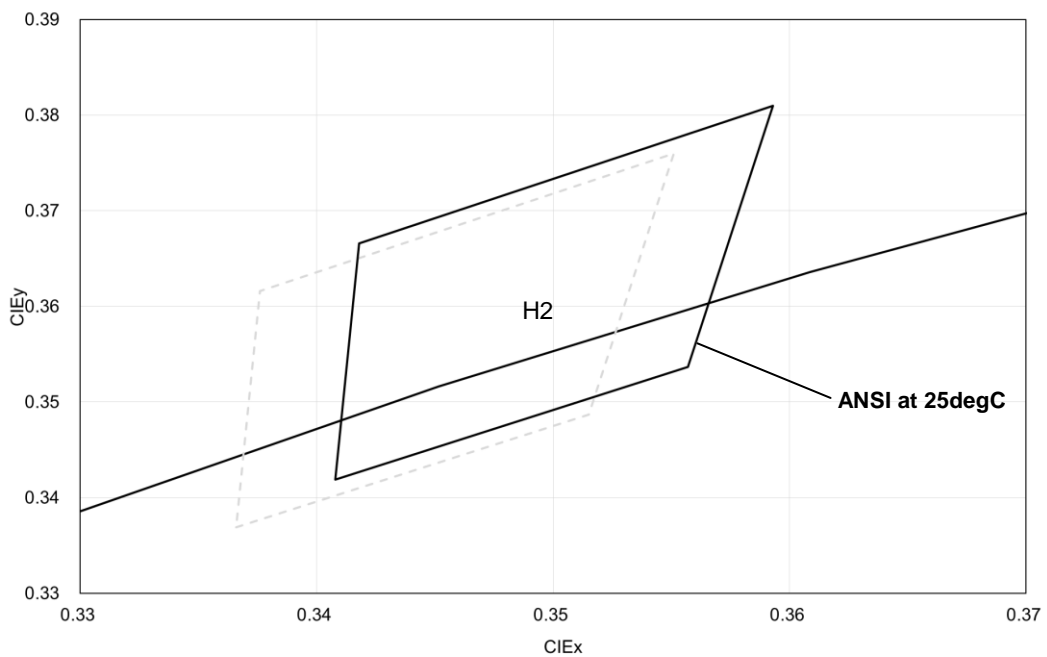

LED HIGH POWER CoB Product Series

■ M02 CRI80 5700K

PN: LTPL-M025XXZS57-F1

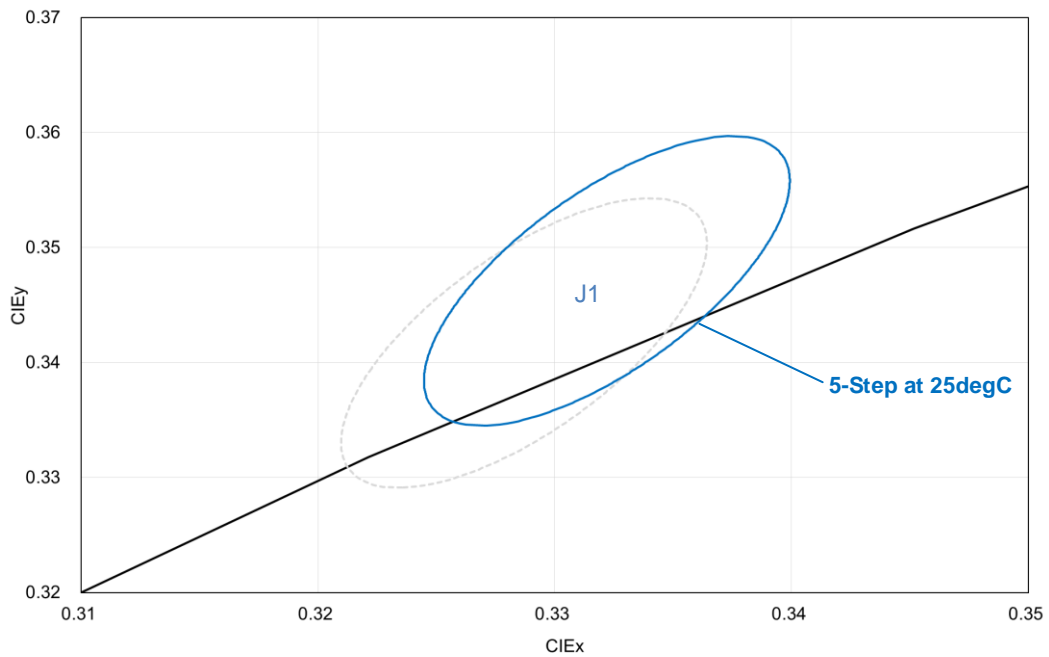

PN: LTPL-M025XXZS57-S1

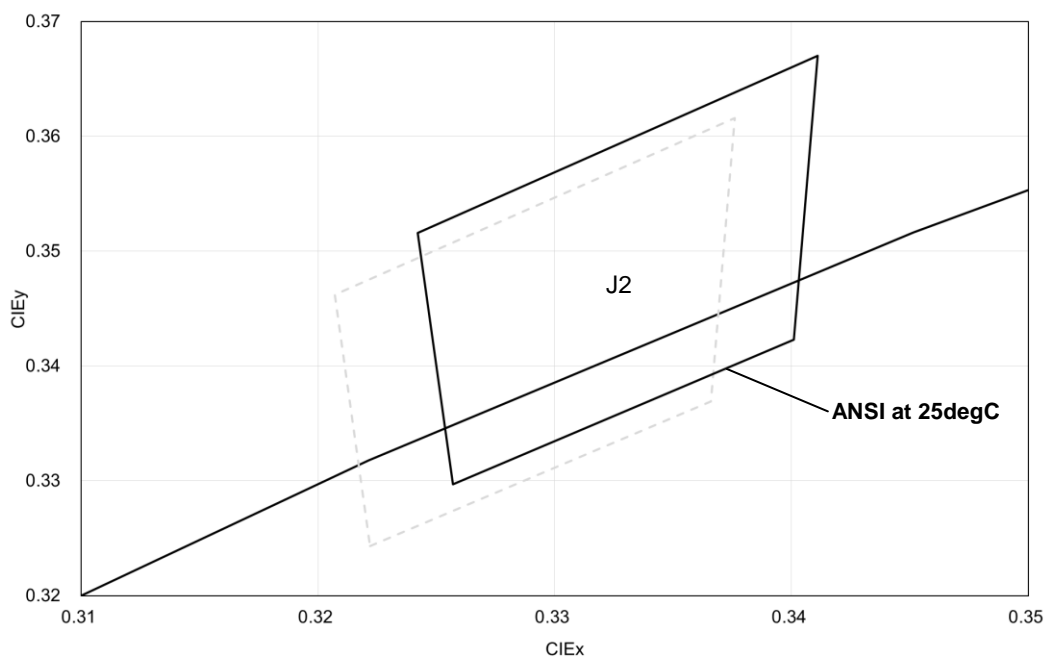

LED HIGH POWER CoB Product Series

■ Forward Voltage Binning Parameter (25degC)

Parameter	Bin	Symbol	Min	Max	Unit	Condition
Forward Voltage	V1	V _F	33.0	39.8	V	I _F = Typical Current

Note: Full Rank on Label

Example: V1/DF/D1

Forward Voltage Rank	Luminous Flux Rank	Color Rank
V1	DF	D1

LED HIGH POWER CoB Product Series

6. Reliability Test Plan

No	Test item	Condition	Duration	Result
1	High Temperature Operating Life	Tc=85°C, IF=Typical Current	1K hours	Pass
2	Wet High Temperature Operating Life	60°C/90%RH, IF=Typical Current(DC) 30 min ON/OFF	1K hours	Pass
3	Thermal Shock	-40°C to 125°C, 15minutes dwell, <10 seconds transfer, measurement in every 250 cycle	500 cycles	Pass
4	Fast Switch Cycling Test	40000cycles, 2 mins On/Off, Room temperature(25°C+/-5C), measurement in every 5000 cycle	40K cycles	Pass
5	High Temperature Storage Life	Ta=120°C	1K hours	Pass
6	Low Temperature Storage Life	Ta=-55°C	1K hours	Pass
7	Mechanical Shock	1500G, 0.5ms pulse, 5 shocks each 6 axis	30 Times (5 shocks each 6 axis)	Pass
8	Variable Vibration Frequency	10-2000-10 Hz, log or linear sweep rate, 20G for approximately minute 1.5mm, each applied three times per axis over 6 hrs.	18 hrs (three times per axis over 6 hrs.)	Pass

Criteria for Judging the Damage

Item	Symbol	Test Condition	Criteria for Judgment	
			Min.	Max.
Forward Voltage	Vf	IF=Typical Current		U.S.L. x 1.1
Luminous Flux	Lm	IF=Typical Current	L.S.L. x 0.7	
CCX&CCY	X,Y	IF=Typical Current		Shift<0.02

Notes:

1. Operating life test are mounted on thermal heat sink
2. Storage item are only component, not put on heat sink.

LED HIGH POWER CoB Product Series

7. Packing Specifications

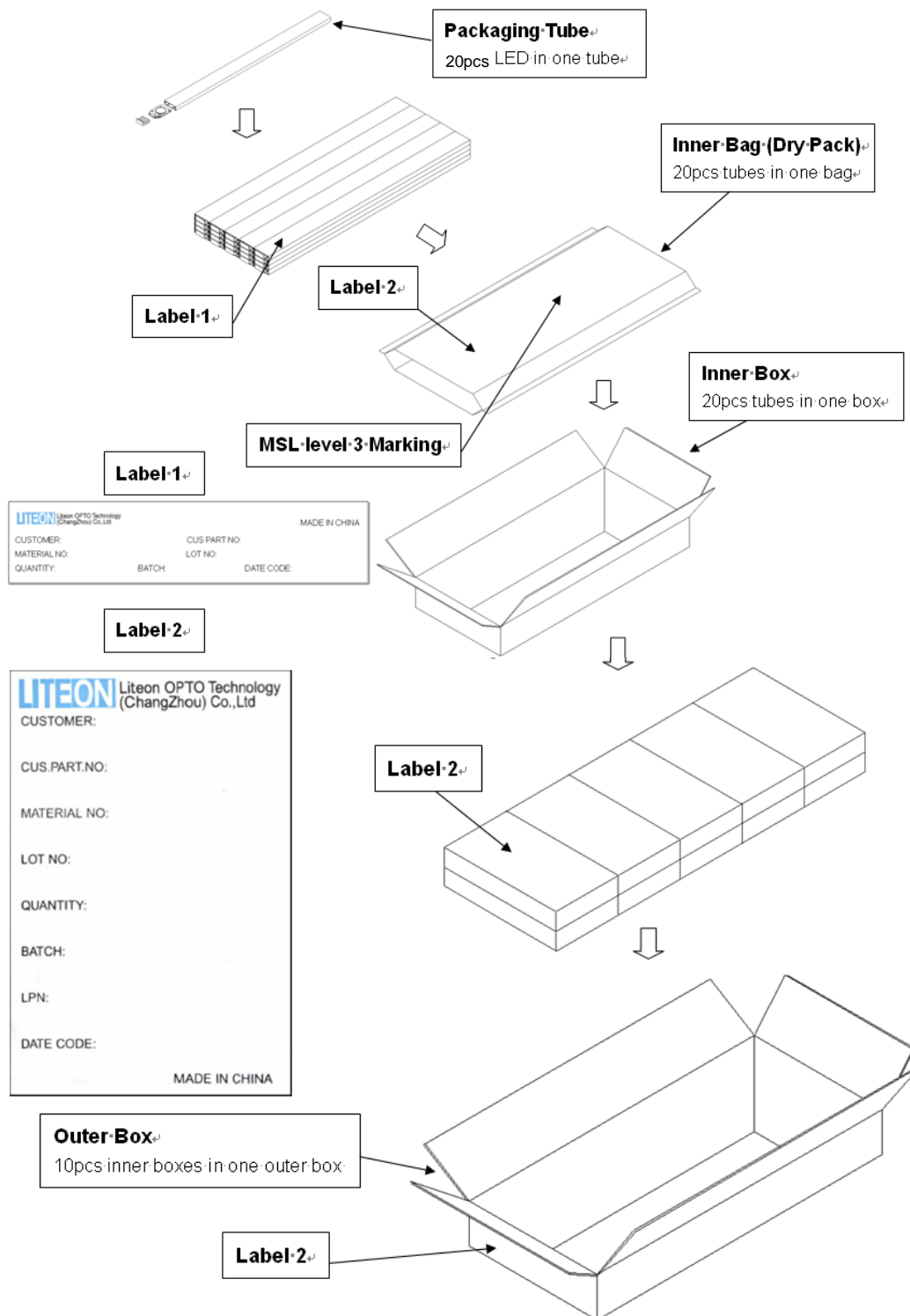

LED HIGH POWER CoB Product Series

8. Cautions

8.1 An LED is a current-operated device. In order to ensure intensity uniformity on multiple LEDs connected in parallel in an application, it is recommended that a current limiting resistor be incorporated in the drive circuit, in series with each LED as shown in Circuit below.

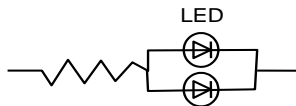

(A) Recommended circuit.

(B) The brightness of each LED might appear different due to the differences in the I-V characteristics of those LEDs.

8.2 Do not put any pressure on the light emitting surface either by finger or any hand tool and do not stack the COB products. Stress or pressure may cause damage to the wires of the LED array.

8.3 This product is not designed for the use under any of the following conditions, please confirm the performance and reliability are well enough if you use it under any of the following conditions

- Do not use sulfur-containing materials in commercial products including the materials such as seals and adhesives that may contain sulfur.
- Do not put this product in a place with a lot of moisture (over 85% relative humidity), dew condensation, briny air, and corrosive gas (Cl, H₂S, NH₃, SO₂, NO_x, etc.), exposure to a corrosive environment may affect silver plating.

ESD (Electrostatic Discharge)

Static Electricity or power surge will damage the LED. Suggestions to prevent ESD damage:

- Use of a conductive wrist band or anti-electrostatic glove when handling these LEDs.
- All devices, equipment, and machinery must be properly grounded.
- Work tables, storage racks, etc. should be properly grounded.
- Use ion blower to neutralize the static charge which might have built up on surface of the LED's plastic lens as a result of friction between LEDs during storage and handling.

ESD-damaged LEDs will exhibit abnormal characteristics such as high reverse leakage current, low forward voltage, or “no light up” at low currents.

To verify for ESD damage, check for “light up” and VF of the suspect LEDs at low currents.