

# Surge Protection and Power Supplies

2015/2016

6





# Surge protection and power supplies



## Terminal blocks

- Terminal blocks



## Interface technology and switching devices

- Electronic switching devices and motor control
- Measurement and control technology
- Monitoring
- Relay modules
- System cabling for controllers



## Sensor/actuator cabling and industrial connectors

- Sensor/actuator cabling
- Cables and lines
- Connectors



## Control technology, I/O systems, and automation infrastructure

- Lighting and signaling
- Fieldbus components and systems
- Functional Safety
- HMIs and industrial PCs
- I/O systems
- Industrial Ethernet
- Industrial communication technology
- Software
- Controllers
- Wireless data communication



## Marking systems, tools, and mounting material

- Marking and labeling
- Tools
- Installation and mounting material

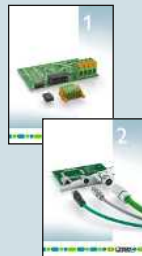

## PCB connection technology and electronics housing 2013/14

- PCB terminal blocks and PCB connectors
- Electronics housing



## Connection technology for field devices 2013/14

- Connectors
- Cables and lines

## Find out more with the web code

On some of the catalog pages, you can find our web codes: a number sign followed by a four-digit number combination.

**i** Web code: #1234 (example)

This allows you to reach information on our website quickly.

### It couldn't be simpler:

1. Go to the Phoenix Contact website
2. Enter # and the number combination in the search field
3. Receive more information and product versions



Or use the direct link:

[phoenixcontact.net/webcode/#1234](http://phoenixcontact.net/webcode/#1234)

Information on these products can be found in the electronic product catalogs for 2013/14.

Or get the latest on all the new products and additional information directly in the product area of our website:

[phoenixcontact.net/products](http://phoenixcontact.net/products)



Also discover the Phoenix Contact catalog app interactively on your tablet.

# Table of contents

---

## Overview

The table of contents will help you find the right product more quickly

4

---

## Lightning monitoring system



7

---

## Surge protection and interference suppression filters



13

---

## Power supplies and UPS



151

---

## Protective devices



247

---

## Technical information

270

---

## Index

284

# Introduction

## Product range overview

### Lightning monitoring system



LM-S Page 10

### Surge protection for the power supply with SEC technology



**Lightning arrester**  
FLASHTRAB SEC HYBRID ... Page 20  
FLASHTRAB SEC PLUS 440 ... Page 21  
FLASHTRAB SEC PLUS 350 ... Page 22



**Type 1 + 2 lightning and surge arrester combination**  
FLASHTRAB SEC T1+T2... Page 25



**Type 2 surge arrester + type 3 device protection**  
VALVETRAB SEC Page 28  
PLUGTRAB SEC Page 30

### Surge protection for the power supply



**Type 1 lightning arrester**  
POWERTRAB Page 34  
VALVETRAB MS T1/T2 Page 36



**Type 2 surge arrester**  
VALVETRAB MS Page 40



**Type 3 device protection**  
BLOCKTRAB Page 54  
MAINTRAB Page 56  
PLUGTRAB Page 54



**Set solutions**  
Building set PV-SET Page 39  
Page 58

### Surge protection for MCR technology



**DIN rail modules**  
PLUGTRAB Page 74  
LINETRAB Page 92  
TERMITRAB Page 94



**Special systems**  
LSA-PLUS modules Page 98  
Page 116



**For networks** Page 108  
**For interfaces** Page 109



**MAINTRAB** Page 56  
**PLUGTRAB PT-IQ** Page 80  
**Telecommunications systems** Page 56

### Surge protection for transceiver systems



**For mobile phone networks** Page 126  
**For video communication** Page 127



**For radio and television sets** Page 130



**CHECKMASTER 2** Page 136



**FLASHTRAB ISG** Page 140

**EMC solutions**



Mains interference filters with integrated surge protection Page 146  
Interference suppression filters Page 149

**Power supply units**



QUINT POWER Page 158  
QUINT POWER, with protective coating Page 166



TRIO POWER Page 168



UNO POWER Page 174

**DC/DC converters**



MINI POWER Page 182



STEP POWER Page 186



QUINT DC/DC converters Page 196  
QUINT DC/DC converters, with protective coating Page 202  
MINI DC/DC converter Page 204

**Redundancy modules**



QUINT ORING Page 208  
TRIO DIODE Page 210  
QUINT DIODE, UNO DIODE Page 212  
STEP DIODE Page 213

**UPS for the control cabinet**



QUINT UPS Page 220



Power storage for QUINT UPS Page 224



UPS with integrated power storage  
QUINT UPS Page 234  
QUINT BUFFER Page 235  
STEP UPS, UNO UPS Page 236



UPS with integrated power supply unit  
TRIO UPS Page 238  
MINI UPS Page 239

**UPS for 19" rack/tower**



UPS devices Page 244

**Protective devices**



CB device circuit breakers Page 252



CBM multi-channel electronic device circuit breakers Page 258



TCP thermal circuit breakers Page 262  
Fuse terminal blocks, see Catalog 3



# LM-S lightning monitoring system

Lightning strikes are a particular hazard for exposed structures such as offshore wind parks, radio masts, leisure facilities or high buildings.

The LM-S lightning monitoring system can detect and analyze lightning strikes in realtime. It provides information online about the intensity of the strike based on the typical lightning parameters. By consolidating the system operating parameters and the measuring data, the system provides a better basis for making decisions regarding control and maintenance.

 **Your web code: #0141**

## Lightning monitoring system

<b>Introduction</b>	<b>8</b>
<b>LM-S</b>	
Sensor	<b>10</b>
Connecting cable	<b>10</b>
Evaluation unit	<b>11</b>
Optoelectronic module	<b>11</b>



Lightning strikes cause devastating damage to buildings and systems. It is practically impossible for employees to continuously monitor exposed or large-scale systems, which means that damage is detected too late.

### **Detecting lightning with the lightning monitoring system**

The LM-S lightning monitoring system supports continuous monitoring. Lightning events are detected, evaluated, and remotely monitored via network access. By consolidating the system operating parameters and the measuring data, the system provides a better basis for making decisions regarding control and maintenance.

The LM-S lightning monitoring system consists of the following components:

- Sensor
- Connecting cable
- O/E module
- Evaluation unit



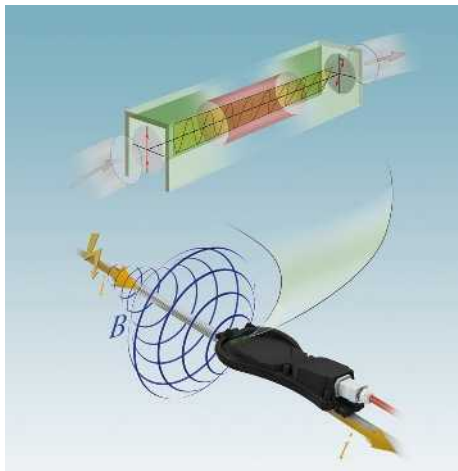

### Faraday effect as a reliable measuring method

The internal measuring principle of the LM-S is based on the Faraday effect. Polarized light in a specific medium is rotated through a magnetic field over a defined length and measured.

The higher the amperage ( $i$ ) generated by a lightning strike the greater the magnetic flux density ( $B$ ) and, therefore, the rotation of the polarized light.

The lightning monitoring system detects this change in the light signal and uses this as the basis for the corresponding measured value results.

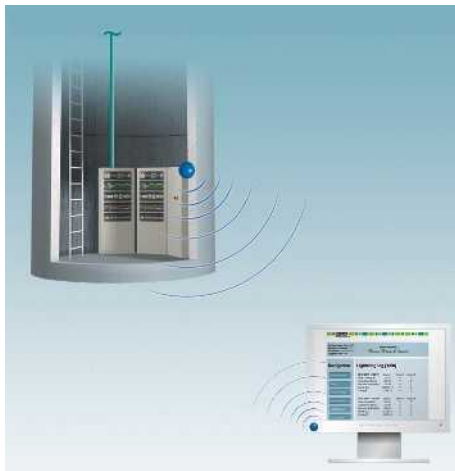

### Remote monitoring in realtime

The evaluation unit can be easily integrated into standard network systems via the RJ45 Ethernet interface. An internal web server is used as the basis for accessing recorded data and configuring the system. The web interface is opened via the Internet browser of a PC connected to the system using IP addressing.

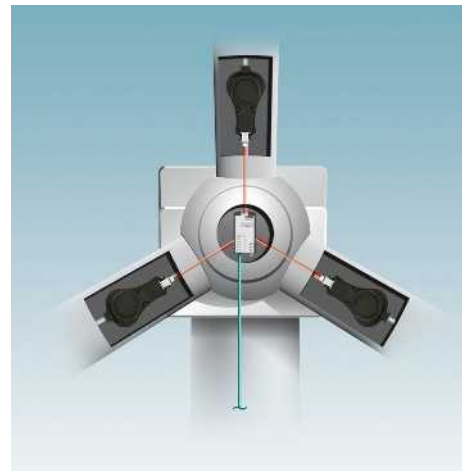

### Detection and evaluation

The sensors are mounted on the lightning arrester cables. They record the magnetic field that occurs around the conductor due to the lightning surge current. The measured result is transmitted via fiber optics to the O/E module of the evaluation unit, where the optical signal is converted into an electrical signal. Based on the values obtained, the evaluation unit determines the lightning characteristics with their typical parameters, including, for example, the maximum lightning current strength, lightning current rate of rise, charge, and energy. These results can be forwarded to an existing management system via the Ethernet interface.

# Lightning monitoring

## LM-S

### Sensor

- Optical lightning sensor for measuring current strength of lightning surge currents
- Subsequent mounting is possible
- Resistant to humidity
- Good UV resistance



Sensor

Technical data			
Detectable values			
Maximum current strength	250 kA		
FO interface			
Connection method	SC-RJ socket with push-pull connector, IP67		
General data			
Ambient temperature (operation)	-30°C ... 60°C		
Ambient temperature (storage/transport)	-40°C ... 85°C		
Degree of protection	IP67		
Ordering data			
Description	Type	Order No.	Pcs. / Pkt.
<b>Sensor</b>	<b>LM-S-LS-H</b>	<b>2800616</b>	<b>1</b>

### Connecting cable

- HCS cable for connecting LM-S sensors to the O/E module
- Good UV resistance
- Good oil resistance

**Notes:**  
The specified plug configuration (see ordering example) must be used in order to use the connecting cable in the LM-S lightning monitoring system.  
Recommended length: 10 to 200 m



Connecting cable for LM-S

### Ordering example for LM-S connecting cable with variable cable length:

Assembled connecting cable for the LM-S lightning monitoring system, with a metal push-pull connector, a B-FOC plug, and a cable length of 10 m.

Order No.	Length [m]
1417723 / FOC-SJ:14-ST/HB02	10.0
	<b>Increments:</b> 10.0 m ... 200 m = 1.0 m

Ordering data			
Description	Type	Order No.	Pcs. / Pkt.
<b>Connecting cable</b> , variable, for Industrial applications, green	<b>FOC-SJ:14-ST/HB02/...</b>	<b>1417723</b>	<b>1</b>
Wind power plants, black	<b>FOC-SJ:14-ST/HB07/...</b>	<b>1417723</b>	<b>1</b>

## Evaluation unit

- Complete module including O/E module for connecting up to three LM-S sensors
- Evaluation and storage of amperage, current rate of rise, charge, and specific energy
- Realtime analysis and exact time allocation
- Status and diagnostics indicators
- Communication via Ethernet
- Operation and configuration via web interface
- Mounting on a DIN rail



Evaluation unit with O/E module

Technical data	
Operating voltage	24 V DC $\pm$ 4 V
Ethernet ports	
Connection method	RJ45
Transmission speed	10/100 Mbps
FO interface	
Interface	B-FOC (ST®)
Number of ports	3
Sensor interfaces	
Connection method	Rack for plug-in I/O module
Remote indication contact	
Connection method	M12 D-coded
Max. operating voltage	60 V DC
General data	
Ambient temperature (operation)	-30°C ... 60°C
Degree of protection	IP20

Ordering data			
Description	Type	Order No.	Pcs. / Pkt.
Evaluation unit with O/E module	LM-S-A/C-3S-ETH	2800618	1

## Optoelectronic module

- Replacement O/E module for evaluation unit
- Connection of up to three LM-S sensors
- Status and diagnostic display via evaluation unit



O/E module

Technical data	
FO interface	
Interface	B-FOC (ST®)
Number of ports	3
General data	
Ambient temperature (operation)	-30°C ... 60°C
Ambient temperature (storage/transport)	-40°C ... 85°C
Degree of protection	IP20

Ordering data			
Description	Type	Order No.	Pcs. / Pkt.
Optoelectronic module	LM-S-C-3LS	2800617	1



# Surge protection and interference suppression filters

## Damage caused by surge voltages

The number of electrical devices damaged or destroyed by surge voltages is increasing year on year. This can prove expensive in terms of repairs and downtimes. In an industrial environment, the hazards are not only restricted to systems and devices. Building technology applications and even residential buildings may be affected.

## Interference voltages

Switching operations triggered mechanically or electronically generate pulse-like and high-frequency interference voltages. These voltages spread in an unimpeded manner across the cable network. All the devices within this cable network are affected. Data errors, uncontrolled functions, and system crashes can result, with electronic and data processing devices at particular risk.

 Your web code: [#0142](#)

<b>Selection guides</b>	<b>14</b>
<hr/>	
<b>Surge protection for the power supply with Safe Energy Control</b>	<b>18</b>
Type 1	20
Type 1 + 2	25
Type 2	28
Type 3	30
<hr/>	
<b>Surge protection for the power supply</b>	<b>32</b>
Type 1	34
Type 1/2	36
Type 2	40
Type 3	54
Photovoltaic arresters	58
Applications	62
<hr/>	
<b>Surge protection for MCR technology</b>	<b>70</b>
Selection guide	72
DIN rail modules	74
PLUGTRAB PT-IQ, PLUGTRAB PT, LINETRAB, TERMITRAB	98
Special systems	
SURGETRAB	
Applications	100
<hr/>	
<b>Surge protection for information technology and telecommunications</b>	<b>104</b>
Selection guide	106
Bus systems	108
Telecommunications	114
Applications	120
<hr/>	
<b>Surge protection for transceiver systems</b>	<b>122</b>
Selection guide	124
Transceiver technology	126
TV and radio systems	127
Applications	58
<hr/>	
<b>Accessories for surge protection</b>	<b>134</b>
<hr/>	
<b>Test device for arresters</b>	<b>136</b>
<hr/>	
<b>Isolating spark gap</b>	<b>140</b>
<hr/>	
<b>Interference suppression filters</b>	<b>144</b>
Filters with type 3 surge protection	146
Filters	149

# Surge protection and interference suppression filters

## Selection guide for the power supply

The selection matrix makes it easy to select suitable surge protection for the desired application.

Further application recommendations, in particular for DC applications, on request.

### Network type

TN-S/TT  
3-phase



TN-C  
3-phase



TN-S/TT  
2-phase



TN-C  
2-phase



TN-S/TT  
1-phase



TN-C  
1-phase



TN-S/TT  
End devices



### Note

Products bearing this stamp (plug elements) can be tested with the CHECKMASTER.

Surge protection for the power supply							
Network type			IEC test classification/EN type				
			I / T1	I / T1+	I+II / T1+T2	II / T2	III / T3
230 / 400 V	3-phase	TN-S/TT	✓				
				✓			
					✓		
		TN-C	✓				
				✓			
					✓		
	2-phase	TN-S/TT	✓				
				✓			
					✓		
		TN-C	✓				
				✓			
					✓		
1-phase	TN-S/TT	✓					
			✓				
				✓			
	TN-C	✓					
			✓				
				✓			

Surge protection for the power supply							
Network type			IEC test classification/EN type				
			I / T1	I / T1+	I+II / T1+T2	II / T2	III / T3
230 / 400 V	3-phase	TN-S/TT				✓	
						✓	
						✓	
						✓	
						✓	
			✓				✓
	1-phase	TN-S/TT				✓	
						✓	
						✓	
						✓	
						✓	
							✓

## in a 230/400 V system, standard applications

Surge protective device	Order No.	Page
FLT-SEC-P-T1-3S-350/25-FM	2905421	22
FLT-SEC-H-T1-3C-264/25-FM + FLT-SEC-P-T1-N/PE-350/100-FM	2905871 + 2905472	20
FLT-SEC-T1+T2-3S-350/25-FM	2905470	25
VAL-SEC-T2-3S-350-FM	2905340	28
PLT-SEC-T3-3S-230-FM	2905230	30
FLT-SEC-P-T1-3C-350/25-FM	2905419	22
FLT-SEC-H-T1-3C-F-264/25-FM	2905871	20
FLT-SEC-T1+T2-3C-350/25-FM	2905469	25
VAL-SEC-T2-3C-350-FM	2905339	28
FLT-SEC-P-T1-2S-350/25-FM	2905418	23
2 x FLT-SEC-H-T1-1C-264/25-FM + FLT-SEC-P-T1-N/PE-350/100-FM	2801615 + 2905472	20
FLT-SEC-T1+T2-2S-350/25-FM	2905468	26
VAL-SEC-T2-2S-350-FM	2905338	29
FLT-SEC-P-T1-2C-350/25-FM	2905416	23
2 x FLT-SEC-H-T1-1C-264/25-FM	2801615	20
FLT-SEC-T1+T2-2C-350/25-FM	2905467	27
VAL-SEC-T2-2C-350-FM	2905337	29
FLT-SEC-P-T1-1S-350/25-FM	2905415	23
FLT-SEC-H-T1-1C-264/25-FM + FLT-SEC-P-T1-N/PE-350/100-FM	2801615 + 2905472	20
FLT-SEC-T1+T2-1S-350/25-FM	2905466	27
VAL-SEC-T2-1S-350-FM	2905333	29
PLT-SEC-T3-230-FM	2905229	31
FLT-SEC-P-T1-1C-350/25-FM	2905414	24
FLT-SEC-H-T1-1C-264/25-FM	2801615	20
FLT-SEC-T1+T2-1C-350/25-FM	2905465	27

## in a 230/400 V system, special installation conditions

Surge protective device	Order No.	Page
VAL-CP-RCD-3S/40/0.03 With RCD (30 mA rated residual current)	2808002	51
VAL-CP-RCD-3S/40/0.3SEL With RCD (300 mA rated residual current)	2808001	51
VAL-CP-MCB-3S-350/40/FM With MCB	2882750	53
VAL-CP-MOSO 60-3S-FM With MCB for 60 mm rail system	2804403	52
VAL-MS 350VF/3+1-FM Free of leakage current	2885632	42
GEB-SET-T1/T2 TAE/TV-SAT Set solution for building installation	2801022	39
VAL-CP-MCB-3C-350/40/FM With MCB	2882776	53
VAL-CP-MOSO 60-3C-FM With MSB for 60 mm rail system	2804416	52
VAL-CP-MCB-1S-350/40/FM With MCB	2882763	53
VAL-MS 350 VF/1+1-FM Free of leakage current	2902577	43
MNT-1 D Attachment plug	2882200	56
BT-1S-230AC/A Universal mounting (audible)	2803409	55
BT-1S-230AC/O Universal mounting (optical)	2800625	55

# Surge protection and interference suppression filters

## Selection guide for the power supply

### Surge protection for the power supply, other network types

The selection matrix makes it easy to select suitable surge protection for the desired application. Further application recommendations, in particular for DC applications, on request.

#### Network type

TN-S/TT  
3-phase



TN-C  
3-phase



TN-S/TT  
2-phase



TN-C  
2-phase



TN-S/TT  
1-phase



TN-C  
1-phase



TN-S/TT  
End devices



IT  
3-phase



#### Note

Products bearing this stamp (plug elements) can be tested with the CHECKMASTER.

Network type			IEC test classification/EN type					
			I / T1	I / T1+II	I+II / T1+T2	II / T2	III / T3	
120 V	3-phase	TN-S/TT	✓				✓	
		TN-C	✓				✓	
	2-phase	TN-S/TT				✓		
		TN-C				✓		
	1-phase	TN-S/TT	✓			✓		
		TN-C	✓					✓
400 V	3-phase	IT Without neutral conductor	✓				✓	
400 / 690 V	3-phase	TN	✓				✓	
554 / 960 V	3-phase	TN	✓				✓	
500 ... 690 V	3-phase	IT Without neutral conductor	✓				✓	
24 V	End devices	TN-S/TT	✓				✓	
		IT						✓
600 V	DC PV applications	TN-S/TT	✓					
		IT					✓	
1000 V	DC PV applications	TN-S/TT	✓				✓	
		IT						✓
		TN-S/TT	✓					
		TN-C	✓					
		IT	✓					



Surge protective device	Order No.	Page
VAL-MS-T1/T2-175/12.5/3+1-FM	2800670	36
VAL-SEC-T2-3S-175-FM	2905354	28
VAL-MS-T1/T2 175/12.5/3+0-FM	2800672	36
VAL-SEC-T2-3C-175-FM	2905353	28
VAL-SEC-T2-2S-175-FM	2905351	29
VAL-SEC-T2-2C-175-FM	2905350	29
VAL-MS-T1/T2-175/12.5/1+1-FM	2800674	37
VAL-SEC-T2-1S-175-FM	2905348	29
PLT-SEC-T3-120-FM	2905228	31
VAL-MS-T1/T2-175/12.5/1+0-FM	2801044	37
VAL-MS-120-ST + VAL-MS BE/FM	2807586 + 2817738	45
FLT-SEC-P-T1-3C-440/25-FM	2905988	21
VAL-MS 580/3+0-FM	2920447	41
FLT-SEC-P-T1-3C-440/25-FM	2905988	21
VAL-MS 580/3+0-FM	2920447	41
PWT 100-800/AC-FM	2800419	35
VAL-MS 750/30/3+0-FM	2920272	48
PWT 100-800/AC-FM	2800419	35
VAL-MS 750/30/3+0-FM	2920272	48
VAL-MS-T1/T2 48/12.5/1+0-FM	2801240	38
VAL-MS 60/FM	2868033	44
PLT-SEC-T3-24-FM	2905223	31
VAL-MS-T1/T2 600DC-PV/2+V-FM	2801164	58
VAL-MS 600DC-PV/2+V-FM	2800641	58
VAL-MS-T1/T2 1000DC-PV/2+V-FM	2801161	58
VAL-MS 1000DC-PV/2+V-FM	2800627	58
PV-SET 1ST/1000DC/1MPP-SPD-SC For one MPP tracker	2801529	60
PV-SET 2ST/1000DC/2MPP-SPD-SC For two MPP trackers	2801317	60
PV-SET 3ST/1000DC/3MPP-SPD-SC For three MPP trackers	2801531	60
PV-SET 2ST/1000DC-SPD-DC-SC For two solar strings incl. disconnecter	2801318	60



### Safe Energy Control (SEC) technology

The new surge protective devices with Safe Energy Control technology represent an easy-to-install product range which combines maximum performance and superior durability. Electrical equipment is reliably protected and maintenance costs are reduced. Installation of arresters with SEC technology is easy, cost-effective, and space-saving.

### Isolated and durable

A consistent surge protection concept requires a powerful type 1 lightning arrester. Conventional type 1 spark gaps burden the installation with high line follow currents, which can also cause the surge protection upstream to be triggered. The lightning arresters in the SEC range are the first of their kind to feature spark gap technology with no line follow current. The avoidance of line follow currents benefits the entire installation. This not only applies to the protected equipment, but the entire supply, including the arrester. Maximum system availability is achieved because the fuse protection upstream is not triggered.

### Solution without backup fuse for every application

The powerful lightning arresters and surge protective devices with Safe Energy Control technology provide a solution without separate arrester backup fuse for all common applications. For applications where the protection of the installation is the top priority, type 1 and type 2 arresters can be used for main fuse ratings of 315 A gG without separate overcurrent protection. For applications beyond this scope, products are available with integrated surge-proof fuse, such as the FLT-SEC-HYBRID. The type 3 protective devices in the PLT range can be operated in branch wiring without any kind of backup fuse, which is also thanks to the integrated surge-proof fuses.

### Compact and consistent plug-in design

With the FLT-SEC-PLUS-440, the SEC range offers the most compact type 1 spark gap for this nominal voltage, with the VAL-SEC the narrowest type 2 arrester, and with the FLT-SEC-T1+T2 the only directly coordinated combination of type 1 spark gap and type 2 varistor arrester in a confined space. All products in the SEC range have a plug-in design. Maintenance work is therefore made much easier.

### Everything in the green – we're betting that you won't see red for five years

With the low-wear surge protective devices in the SEC range, you won't have to think about replacing wear parts for at least five years. Thanks to the SEC technology, the high-quality components are particularly durable. However, should the status indicator signal the need for replacement within the first five years following purchase, you will receive a free replacement device.

**i** Your web code: **#0143**



### New spark gaps

The newly developed spark gaps in the type 1 arresters are isolated and extremely powerful thanks to the use of technology with no line follow current. This increases the durability of the components in your system.



### Type 1 lightning arrester with integrated arrester backup fuse

The FLT-SEC-HYBRID... combines surge protection and a backup fuse in a single connector. It is no longer necessary to install a separate arrester backup fuse. This saves space and reduces installation costs.



### The power package

Maximum discharge capacity in an extremely compact design. And all for continuous voltages up to 440 V. The ideal type 1 lightning arrester for use in industry and wind power plants.



### Lightning current and surge protection

Reliable protection and minimal installation effort thanks to the narrowest, coordinated combination of real type 1 lightning arresters and type 2 surge protective devices.



### Ultra narrow

With an overall width of just 12.5 mm per channel, the type 2 surge protective devices provide outstanding protection in a minimum amount of space - they can be used up to 315 A in the branch without a backup fuse.



### Powerful type 3 device protection

Integrated surge-proof fuses eliminate the need for a separate fuse in the branch. This saves space and simplifies planning.

# Surge protection and interference suppression filters

## Surge protection for the power supply with Safe Energy Control

### Type 1 lightning arrester FLASHTRAB SEC HYBRID

- Integrated combination of spark gap without line follow current and surge-proof fuse
- Can be used without separate backup fuse thanks to integrated overcurrent protection
- Free of leakage current, suitable for use in the pre-meter area
- Can be inserted with innovative push-pull locking mechanism
- Low voltage protection level of 1.5 kV
- Optical, mechanical status indicator
- With floating remote indication contact



4-conductor system; L1, L2, L3, PEN

new



2-conductor system; L, PEN

new

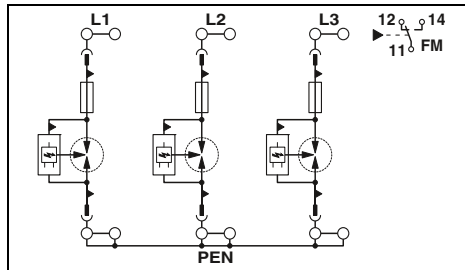

Technical data

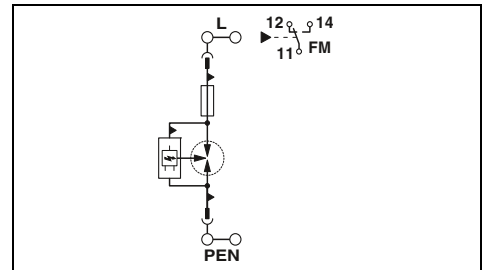

Technical data

<b>Electrical data</b>	
IEC test classification	I / II, T1 / T2
Nominal voltage $U_N$	240/415 V AC (TN-C)
Maximum continuous operating voltage $U_C$	L-PEN 264 V AC
Impulse discharge curr. $I_{imp}$ (10/350) $\mu$ s	L-PEN 12.5 As
Charge	L-PEN 160 kJ/ $\Omega$
Specific energy	L-PEN 25 kA
Peak value	L-PEN 25 kA
Nominal discharge current $I_n$ (8/20) $\mu$ s	L-PEN 50 kA
Max. discharge current $I_{max}$ (8/20) $\mu$ s	L-PEN $\leq 1.5$ kV
Voltage protection level $U_p$	L-PEN 50 kA
Follow current interrupt rating $I_{fi}$	L-PEN 50 kA
Short-circuit current rating $I_{SCCR}$	-
Max. backup fuse with branch wiring	-
Response time $t_d$	L-PEN $\leq 100$ ns
<b>General data</b>	
Dimensions W / H / D	106.8 mm / 167 mm / 74.5 mm
Connection data solid / stranded / AWG (IEC) / AWG (UL)	2.5 ... 35 mm <sup>2</sup> / 2.5 ... 35 mm <sup>2</sup> / 13 - 2 / -
Temperature range	-40°C ... 80°C
Inflammability class in acc. with UL 94	V-0
Test standards	IEC 61643-11 / EN 61643-11
Remote indication contact	PDT contact
Connection data solid / stranded / AWG (IEC) / AWG (UL)	0.14 ... 1.5 mm <sup>2</sup> / 0.14 ... 1.5 mm <sup>2</sup> / 28 - 16 / -
Max. operating voltage	250 V AC / 125 V DC (200 mA DC)
Max. operating current	1 A AC / 1 A DC (30 V DC)

<b>Technical data</b>	
I / II, T1 / T2	I / II, T1 / T2
240/415 V AC (TN-C)	240 V AC (TN-C) / 240 V AC (TT)
L-PEN 264 V AC	264 V AC
L-PEN 12.5 As	12.5 As
L-PEN 160 kJ/ $\Omega$	160 kJ/ $\Omega$
L-PEN 25 kA	25 kA
L-PEN 25 kA	25 kA
L-PEN 50 kA	50 kA
L-PEN $\leq 1.5$ kV	$\leq 1.5$ kV
L-PEN 50 kA	50 kA
L-PEN 50 kA	50 kA
-	-
L-PEN $\leq 100$ ns	$\leq 100$ ns
<b>General data</b>	
Dimensions W / H / D	35.5 mm / 167 mm / 74.5 mm
Connection data solid / stranded / AWG (IEC) / AWG (UL)	2.5 ... 35 mm <sup>2</sup> / 2.5 ... 35 mm <sup>2</sup> / 13 - 2 / -
Temperature range	-40°C ... 80°C
Inflammability class in acc. with UL 94	V-0
Test standards	IEC 61643-11 / EN 61643-11
Remote indication contact	PDT contact
Connection data solid / stranded / AWG (IEC) / AWG (UL)	0.14 ... 1.5 mm <sup>2</sup> / 0.14 ... 1.5 mm <sup>2</sup> / 28 - 16 / -
Max. operating voltage	250 V AC / 125 V DC (200 mA DC)
Max. operating current	1 A AC / 1 A DC (30 V DC)

<b>Ordering data</b>	
<b>Description</b>	<b>Type</b>
<b>FLASHTRAB</b>	<b>FLT-SEC-H-T1-3C-264/25-FM</b>
	<b>Order No.</b> 2905871
	<b>Pcs. / Pkt.</b> 1
<b>Accessories</b>	
<b>Replacement plug</b>	<b>FLT-SEC-H-T1-264/25-P</b>
L-N / L-PEN	<b>Order No.</b> 2905968
	<b>Pcs. / Pkt.</b> 1

<b>Ordering data</b>	
<b>Description</b>	<b>Type</b>
<b>FLASHTRAB</b>	<b>FLT-SEC-H-T1-1C-264/25-FM</b>
	<b>Order No.</b> 2801615
	<b>Pcs. / Pkt.</b> 1
<b>Accessories</b>	
<b>Replacement plug</b>	<b>FLT-SEC-H-T1-264/25-P</b>
L-N / L-PEN	<b>Order No.</b> 2905968
	<b>Pcs. / Pkt.</b> 1

### Type 1 lightning arrester FLASHTRAB SEC PLUS 440

- Spark gap has no line follow current
- Suitable for use in the pre-meter area
- Satisfies TOV requirements for use in IT systems
- Plug-in
- Low voltage protection level of 2.5 kV
- Optical, mechanical status indicator
- With floating remote indication contact
- Plugs can be checked with CHECKMASTER



4-conductor system, L1, L2, L3, PE(N)



2-conductor system, L, PE(N)

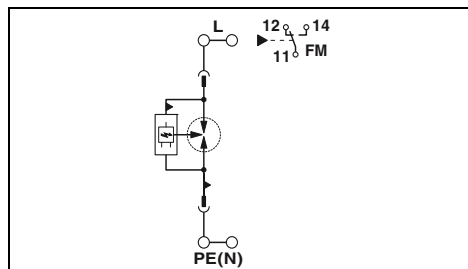
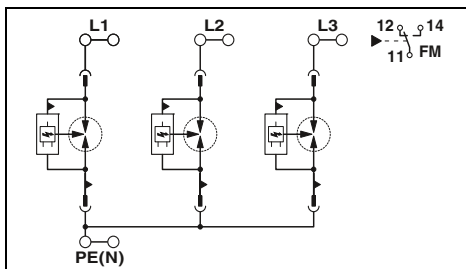

#### Technical data

Electrical data		
IEC test classification		I / II, T1 / T2
Nominal voltage $U_N$		400/690 V AC (TN-C) / 400 V AC (IT)
Maximum continuous operating voltage $U_c$	L-PEN	440 V AC
Impulse discharge curr. $I_{imp}$ (10/350) $\mu$ s	L-PEN	12.5 As
Charge	L-PEN	160 kJ/ $\Omega$
Specific energy	L-PEN	25 kA
Peak value	L-PEN	25 kA
Nominal discharge current $I_n$ (8/20) $\mu$ s	L-PEN	50 kA
Max. discharge current $I_{max}$ (8/20) $\mu$ s	L-PEN	$\leq 2.5$ kV
Voltage protection level $U_p$	L-PEN	50 kA
Follow current interrupt rating $I_{fi}$	L-PEN	50 kA
Short-circuit current rating $I_{SCCR}$		400 A AC (gG)
Max. backup fuse with branch wiring		
Response time $t_A$	L-PEN	$\leq 100$ ns
General data		
Dimensions W / H / D		106.8 mm / 95.2 mm / 74.5 mm
Connection data solid / stranded / AWG (IEC) / AWG (UL)		2.5 ... 35 mm <sup>2</sup> / 2.5 ... 35 mm <sup>2</sup> / 13 - 2 / -
Temperature range		-40°C ... 80°C
Inflammability class in acc. with UL 94		V-0
Test standards		IEC 61643-11 / EN 61643-11
Remote indication contact		PDT contact
Connection data solid / stranded / AWG (IEC) / AWG (UL)		0.14 ... 1.5 mm <sup>2</sup> / 0.14 ... 1.5 mm <sup>2</sup> / 28 - 16 / -
Max. operating voltage		250 V AC / 125 V DC (200 mA DC)
Max. operating current		1 A AC / 1 A DC (30 V DC)

#### Ordering data

Description	Type	Order No.	Pcs. / Pkt.
FLASHTRAB	FLT-SEC-P-T1-3C-440/25-FM	2905988	1

#### Accessories

Replacement plug	Type	Order No.	Pcs. / Pkt.
L-N / L-PEN	FLT-SEC-P-T1-440/25-P	2905989	1

#### Technical data

Electrical data		
IEC test classification		I / II, T1 / T2
Nominal voltage $U_N$		400 V AC (TN) / 400 V AC (IT)
Maximum continuous operating voltage $U_c$		440 V AC
Impulse discharge curr. $I_{imp}$ (10/350) $\mu$ s		12.5 As
Charge		160 kJ/ $\Omega$
Specific energy		25 kA
Peak value		25 kA
Nominal discharge current $I_n$ (8/20) $\mu$ s		50 kA
Max. discharge current $I_{max}$ (8/20) $\mu$ s		$\leq 2.5$ kV
Voltage protection level $U_p$		50 kA
Follow current interrupt rating $I_{fi}$		50 kA
Short-circuit current rating $I_{SCCR}$		400 A AC (gG)
Max. backup fuse with branch wiring		
Response time $t_A$		$\leq 100$ ns
General data		
Dimensions W / H / D		35.6 mm / 95.2 mm / 74.5 mm
Connection data solid / stranded / AWG (IEC) / AWG (UL)		2.5 ... 35 mm <sup>2</sup> / 2.5 ... 35 mm <sup>2</sup> / 13 - 2 / -
Temperature range		-40°C ... 80°C
Inflammability class in acc. with UL 94		V-0
Test standards		IEC 61643-11 / EN 61643-11
Remote indication contact		PDT contact
Connection data solid / stranded / AWG (IEC) / AWG (UL)		0.14 ... 1.5 mm <sup>2</sup> / 0.14 ... 1.5 mm <sup>2</sup> / 28 - 16 / -
Max. operating voltage		250 V AC / 125 V DC (200 mA DC)
Max. operating current		1 A AC / 1 A DC (30 V DC)

#### Ordering data

Description	Type	Order No.	Pcs. / Pkt.
FLASHTRAB	FLT-SEC-P-T1-1C-440/25-FM	2905987	1

#### Accessories

Replacement plug	Type	Order No.	Pcs. / Pkt.
L-N / L-PEN	FLT-SEC-P-T1-440/25-P	2905989	1

# Surge protection and interference suppression filters

## Surge protection for the power supply with Safe Energy Control

### Type 1 lightning arrester FLASHTRAB SEC PLUS

- Spark gap has no line follow current
- Free of leakage current, suitable for use in the pre-meter area
- Plug-in
- High continuous voltage of 350 V AC for 230/400 V AC networks with high voltage fluctuations
- Low voltage protection level of 1.5 kV
- Optical, mechanical status indicator
- With floating remote indication contact
- Plugs can be checked with CHECKMASTER



5-conductor system; L1, L2, L3, N, PE



4-conductor system; L1, L2, L3, PEN

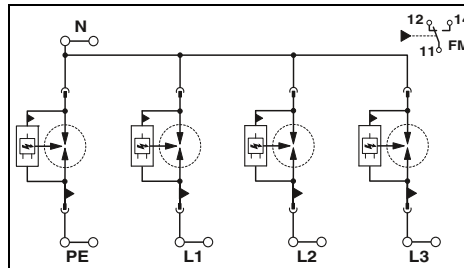

#### Technical data

Electrical data		
IEC test classification		I / II, T1 / T2
Nominal voltage $U_N$		240/415 V AC (TN-S) / 240/415 V AC (TT)
Maximum continuous operating voltage $U_c$	L-N / N-PE / L-PEN	350 V AC / 350 V AC / -
Impulse discharge curr. $I_{imp}$ (10/350) $\mu$ s	L-N / N-PE / L-PEN	12.5 As / 50 As / -
Charge	L-N / N-PE / L-PEN	160 kJ/ $\Omega$ / 2500 kJ/ $\Omega$ / -
Specific energy	L-N / N-PE / L-PEN	25 kA / 100 kA / -
Peak value	L-N / N-PE / L-PEN	25 kA / 100 kA / -
Nominal discharge current $I_n$ (8/20) $\mu$ s	L-N / N-PE / L-PEN	25 kA / 100 kA / -
Max. discharge current $I_{max}$ (8/20) $\mu$ s	L-N / N-PE / L-PEN	50 kA / - / -
Voltage protection level $U_p$	L-N / N-PE / L-PEN	$\leq 1.5$ kV / $\leq 1.5$ kV / -
Follow current interrupt rating $I_{fi}$	L-N / N-PE / L-PEN	50 kA / 100 A / -
Short-circuit current rating $I_{SCCR}$		50 kA
Response time $t_A$	L-N / N-PE / L-PEN	$\leq 100$ ns / $\leq 100$ ns / -
General data		
Dimensions W / H / D		142.4 mm / 95.2 mm / 74.5 mm
Connection data solid / stranded / AWG (IEC) / AWG (UL)		2.5 ... 35 mm <sup>2</sup> / 2.5 ... 25 mm <sup>2</sup> / 13 - 2 / 12 - 2
Temperature range		-40°C ... 80°C
Inflammability class in acc. with UL 94		V-0
Test standards		IEC 61643-11 / EN 61643-11
Remote indication contact		PDT contact
Connection data solid / stranded / AWG (IEC) / AWG (UL)		0.14 ... 1.5 mm <sup>2</sup> / 0.14 ... 1.5 mm <sup>2</sup> / 28 - 16 / 30 - 14
Max. operating voltage		250 V AC / 125 V DC (200 mA DC)
Max. operating current		1 A AC / 1 A DC (30 V DC)

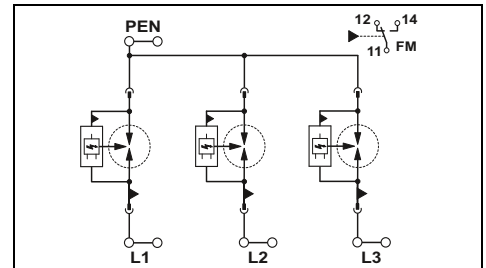

#### Technical data

Electrical data		
IEC test classification		I / II, T1 / T2
Nominal voltage $U_N$		240/415 V AC (TN-C)
Maximum continuous operating voltage $U_c$		- / - / 350 V AC
Impulse discharge curr. $I_{imp}$ (10/350) $\mu$ s		- / - / 12.5 As
Charge		- / - / 160 kJ/ $\Omega$
Specific energy		- / - / 25 kA
Peak value		- / - / 25 kA
Nominal discharge current $I_n$ (8/20) $\mu$ s		- / - / 25 kA
Max. discharge current $I_{max}$ (8/20) $\mu$ s		- / - / 50 kA
Voltage protection level $U_p$		- / - / $\leq 1.5$ kV
Follow current interrupt rating $I_{fi}$		- / - / 50 kA
Short-circuit current rating $I_{SCCR}$		50 kA
Response time $t_A$		- / - / $\leq 100$ ns
General data		
Dimensions W / H / D		106.8 mm / 95.2 mm / 74.5 mm
Connection data solid / stranded / AWG (IEC) / AWG (UL)		2.5 ... 35 mm <sup>2</sup> / 2.5 ... 25 mm <sup>2</sup> / 13 - 2 / 12 - 2
Temperature range		-40°C ... 80°C
Inflammability class in acc. with UL 94		V-0
Test standards		IEC 61643-11 / EN 61643-11
Remote indication contact		PDT contact
Connection data solid / stranded / AWG (IEC) / AWG (UL)		0.14 ... 1.5 mm <sup>2</sup> / 0.14 ... 1.5 mm <sup>2</sup> / 28 - 16 / 30 - 14
Max. operating voltage		250 V AC / 125 V DC (200 mA DC)
Max. operating current		1 A AC / 1 A DC (30 V DC)

#### Ordering data

Description	Type	Order No.	Pcs. / Pkt.
FLASHTRAB	FLT-SEC-P-T1-3S-350/25-FM	2905421	1

#### Accessories

Replacement plug	L-N / L-PEN	FLT-SEC-P-T1-350/25-P	2905422	1
	N-PE	FLT-SEC-P-T1-N/PE-350/100-P	2905473	1

#### Ordering data

Description	Type	Order No.	Pcs. / Pkt.
FLASHTRAB	FLT-SEC-P-T1-3C-350/25-FM	2905419	1

#### Accessories

Replacement plug		FLT-SEC-P-T1-350/25-P	2905422	1
------------------	--	-----------------------	---------	---



new



4-conductor system; L1, L2, N, PE



new



3-conductor system; L1, L2, PEN



new



3-conductor system; L, N, PE

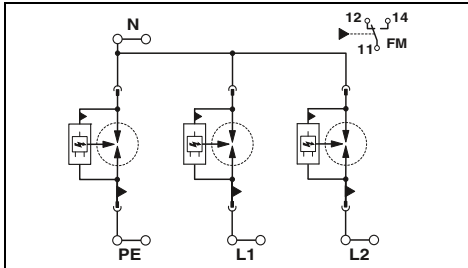

### Technical data

I / II, T1 / T2  
240/415 V AC (TN-S) / 240/415 V AC (TT)

350 V AC / 350 V AC / -

12.5 As / 50 As / -  
160 kJ/Ω / 2500 kJ/Ω / -  
25 kA / 100 kA / -

25 kA / 100 kA / -

50 kA / - / -

≤ 1.5 kV / ≤ 1.5 kV / -

50 kA / 100 A / -  
50 kA

≤ 100 ns / ≤ 100 ns / -

106.8 mm / 95.2 mm / 74.5 mm  
2.5 ... 35 mm<sup>2</sup> / 2.5 ... 25 mm<sup>2</sup> / 13 - 2 / 12 - 2

-40°C ... 80°C  
V-0  
IEC 61643-11 / EN 61643-11  
PDT contact  
0.14 ... 1.5 mm<sup>2</sup> / 0.14 ... 1.5 mm<sup>2</sup> / 28 - 16 / 30 - 14

250 V AC / 125 V DC (200 mA DC)  
1 A AC / 1 A DC (30 V DC)

### Ordering data

Type	Order No.	Pcs. / Pkt.
FLT-SEC-P-T1-2S-350/25-FM	2905418	1

### Accessories

FLT-SEC-P-T1-350/25-P	2905422	1
FLT-SEC-P-T1-N/PE-350/100-P	2905473	1

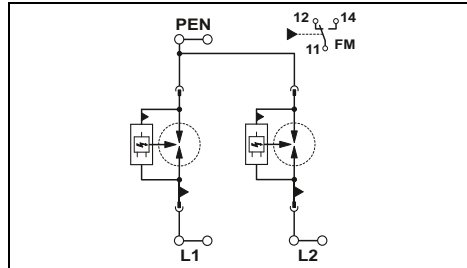

### Technical data

I / II, T1 / T2  
240/415 V AC (TN-C)

- / - / 350 V AC

- / - / 12.5 As  
- / - / 160 kJ/Ω  
- / - / 25 kA

- / - / 25 kA

- / - / 50 kA

- / - / ≤ 1.5 kV

- / - / 50 kA  
50 kA

- / - / ≤ 100 ns

71.2 mm / 95.2 mm / 74.5 mm  
2.5 ... 35 mm<sup>2</sup> / 2.5 ... 25 mm<sup>2</sup> / 13 - 2 / 12 - 2

-40°C ... 80°C  
V-0  
IEC 61643-11 / EN 61643-11  
PDT contact  
0.14 ... 1.5 mm<sup>2</sup> / 0.14 ... 1.5 mm<sup>2</sup> / 28 - 16 / 30 - 14

250 V AC / 125 V DC (200 mA DC)  
1 A AC / 1 A DC (30 V DC)

### Ordering data

Type	Order No.	Pcs. / Pkt.
FLT-SEC-P-T1-2C-350/25-FM	2905416	1

### Accessories

FLT-SEC-P-T1-350/25-P	2905422	1
-----------------------	---------	---

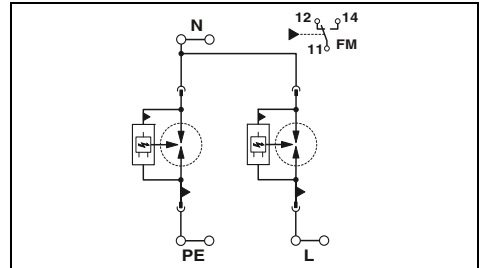

### Technical data

I / II, T1 / T2  
240 V AC (TN-S) / 240 V AC (TT)

350 V AC / 350 V AC / -

12.5 As / 50 As / -  
160 kJ/Ω / 2500 kJ/Ω / -  
25 kA / 100 kA / -

25 kA / 100 kA / -

50 kA / - / -

≤ 1.5 kV / ≤ 1.5 kV / -

50 kA / 100 A / -  
50 kA

≤ 100 ns / ≤ 100 ns / -

71.2 mm / 95.2 mm / 74.5 mm  
2.5 ... 35 mm<sup>2</sup> / 2.5 ... 25 mm<sup>2</sup> / 13 - 2 / 12 - 2

-40°C ... 80°C  
V-0  
IEC 61643-11 / EN 61643-11  
PDT contact  
0.14 ... 1.5 mm<sup>2</sup> / 0.14 ... 1.5 mm<sup>2</sup> / 28 - 16 / 30 - 14

250 V AC / 125 V DC (200 mA DC)  
1 A AC / 1 A DC (30 V DC)

### Ordering data

Type	Order No.	Pcs. / Pkt.
FLT-SEC-P-T1-1S-350/25-FM	2905415	1

### Accessories

FLT-SEC-P-T1-350/25-P	2905422	1
FLT-SEC-P-T1-N/PE-350/100-P	2905473	1

# Surge protection and interference suppression filters

## Surge protection for the power supply with Safe Energy Control

### Type 1 lightning arrester FLASHTRAB SEC PLUS

- Spark gap has no line follow current
- Free of leakage current, suitable for use in the pre-meter area
- Plug-in
- High continuous voltage of 350 V AC for 230/400 V AC networks with high voltage fluctuations
- Low voltage protection level of 1.5 kV
- Optical, mechanical status indicator
- With floating remote indication contact
- Plugs can be checked with CHECKMASTER



2-conductor system; L, PEN



N-PE spark gap

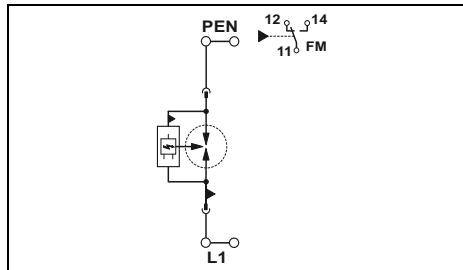

#### Technical data

Electrical data		
IEC test classification		I / II, T1 / T2
Nominal voltage $U_N$		240 V AC (TN-C) / 240 V AC (TT)
Maximum continuous operating voltage $U_c$	L-N / N-PE / L-PEN	- / - / 350 V AC
Impulse discharge curr. $I_{imp}$ (10/350) $\mu$ s	L-N / N-PE / L-PEN	- / - / 12.5 As
Charge	L-N / N-PE / L-PEN	- / - / 160 kJ/ $\Omega$
Specific energy	L-N / N-PE / L-PEN	- / - / 25 kA
Peak value	L-N / N-PE / L-PEN	- / - / 25 kA
Nominal discharge current $I_n$ (8/20) $\mu$ s	L-N / N-PE / L-PEN	- / - / 25 kA
Max. discharge current $I_{max}$ (8/20) $\mu$ s	L-N / N-PE / L-PEN	- / - / 50 kA
Voltage protection level $U_p$	L-N / N-PE / L-PEN	- / - / $\leq 1.5$ kV
Follow current interrupt rating $I_{fi}$	L-N / N-PE / L-PEN	- / - / 50 kA
Short-circuit current rating $I_{SCCR}$		50 kA
Max. backup fuse with branch wiring		315 A AC (gG)
Response time $t_d$	L-N / N-PE / L-PEN	- / - / $\leq 100$ ns
General data		
Dimensions W / H / D		35.6 mm / 95.2 mm / 74.5 mm
Connection data solid / stranded / AWG (IEC) / AWG (UL)		2.5 ... 35 mm <sup>2</sup> / 2.5 ... 25 mm <sup>2</sup> / 13 - 2 / 12 - 2
Temperature range		-40°C ... 80°C
Inflammability class in acc. with UL 94		V-0
Test standards		IEC 61643-11 / EN 61643-11
Remote indication contact		PDT contact
Connection data solid / stranded / AWG (IEC) / AWG (UL)		0.14 ... 1.5 mm <sup>2</sup> / 0.14 ... 1.5 mm <sup>2</sup> / 28 - 16 / 30 - 14
Max. operating voltage		250 V AC / 125 V DC (200 mA DC)
Max. operating current		1 A AC / 1 A DC (30 V DC)

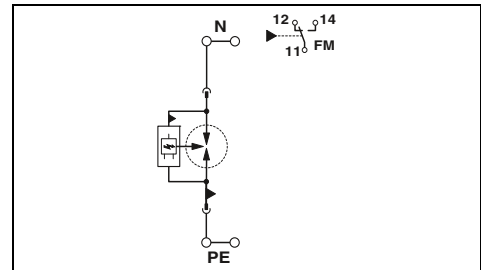

#### Technical data

Electrical data		
IEC test classification		I / II, T1 / T2
Nominal voltage $U_N$		240 V AC (TN - only N-PE) / 240 V AC (TT - only N-PE)
Maximum continuous operating voltage $U_c$		- / 350 V AC / -
Impulse discharge curr. $I_{imp}$ (10/350) $\mu$ s		- / 50 As / -
Charge		- / 2500 kJ/ $\Omega$ / -
Specific energy		- / 100 kA / -
Peak value		- / 100 kA / -
Nominal discharge current $I_n$ (8/20) $\mu$ s		- / 100 kA / -
Max. discharge current $I_{max}$ (8/20) $\mu$ s		- / - / -
Voltage protection level $U_p$		- / $\leq 1.5$ kV / -
Follow current interrupt rating $I_{fi}$		- / 100 A (350 V AC) / -
Short-circuit current rating $I_{SCCR}$		-
Max. backup fuse with branch wiring		-
Response time $t_d$		- / $\leq 100$ ns / -
General data		
Dimensions W / H / D		35.6 mm / 95.2 mm / 74.5 mm
Connection data solid / stranded / AWG (IEC) / AWG (UL)		2.5 ... 35 mm <sup>2</sup> / 2.5 ... 25 mm <sup>2</sup> / 13 - 2 / 12 - 2
Temperature range		-40°C ... 80°C
Inflammability class in acc. with UL 94		V-0
Test standards		IEC 61643-11 / EN 61643-11
Remote indication contact		PDT contact
Connection data solid / stranded / AWG (IEC) / AWG (UL)		0.14 ... 1.5 mm <sup>2</sup> / 0.14 ... 1.5 mm <sup>2</sup> / 28 - 16 / 30 - 14
Max. operating voltage		250 V AC / 125 V DC (200 mA DC)
Max. operating current		1 A AC / 1 A DC (30 V DC)

#### Ordering data

Description	Type	Order No.	Pcs. / Pkt.
FLASHTRAB	FLT-SEC-P-T1-1C-350/25-FM	2905414	1

#### Accessories

Replacement plug	L-N / L-PEN N-PE	FLT-SEC-P-T1-350/25-P	2905422	1
------------------	---------------------	-----------------------	---------	---

#### Ordering data

Description	Type	Order No.	Pcs. / Pkt.
	FLT-SEC-P-T1-N/PE-350/100-FM	2905472	1

#### Accessories

	L-N / L-PEN N-PE	FLT-SEC-P-T1-N/PE-350/100-P	2905473	1
--	---------------------	-----------------------------	---------	---



### Type 1 + 2 lightning and surge arrester combination

#### FLASHTRAB SEC T1+T2

- Directly coordinated combination of type 1 spark gap without line follow current and type 2 varistor arrester
- Particularly suitable for maximum protection of sensitive devices in harsh environments
- Plug-in
- High continuous voltage of 350 V AC for 230/400 V AC networks with high voltage fluctuations
- Low voltage protection level of 1.5 kV
- Optical, mechanical status indicator
- With floating remote indication contact
- Plugs can be checked with CHECKMASTER



5-conductor system; L1, L2, L3, N, PE



4-conductor system; L1, L2, L3, PEN

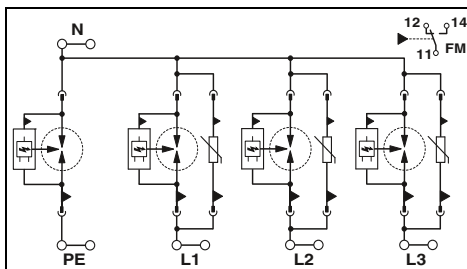

#### Technical data

Electrical data		I + II, T1 + T2
IEC test classification		240/415 V AC (TN-S) / 240/415 V AC (TT)
Nominal voltage $U_N$		
Maximum continuous operating voltage $U_c$	L-N / N-PE / L-PEN	350 V AC / 350 V AC / -
Impulse discharge curr. $I_{imp}$ (10/350) $\mu$ s	L-N / N-PE / L-PEN	12.5 As / 50 As / -
Charge	L-N / N-PE / L-PEN	160 kJ/ $\Omega$ / 2500 kJ/ $\Omega$ / -
Specific energy	L-N / N-PE / L-PEN	25 kA / 100 kA / -
Peak value	L-N / N-PE / L-PEN	
Nominal discharge current $I_n$ (8/20) $\mu$ s	L-N / N-PE / L-PEN	25 kA / 100 kA / -
Voltage protection level $U_p$	L-N / N-PE / L-PEN	$\leq 1.5$ kV / $\leq 1.5$ kV / -
Follow current interrupt rating $I_{fi}$	L-N / N-PE / L-PEN	25 kA (264 V AC) / 100 A (350 V AC) / -
Short-circuit current rating $I_{SCR}$		25 kA (264 V AC) / 3 kA (350 V AC)
Max. backup fuse with branch wiring		315 A AC (gG)
Response time $t_A$	L-N / N-PE / L-PEN	$\leq 25$ ns / $\leq 100$ ns / -

General data		
Dimensions W / H / D		142.4 mm / 95.2 mm / 74.5 mm
Connection data solid / stranded / AWG (IEC) / AWG (UL)		2.5 ... 35 mm <sup>2</sup> / 2.5 ... 25 mm <sup>2</sup> / 13 - 2 / 12 - 2
Temperature range		-40°C ... 80°C
Inflammability class in acc. with UL 94		V-0
Test standards		IEC 61643-11 / EN 61643-11
Remote indication contact		PDT contact
Connection data solid / stranded / AWG (IEC) / AWG (UL)		0.14 ... 1.5 mm <sup>2</sup> / 0.14 ... 1.5 mm <sup>2</sup> / 28 - 16 / 30 - 14
Max. operating voltage		250 V AC / 125 V DC (200 mA DC)
Max. operating current		1 A AC / 1 A DC (30 V DC)

#### Ordering data

Description	Type	Order No.	Pcs. / Pkt.
Type 1 + 2 lightning/surge arrester combination	FLT-SEC-T1+T2-3S-350/25-FM	2905470	1

#### Accessories

Replacement plug	Type	Order No.	Pcs. / Pkt.
L-N / L-PEN	FLT-SEC-T1-350/25-P	2905471	1
L-N / L-PEN	VAL-SEC-T2-350-P	2905346	1
N-PE	FLT-SEC-P-T1-N/PE-350/100-P	2905473	1

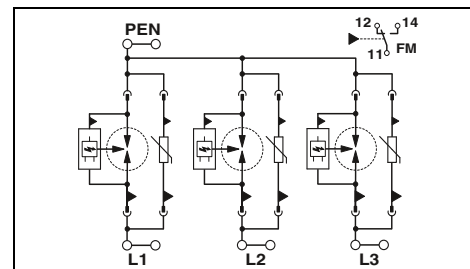

#### Technical data

Electrical data		I + II, T1 + T2
IEC test classification		240/415 V AC (TN-C)
Nominal voltage $U_N$		
Maximum continuous operating voltage $U_c$		- / - / 350 V AC
Impulse discharge curr. $I_{imp}$ (10/350) $\mu$ s		- / - / 12.5 As
Charge		- / - / 160 kJ/ $\Omega$
Specific energy		- / - / 25 kA
Peak value		
Nominal discharge current $I_n$ (8/20) $\mu$ s		- / - / 25 kA
Voltage protection level $U_p$		- / - / $\leq 1.5$ kV
Follow current interrupt rating $I_{fi}$		- / - / 25 kA (264 V AC)
Short-circuit current rating $I_{SCR}$		25 kA (264 V AC) / 3 kA (350 V AC)
Max. backup fuse with branch wiring		315 A AC (gG)
Response time $t_A$		- / - / $\leq 25$ ns

General data		
Dimensions W / H / D		106.8 mm / 95.2 mm / 74.5 mm
Connection data solid / stranded / AWG (IEC) / AWG (UL)		2.5 ... 35 mm <sup>2</sup> / 2.5 ... 25 mm <sup>2</sup> / 13 - 2 / 12 - 2
Temperature range		-40°C ... 80°C
Inflammability class in acc. with UL 94		V-0
Test standards		IEC 61643-11 / EN 61643-11
Remote indication contact		PDT contact
Connection data solid / stranded / AWG (IEC) / AWG (UL)		0.14 ... 1.5 mm <sup>2</sup> / 0.14 ... 1.5 mm <sup>2</sup> / 28 - 16 / 30 - 14
Max. operating voltage		250 V AC / 125 V DC (200 mA DC)
Max. operating current		1 A AC / 1 A DC (30 V DC)

#### Ordering data

Description	Type	Order No.	Pcs. / Pkt.
Type 1 + 2 lightning/surge arrester combination	FLT-SEC-T1+T2-3C-350/25-FM	2905469	1

#### Accessories

Replacement plug	Type	Order No.	Pcs. / Pkt.
L-N / L-PEN	FLT-SEC-T1-350/25-P	2905471	1
L-N / L-PEN	VAL-SEC-T2-350-P	2905346	1

# Surge protection and interference suppression filters

## Surge protection for the power supply with Safe Energy Control

### Type 1 + 2 lightning and surge arrester combination FLASHTRAB SEC T1+T2

- Directly coordinated combination of type 1 spark gap without line follow current and type 2 varistor arrester
- Particularly suitable for maximum protection of sensitive devices in harsh environments
- Plug-in
- High continuous voltage of 350 V AC for 230/400 V AC networks with high voltage fluctuations
- Low voltage protection level of 1.5 kV
- Optical, mechanical status indicator
- With floating remote indication contact
- Plugs can be checked with CHECKMASTER



4-conductor system; L1, L2, N, PE



3-conductor system; L1, L2, PEN

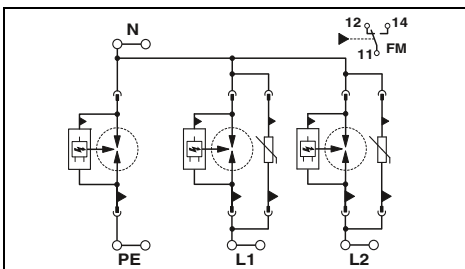

#### Technical data

Electrical data	
IEC test classification	
Nominal voltage $U_N$	L-N / L-PE / N-PE / L-PEN
Maximum continuous operating voltage $U_C$	L-N / L-PE / N-PE / L-PEN
Impulse discharge curr. $I_{imp}$ (10/350) $\mu$ s	L-N / N-PE / L-PEN
Charge	L-N / N-PE / L-PEN
Specific energy	L-N / N-PE / L-PEN
Peak value	L-N / N-PE / L-PEN
Nominal discharge current $I_n$ (8/20) $\mu$ s	L-N / N-PE / L-PEN
Voltage protection level $U_p$	L-N / N-PE / L-PEN
Follow current interrupt rating $I_{fi}$	L-N / N-PE / L-PEN
Short-circuit current rating $I_{SCCR}$	L-N / N-PE / L-PEN
Max. backup fuse with branch wiring	L-N / N-PE / L-PEN
Response time $t_A$	L-N / N-PE / L-PEN
General data	
Dimensions W / H / D	L-N / N-PE / L-PEN
Connection data solid / stranded / AWG (IEC) / AWG (UL)	L-N / N-PE / L-PEN
Temperature range	L-N / N-PE / L-PEN
Inflammability class in acc. with UL 94	L-N / N-PE / L-PEN
Test standards	L-N / N-PE / L-PEN
Remote indication contact	L-N / N-PE / L-PEN
Connection data solid / stranded / AWG (IEC) / AWG (UL)	L-N / N-PE / L-PEN
Max. operating voltage	L-N / N-PE / L-PEN
Max. operating current	L-N / N-PE / L-PEN

I + II, T1 + T2	240/415 V AC (TN-S) / 240/415 V AC (TT)
350 V AC / - / 350 V AC / -	
12.5 As / 50 As / -	
160 kJ/ $\Omega$ / 2500 kJ/ $\Omega$ / -	
25 kA / 100 kA / -	
25 kA / 100 kA / -	
$\leq 1.5$ kV / $\leq 1.5$ kV / -	
25 kA (264 V AC) / 100 A (350 V AC) / -	
25 kA (264 V AC) / 3 kA (350 V AC)	
315 A AC (gG)	
$\leq 25$ ns / $\leq 100$ ns / -	

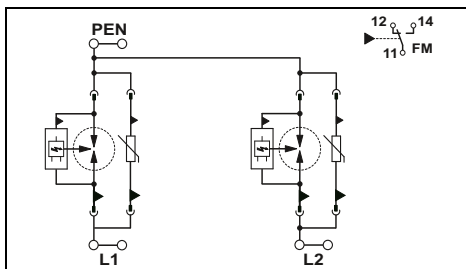

#### Technical data

I + II, T1 + T2	240/415 V AC (TN-C)
- / - / 350 V AC	
- / - / 12.5 As	
- / - / 160 kJ/ $\Omega$	
- / - / 25 kA	
- / - / 25 kA	
- / - / $\leq 1.5$ kV	
- / - / 25 kA (264 V AC)	
25 kA (264 V AC) / 3 kA (350 V AC)	
315 A AC (gG)	
- / - / $\leq 25$ ns	
General data	
Dimensions W / H / D	- / - / 71.2 mm / 95.2 mm / 74.5 mm
Connection data solid / stranded / AWG (IEC) / AWG (UL)	2.5 ... 35 mm <sup>2</sup> / 2.5 ... 25 mm <sup>2</sup> / 13 - 2 / 12 - 2
Temperature range	-40°C ... 80°C
Inflammability class in acc. with UL 94	V-0
Test standards	IEC 61643-11 / EN 61643-11
Remote indication contact	PDT contact
Connection data solid / stranded / AWG (IEC) / AWG (UL)	0.14 ... 1.5 mm <sup>2</sup> / 0.14 ... 1.5 mm <sup>2</sup> / 28 - 16 / 30 - 14
Max. operating voltage	250 V AC / 125 V DC (200 mA DC)
Max. operating current	1 A AC / 1 A DC (30 V DC)

#### Ordering data

Description	Type	Order No.	Pcs. / Pkt.
Type 1 + 2 lightning/surge arrester combination	FLT-SEC-T1+T2-2S-350/25-FM	2905468	1

#### Accessories

Replacement plug	L-N / L-PEN	FLT-SEC-T1-350/25-P	2905471	1
	L-N / L-PEN	VAL-SEC-T2-350-P	2905346	1
	N-PE	FLT-SEC-P-T1-N/PE-350/100-P	2905473	1

#### nsOrdering data

Description	Type	Order No.	Pcs. / Pkt.
Type 1 + 2 lightning/surge arrester combination	FLT-SEC-T1+T2-2C-350/25-FM	2905467	1

#### Accessories

Replacement plug	L-N / L-PEN	FLT-SEC-T1-350/25-P	2905471	1
	L-N / L-PEN	VAL-SEC-T2-350-P	2905346	1



new

3-conductor system; L, N, PE

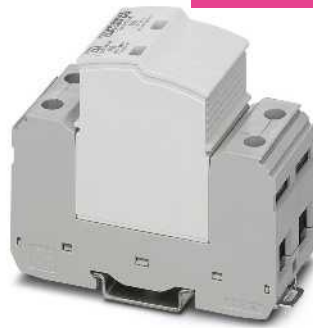

new

2-conductor system; L, PEN



new

N-PE spark gap

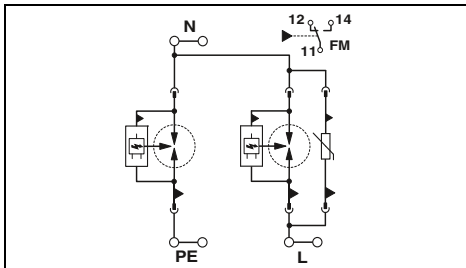

### Technical data

I + II, T1 + T2  
240 V AC (TN-S) / 240 V AC (TT)

350 V AC / - / 350 V AC / -

12.5 As / 50 As / -  
160 kJ/Ω / 2500 kJ/Ω / -  
25 kA / 100 kA / -

25 kA / 100 kA / -

≤ 1.5 kV / ≤ 1.5 kV / -

25 kA (264 V AC) / 100 A (350 V AC) / -  
25 kA (264 V AC) / 3 kA (350 V AC)  
315 A AC (gG)

≤ 25 ns / ≤ 100 ns / -

71.2 mm / 95.2 mm / 74.5 mm  
2.5 ... 35 mm<sup>2</sup> / 2.5 ... 25 mm<sup>2</sup> / 13 - 2 / 12 - 2

-40°C ... 80°C  
V-0  
IEC 61643-11 / EN 61643-11  
PDT contact  
0.14 ... 1.5 mm<sup>2</sup> / 0.14 ... 1.5 mm<sup>2</sup> / 28 - 16 / 30 - 14

250 V AC / 125 V DC (200 mA DC)  
1 A AC / 1 A DC (30 V DC)

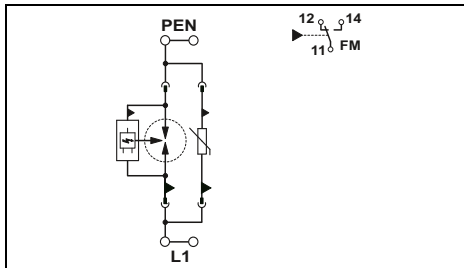

### Technical data

I + II, T1 + T2  
240 V AC (TN-C) / 240 V AC (TT)

- / - / - / 350 V AC

- / - / 12.5 As  
- / - / 160 kJ/Ω  
- / - / 25 kA

- / - / 25 kA

- / - / ≤ 1.5 kV

- / - / 25 kA (264 V AC)  
25 kA (264 V AC) / 3 kA (350 V AC)  
315 A AC (gG)

- / - / ≤ 25 ns

35.6 mm / 95.2 mm / 74.5 mm  
2.5 ... 35 mm<sup>2</sup> / 2.5 ... 25 mm<sup>2</sup> / 13 - 2 / 12 - 2

-40°C ... 80°C  
V-0  
IEC 61643-11 / EN 61643-11  
PDT contact  
0.14 ... 1.5 mm<sup>2</sup> / 0.14 ... 1.5 mm<sup>2</sup> / 28 - 16 / 30 - 14

250 V AC / 125 V DC (200 mA DC)  
1 A AC / 1 A DC (30 V DC)

### Ordering data

Type	Order No.	Pcs. / Pkt.
FLT-SEC-T1+T2-1C-350/25-FM	2905465	1

### Accessories

FLT-SEC-T1-350/25-P	2905471	1
VAL-SEC-T2-350-P	2905346	1

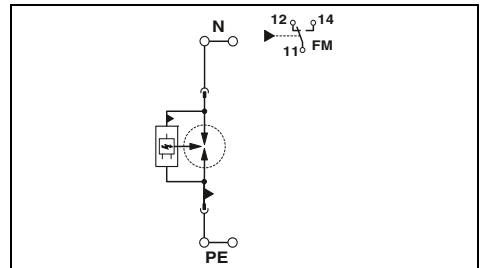

### Technical data

I / II, T1 / T2  
240 V AC (TN - only N-PE) / 240 V AC (TT - only N-PE)

- / - / 350 V AC / -

- / 50 As / -  
- / 2500 kJ/Ω / -  
- / 100 kA / -

- / 100 kA / -

- / ≤ 1.5 kV / -

- / 100 A (350 V AC) / -  
-

- / ≤ 100 ns / -

35.6 mm / 95.2 mm / 74.5 mm  
2.5 ... 35 mm<sup>2</sup> / 2.5 ... 25 mm<sup>2</sup> / 13 - 2 / 12 - 2

-40°C ... 80°C  
V-0  
IEC 61643-11 / EN 61643-11  
PDT contact  
0.14 ... 1.5 mm<sup>2</sup> / 0.14 ... 1.5 mm<sup>2</sup> / 28 - 16 / 30 - 14

250 V AC / 125 V DC (200 mA DC)  
1 A AC / 1 A DC (30 V DC)

### Ordering data

Type	Order No.	Pcs. / Pkt.
FLT-SEC-P-T1-N/PE-350/100-FM	2905472	1

### Accessories

FLT-SEC-T1-350/25-P	2905471	1
VAL-SEC-T2-350-P	2905346	1
FLT-SEC-P-T1-N/PE-350/100-P	2905473	1

# Surge protection and interference suppression filters

## Surge protection for the power supply with Safe Energy Control

### Type 2 surge arrester VALVETRAB SEC

- Varistor arrester free of leakage current
- High-performance gas-filled surge arrester for N/PE protection
- Extremely narrow design, just 12 mm per position
- Plug-in
- High continuous voltage of 350 V AC for 230/400 V AC networks with high voltage fluctuations
- Low voltage protection level of 1.5 kV
- Optical, mechanical status indicator
- With floating remote indication contact as an option
- Plugs can be checked with CHECKMASTER

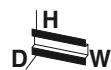

5-conductor system; L1, L2, L3, N, PE

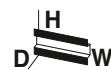

4-conductor system; L1, L2, L3, PEN

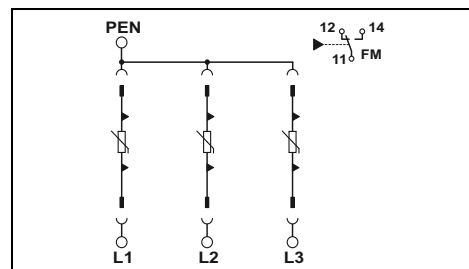
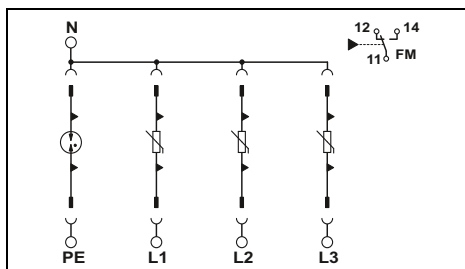

#### Technical data

Electrical data	... 350	... 175
IEC test classification	II, T2	II, T2
Nominal voltage $U_N$	240/415 V AC (TN-S) / 240/415 V AC (TT)	120/208 V AC (TN-S) / 120/208 V AC (TT)
Maximum continuous operating voltage $U_c$	L-N / N-PE / L-PEN 350 V AC / 264 V AC / -	L-N / N-PE / L-PEN 175 V AC / 150 V AC / -
Nominal discharge current $I_n$ (8/20) $\mu$ s	L-N / N-PE / L-PEN 20 kA / 20 kA / -	L-N / N-PE / L-PEN 20 kA / 20 kA / -
Max. discharge current $I_{max}$ (8/20) $\mu$ s	L-N / N-PE / L-PEN 40 kA / 40 kA / -	L-N / N-PE / L-PEN 40 kA / 40 kA / -
Voltage protection level $U_p$	L-N / N-PE / L-PEN $\leq 1.5$ kV / $\leq 1.5$ kV / -	L-N / N-PE / L-PEN $\leq 0.85$ kV / $\leq 0.95$ kV / -
Short-circuit current rating $I_{SCCR}$	L-N / N-PE / L-PEN 25 kA (in case of 315 A gG backup fuse) / 50 kA (in case of 200 A gG backup fuse)	L-N / N-PE / L-PEN 25 kA (in case of 315 A gG backup fuse) / 50 kA (in case of 200 A gG backup fuse)
Max. backup fuse with branch wiring	L-N / N-PE / L-PEN 315 A AC (gG)	L-N / N-PE / L-PEN 315 A AC (gG)
Response time $t_A$	L-N / N-PE / L-PEN $\leq 25$ ns / $\leq 100$ ns / -	L-N / N-PE / L-PEN $\leq 25$ ns / $\leq 100$ ns / -

#### Technical data

Electrical data	... 350	... 175
IEC test classification	II, T2	II, T2
Nominal voltage $U_N$	240/415 V AC (TN-C)	120/208 V AC (TN-C)
Maximum continuous operating voltage $U_c$	L-N / N-PE / L-PEN - / - / 350 V AC	L-N / N-PE / L-PEN - / - / 175 V AC
Nominal discharge current $I_n$ (8/20) $\mu$ s	L-N / N-PE / L-PEN - / - / 20 kA	L-N / N-PE / L-PEN - / - / 20 kA
Max. discharge current $I_{max}$ (8/20) $\mu$ s	L-N / N-PE / L-PEN - / - / 40 kA	L-N / N-PE / L-PEN - / - / 40 kA
Voltage protection level $U_p$	L-N / N-PE / L-PEN - / - / $\leq 1.5$ kV	L-N / N-PE / L-PEN - / - / $\leq 0.85$ kV
Short-circuit current rating $I_{SCCR}$	L-N / N-PE / L-PEN 25 kA (in case of 315 A gG backup fuse) / 50 kA (in case of 200 A gG backup fuse)	L-N / N-PE / L-PEN 25 kA (in case of 315 A gG backup fuse) / 50 kA (in case of 200 A gG backup fuse)
Max. backup fuse with branch wiring	L-N / N-PE / L-PEN 315 A AC (gG)	L-N / N-PE / L-PEN 315 A AC (gG)
Response time $t_A$	L-N / N-PE / L-PEN - / - / $\leq 25$ ns	L-N / N-PE / L-PEN - / - / $\leq 25$ ns

General data	Dimensions W / H / D
Temperature range	-40°C ... 80°C
Inflammability class in acc. with UL 94	V-0
Test standards	IEC 61643-11 / EN 61643-11
Remote indication contact	PDT contact
Connection data solid / stranded / AWG (IEC) / AWG (UL)	0.14 ... 1.5 mm <sup>2</sup> / 0.14 ... 1.5 mm <sup>2</sup> / 28 - 16 / 30 - 14
Max. operating voltage	250 V AC / 125 V DC (200 mA DC)
Max. operating current	1 A AC / 1 A DC (30 V DC)

General data	Dimensions W / H / D
Temperature range	-40°C ... 80°C
Inflammability class in acc. with UL 94	V-0
Test standards	IEC 61643-11 / EN 61643-11
Remote indication contact	PDT contact
Connection data solid / stranded / AWG (IEC) / AWG (UL)	0.14 ... 1.5 mm <sup>2</sup> / 0.14 ... 1.5 mm <sup>2</sup> / 28 - 16 / 30 - 14
Max. operating voltage	250 V AC / 125 V DC (200 mA DC)
Max. operating current	1 A AC / 1 A DC (30 V DC)

#### Ordering data

Description	Type	Order No.	Pcs. / Pkt.
	VALVETRAB SEC	VAL-SEC-T2-3S-350-FM	2905340
	VAL-SEC-T2-3S-350	2905345	1
	VAL-SEC-T2-3S-175-FM	2905354	1

#### Ordering data

Description	Type	Order No.	Pcs. / Pkt.
	VALVETRAB SEC	VAL-SEC-T2-3C-350-FM	2905339
	VAL-SEC-T2-3C-350	2905344	1
	VAL-SEC-T2-3C-175-FM	2905353	1

#### Accessories

Replacement plug	L-N / L-PEN N-PE L-N / L-PEN N-PE	Type	Order No.	Pcs. / Pkt.
		VAL-SEC-T2-350-P	2905346	1
	VAL-SEC-T2-N/PE-350-P	2905347	1	
	VAL-SEC-T2-175-P	2905355	1	
	VAL-SEC-T2-N/PE-175-P	2905356	1	

#### Accessories

Replacement plug	L-N / L-PEN N-PE L-N / L-PEN N-PE	Type	Order No.	Pcs. / Pkt.
		VAL-SEC-T2-350-P	2905346	1
	VAL-SEC-T2-175-P	2905355	1	

# Surge protection and interference suppression filters

## Surge protection for the power supply with Safe Energy Control



new

4-conductor system; L1, L2, N, PE

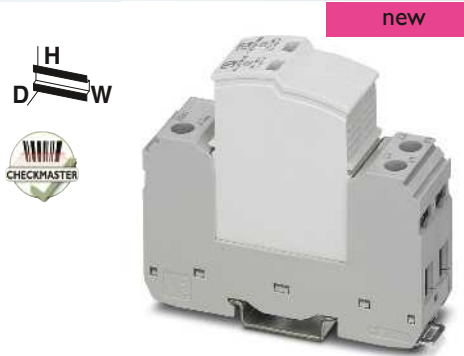

new

3-conductor system; L1, L2, PEN

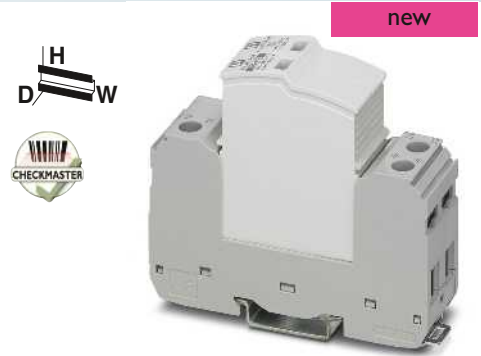

new

3-conductor system; L, N, PE

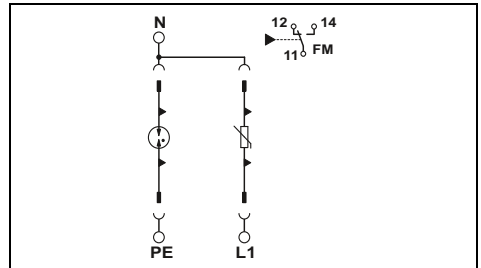
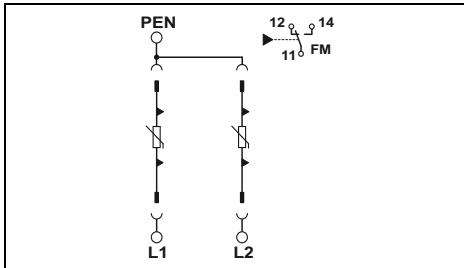
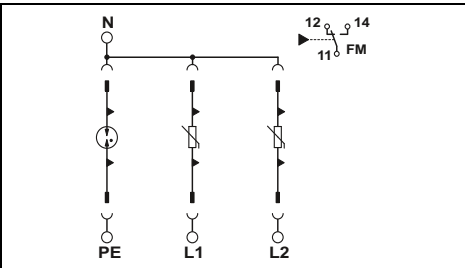

### Technical data

... 350	... 175
II, T2	II, T2
240/415 V AC (TN-S) / 240/415 V AC (TT)	120/208 V AC (TN-S) / 120/208 V AC (TT)
350 V AC / 264 V AC / -	175 V AC / 150 V AC / -
20 kA / 20 kA / -	20 kA / 20 kA / -
40 kA / 40 kA / -	40 kA / 40 kA / -
≤ 1.5 kV / ≤ 1.5 kV / -	≤ 0.85 kV / ≤ 0.95 kV / -
25 kA (in case of 315 A gG backup fuse) / 50 kA (in case of 200 A gG backup fuse)	25 kA (in case of 315 A gG backup fuse) / 50 kA (in case of 200 A gG backup fuse)
315 A AC (gG)	315 A AC (gG)
≤ 25 ns / ≤ 100 ns / -	≤ 25 ns / ≤ 100 ns / -

### Technical data

... 350	... 175
II, T2	II, T2
240/415 V AC (TN-C)	120/208 V AC (TN-C)
- / - / 350 V AC	- / - / 175 V AC
- / - / 20 kA	- / - / 20 kA
- / - / 40 kA	- / - / 40 kA
- / - / ≤ 1.5 kV	- / - / ≤ 0.85 kV
25 kA (in case of 315 A gG backup fuse) / 50 kA (in case of 200 A gG backup fuse)	25 kA (in case of 315 A gG backup fuse) / 50 kA (in case of 200 A gG backup fuse)
315 A AC (gG)	315 A AC (gG)
- / - / ≤ 25 ns	- / - / ≤ 25 ns

### Technical data

... 350	... 175
II, T2	II, T2
240 V AC (TN-S) / 240 V AC (TT)	120 V AC (TN-S) / 120 V AC (TT)
350 V AC / 264 V AC / -	175 V AC / 150 V AC / -
20 kA / 20 kA / -	20 kA / 20 kA / -
40 kA / 40 kA / -	40 kA / 40 kA / -
≤ 1.5 kV / ≤ 1.5 kV / -	≤ 0.85 kV / ≤ 0.95 kV / -
25 kA (in case of 315 A gG backup fuse) / 50 kA (in case of 200 A gG backup fuse)	25 kA (in case of 315 A gG backup fuse) / 50 kA (in case of 200 A gG backup fuse)
315 A AC (gG)	315 A AC (gG)
≤ 25 ns / ≤ 100 ns / -	≤ 25 ns / ≤ 100 ns / -

37.3 mm / 97.9 mm / 74.5 mm  
2.5 ... 25 mm<sup>2</sup> / 2.5 ... 16 mm<sup>2</sup> / 12 - 4 / 14 - 2

-40°C ... 80°C  
V-0

IEC 61643-11 / EN 61643-11

PDT contact

0.14 ... 1.5 mm<sup>2</sup> / 0.14 ... 1.5 mm<sup>2</sup> / 28 - 16 / 30 - 14

250 V AC / 125 V DC (200 mA DC)  
1 A AC / 1 A DC (30 V DC)

25.4 mm / 97.9 mm / 74.5 mm  
2.5 ... 25 mm<sup>2</sup> / 2.5 ... 16 mm<sup>2</sup> / 12 - 4 / 14 - 2

-40°C ... 80°C  
V-0

IEC 61643-11 / EN 61643-11

PDT contact

0.14 ... 1.5 mm<sup>2</sup> / 0.14 ... 1.5 mm<sup>2</sup> / 28 - 16 / 30 - 14

250 V AC / 125 V DC (200 mA DC)  
1 A AC / 1 A DC (30 V DC)

25.4 mm / 97.9 mm / 74.5 mm  
2.5 ... 25 mm<sup>2</sup> / 2.5 ... 16 mm<sup>2</sup> / 12 - 4 / 14 - 2

-40°C ... 80°C  
V-0

IEC 61643-11 / EN 61643-11

PDT contact

0.14 ... 1.5 mm<sup>2</sup> / 0.14 ... 1.5 mm<sup>2</sup> / 28 - 16 / 30 - 14

250 V AC / 125 V DC (200 mA DC)  
1 A AC / 1 A DC (30 V DC)

### Ordering data

Type	Order No.	Pcs. / Pkt.
VAL-SEC-T2-2S-350-FM	2905338	1
VAL-SEC-T2-2S-350	2905343	1
VAL-SEC-T2-2S-175-FM	2905351	1

### Ordering data

Type	Order No.	Pcs. / Pkt.
VAL-SEC-T2-2C-350-FM	2905337	1
VAL-SEC-T2-2C-350	2905342	1
VAL-SEC-T2-2C-175-FM	2905350	1

### Ordering data

Type	Order No.	Pcs. / Pkt.
VAL-SEC-T2-1S-350-FM	2905333	1
VAL-SEC-T2-1S-350	2905341	1
VAL-SEC-T2-1S-175-FM	2905348	1

### Accessories

Type	Order No.	Pcs. / Pkt.
VAL-SEC-T2-350-P	2905346	1
VAL-SEC-T2-N/PE-350-P	2905347	1
VAL-SEC-T2-175-P	2905355	1
VAL-SEC-T2-N/PE-175-P	2905356	1

### Accessories

Type	Order No.	Pcs. / Pkt.
VAL-SEC-T2-350-P	2905346	1
VAL-SEC-T2-175-P	2905355	1

### Accessories

Type	Order No.	Pcs. / Pkt.
VAL-SEC-T2-350-P	2905346	1
VAL-SEC-T2-N/PE-350-P	2905347	1
VAL-SEC-T2-175-P	2905355	1
VAL-SEC-T2-N/PE-175-P	2905356	1

# Surge protection and interference suppression filters

## Surge protection for the power supply with Safe Energy Control

### Type 3 device protection PLUGTRAB SEC

- Varistor-based device protection
- For single and three-phase power supply units
- Plug-in
- Can be used without separate backup fuse thanks to integrated overcurrent protection
- Optical status indicator via LED
- With floating remote indication contact
- Plugs can be checked with CHECKMASTER



new

5-conductor system; L1, L2, L3, N, PE

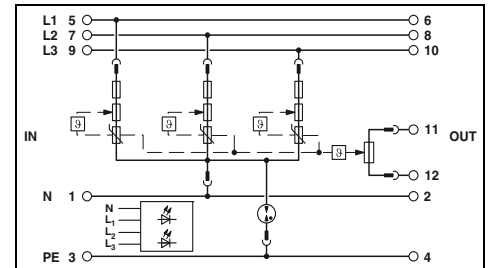

#### Technical data

Electrical data	... 230AC
IEC test classification	III / T3
Nominal voltage $U_N$	230 V AC
Maximum continuous operating voltage $U_C$	264 V AC
Rated load current $I_L$	26 A (30°C)
Combined surge $U_{OC}$	6 kV
Nominal discharge current $I_n$ (8/20) $\mu$ s	3 kA
Protection level $U_p$	L-N / L(N)-PE $\leq 1.4$ kV / $\leq 1.5$ kV
Short-circuit current rating $I_{SCCR}$	-
Max. backup fuse with branch wiring	Not required
Response time $t_A$	L-N / L(N)-PE $\leq 25$ ns / $\leq 100$ ns
General data	
Dimensions W / H / D	35.4 mm / 90 mm / 74.5 mm
Connection data solid / stranded / AWG	0.2 ... 4 mm <sup>2</sup> / 0.2 ... 2.5 mm <sup>2</sup> / 24 - 12
Temperature range	-40°C ... 70°C
Inflammability class in acc. with UL 94	V-0
Test standards	IEC 61643-11 / EN 61643-11
Remote indication contact	N/C contact
Connection data solid / stranded / AWG	0.2 ... 4 mm <sup>2</sup> / 0.2 ... 2.5 mm <sup>2</sup> / 24 - 12
Max. operating voltage	250 V AC / 125 V DC
Max. operating current	3 A AC / 1 A DC (30 V DC)

#### Ordering data

Description	Voltage $U_N$	Type	Order No.	Pcs. / Pkt.
<b>MAINS-PLUGTRAB</b> , consisting of a plug and base element				
	24 V AC			
	60 V AC			
	120 V AC			
	230 V AC	<b>PLT-SEC-T3-3S-230-FM</b>	<b>2905230</b>	1
<b>MAINS-PLUGTRAB plug</b>	24 V AC			
	60 V AC			
	120 V AC			
	230 V AC			

#### Accessories

<b>Replacement plug</b>				
<b>PLUGTRAB base element</b> , for mounting on NS 35		<b>PLT-SEC-T3-3S-230-P</b>	<b>2905236</b>	1
		<b>PLT-SEC-T3-3S-BE</b>	<b>2905592</b>	1



new

3-conductor system; L, N, PE



new

Replacement plug for 3-conductor system; L, N, PE

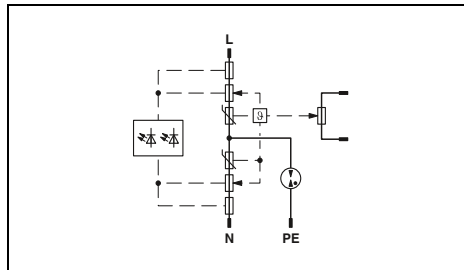
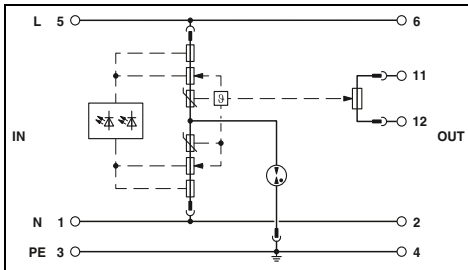

### Technical data

... 24AC	... 60AC	... 120AC	... 230AC
III / T3	III / T3	III / T3	III / T3
24 V AC	60 V AC	120 V AC	230 V AC
34 V AC / 34 V DC	100 V AC / 80 V DC	150 V AC / 150 V DC	264 V AC / 230 V DC
26 A (30°C)	26 A (30°C)	26 A (30°C)	26 A (30°C)
2 kV	4 kV	6 kV	6 kV
1 kA	2 kA	3 kA	3 kA
≤ 0.25 kV / ≤ 0.65 kV	≤ 0.48 kV / ≤ 0.9 kV	≤ 0.85 kV / ≤ 0.95 kV	≤ 1.35 kV / ≤ 1.5 kV
1.5 kA AC / 1 kA DC	1.5 kA AC / 1 kA DC	1.5 kA AC / 0.25 kA DC	1.5 kA AC / 0.25 kA DC
Not required			
≤ 25 ns / ≤ 100 ns	≤ 25 ns / ≤ 100 ns	≤ 25 ns / ≤ 100 ns	≤ 25 ns / ≤ 100 ns

### Technical data

... 24AC	... 60AC	... 120AC	... 230AC
III / T3	III / T3	III / T3	III / T3
24 V AC	60 V AC	120 V AC	230 V AC
34 V AC / 34 V DC	100 V AC / 80 V DC	150 V AC / 150 V DC	264 V AC / 230 V DC
-	-	-	-
2 kV	4 kV	6 kV	6 kV
1 kA	2 kA	3 kA	3 kA
≤ 0.25 kV / ≤ 0.65 kV	≤ 0.48 kV / ≤ 0.9 kV	≤ 0.85 kV / ≤ 0.95 kV	≤ 1.35 kV / ≤ 1.5 kV
1.5 kA AC / 1 kA DC	1.5 kA AC / 1 kA DC	1.5 kA AC / 0.25 kA DC	1.5 kA AC / 0.25 kA DC
-			
≤ 25 ns / ≤ 100 ns	≤ 25 ns / ≤ 100 ns	≤ 25 ns / ≤ 100 ns	≤ 25 ns / ≤ 100 ns

17.7 mm / 90 mm / 74.5 mm  
0.2 ... 4 mm<sup>2</sup> / 0.2 ... 2.5 mm<sup>2</sup> / 24 - 12  
-40°C ... 80°C  
V-0

EN 61643-11 / UL1449

N/C contact

0.2 ... 4 mm<sup>2</sup> / 0.2 ... 2.5 mm<sup>2</sup> / 24 - 12  
250 V AC / 125 V DC  
3 A AC / 1 A DC (30 V DC)

17.5 mm / 60.9 mm / 44.8 mm  
- / - / -  
-40°C ... 80°C  
V-0

EN 61643-11 / UL1449

### Ordering data

Type	Order No.	Pcs. / Pkt.
PLT-SEC-T3-24-FM	2905223	1
PLT-SEC-T3-60-FM	2905225	1
PLT-SEC-T3-120-FM	2905228	1
PLT-SEC-T3-230-FM	2905229	1

### Ordering data

Type	Order No.	Pcs. / Pkt.
PLT-SEC-T3-24-P	2905232	1
PLT-SEC-T3-60-P	2905233	1
PLT-SEC-T3-120-P	2905234	1
PLT-SEC-T3-230-P	2905235	1

### Accessories

Type	Order No.	Pcs. / Pkt.
PLT-SEC-T3-BE	2905557	1

### Accessories

Type	Order No.	Pcs. / Pkt.
PLT-SEC-T3-BE	2905557	1



### Type 1 lightning arresters for harsh industrial environments

With a rated voltage of 800 V AC, discharge capacity of 35 kA per channel, and robust housing design, POWERTRAB is ideal for harsh industrial environments and use in 690 V IT networks, such as in wind power plants.



### VAL-MS T1/T2 ...

The VAL-MS T1/T2 ... varistor-based lightning arresters meet the requirements of Lightning Protection Level III and IV and also provide the voltage protection level of a type 2 surge arrester.



### Protective plugs for American applications

The special plugs designed for American networks enable the easy implementation of DIN-rail-mountable surge protection solutions.



### Surge protection for 60 mm system technology

VAL-CP-MOSO... are surge arresters with integrated, surge-proof arrester backup fuse for installation on 60 mm system technology.



### Type 3 device protection in an extremely compact design

Ideal for protecting end devices, type 3 device protection is used in deep installation boxes, cable ducts or underfloor systems.



### Device protection plugs - MNT

The MAINTRAB device protection range is very easy to retrofit in existing installations. Versions are available as simple adapters for mains sockets or with additional signal interfaces.





### Type 2 surge protection for higher nominal voltages

With VAL-MS..., corresponding arresters are available for power supplies with higher supply voltages, such as in wind power plants or when discharge currents > 30 kA per channel are required.



### Surge protection with residual current device

VAL-CP-RCD... are combinations of type 2 device protection with residual current protection. They therefore combine personal protection and surge protection in a single device.



### Surge protection with integrated arrester backup fuse

VAL-CP-MCB... are combinations of type 2 surge protection with integrated, surge-proof arrester backup fuses.



### Surge protection for LED lights

The surge protective devices for LED applications are specifically designed for street, tunnel or object lighting. Different versions are available for protection class I and II.



### Surge protection for photovoltaic systems

The product range covers everything from individual components to ready-to-install solutions for all types of photovoltaic systems from 600 V DC to 1500 V DC.



### Surge protection set

The basic solution for building installations. The GEB-SET... consists of a T1/T2 arrester and three MAINTRAB device protection plugs.

# Surge protection and interference suppression filters

## Surge protection for the power supply

### Type 1 lightning arrester POWERTRAB

- Type 1 arrester based on a varistor
- Meets Lightning Protection Level I
- Universal solution for various network types
- Multi-stage status monitoring via remote indication contact
- Local optical status indication
- Encapsulated, non-extinguishing
- Free of leakage current/no line follow current
- Very high TOV resistance
- Meets installation requirements according to CLC/TS 50539-22
- Use in harsh industrial environments



Single-channel

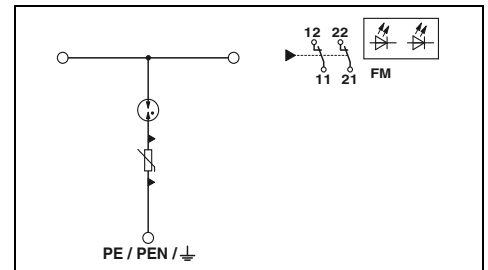

#### Technical data

<b>Electrical data</b>		I / II, T1 / T2
IEC test classification		690 V AC / 554/960 V AC (TN-C) / 690 V AC (IT)
Nominal voltage $U_N$		
Maximum continuous operating voltage $U_c$	L-PE	800 V AC
Impulse discharge curr. $I_{imp}$ (10/350) $\mu$ s	L-PE	17.5 As
Charge	L-PE	305 kJ/ $\Omega$
Specific energy	L-PE	35 kA
Peak value	L-PE	35 kA
Nominal discharge current $I_n$ (8/20) $\mu$ s	L-PE	100 kA
Max. discharge current $I_{max}$ (8/20) $\mu$ s	L-PE	$\leq 2.2$ kV
Residual voltage at 5 kA	L-PE	$\leq 4.5$ kV
Protection level $U_p$	L-PE	50 kA
Short-circuit current rating $I_{SCCR}$	L-PE	$\leq 100$ ns
Response time $t_A$		
<b>General data</b>		
Dimensions W / H / D		56 mm / 191 mm / 280 mm
Connection data solid / stranded / AWG (IEC) / AWG (UL)		16 ... 50 mm <sup>2</sup> / 16 ... 50 mm <sup>2</sup> / 6 - 1/0 / 6 - 1/0
Temperature range		-40°C ... 80°C
Inflammability class in acc. with UL 94		V-2
Test standards		IEC 61643-11 / EN 61643-11
Remote indication contact		2x N/C contacts, 1-pos.
Connection data solid / stranded / AWG (IEC) / AWG (UL)		0.2 ... 2.5 mm <sup>2</sup> / 0.2 ... 2.5 mm <sup>2</sup> / 24 - 12 / 24 - 12
Max. operating voltage		30 V AC / 30 V DC
Max. operating current		1.5 A AC / 1.5 A DC

#### Ordering data

Description	Type	Order No.	Pcs. / Pkt.
<b>POWERTRAB</b>	<b>PWT 35-800AC-FM</b>	<b>2800419</b>	<b>1</b>
<b>Montage set</b> , consisting of: PE aluminum rail, M10 x 20 hexagonal screws, M10 hexagonal nuts, M10 washers, M10 spring washers, installation instructions			



4-conductor system; L1, L2, L3, PE/PEN



Mounting set for 3+0 applications



Mounting set for 4+0 applications

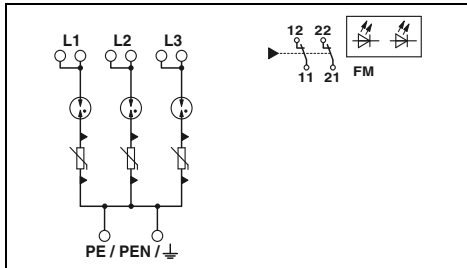

### Technical data

I / II, T1 / T2  
690 V AC / 554/960 V AC (TN-C) / 690 V AC (IT)

800 V AC

17.5 As  
305 kJ/Ω  
35 kA  
35 kA  
100 kA  
≤ 2.2 kV  
≤ 4.5 kV  
50 kA  
≤ 100 ns

176 mm / 191 mm / 280 mm  
16 ... 50 mm<sup>2</sup> / 16 ... 50 mm<sup>2</sup> / 6 - 1/0 / 6 - 1/0

-40°C ... 80°C  
V-2

IEC 61643-11 / EN 61643-11

2x N/C contacts, 1-pos.

0.2 ... 2.5 mm<sup>2</sup> / 0.2 ... 2.5 mm<sup>2</sup> / 24 - 12 / 24 - 12

30 V AC / 30 V DC  
1.5 A AC / 1.5 A DC

### Ordering data

Type	Order No.	Pcs. / Pkt.
PWT 100-800AC-FM	2800531	1

### Ordering data

Type	Order No.	Pcs. / Pkt.
PWT CCT-SET	2800532	1

### Ordering data

Type	Order No.	Pcs. / Pkt.
PWT CCT-SET 4	2905613	1

# Surge protection and interference suppression filters

## Surge protection for the power supply

### Type 1/2 lightning arrester/surge arrester

#### VAL-MS-T1/T2

- Consistent plug-in design (even for N/PE spark gap)
- Secure hold of plugs in the event of high lightning current loads and strong vibration thanks to new latching
- Thermal disconnect device for each individual plug
- Optical, mechanical status indication for the individual arresters
- With or without floating remote indication contact
- Mechanical coding of all slots
- Plugs can be checked with CHECKMASTER

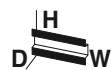

5-conductor system; L1, L2, L3, N, PE (3+1 circuit)



5-conductor system; L1, L2, L3, N, PE (4+0 circuit)

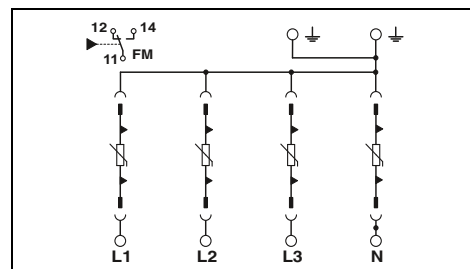
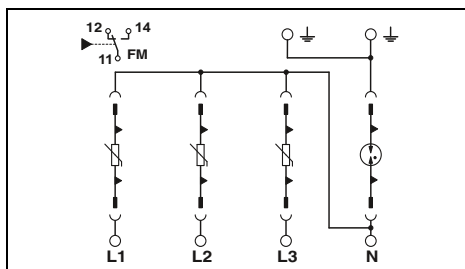

#### Technical data

Electrical data	...335	...175
IEC test classification	I / II, T1 / T2	I / II, T1 / T2
Nominal voltage $U_N$	240/415 V AC (TN-S) / 240/415 V AC (TT)	120/208 V AC (TN-S) / 120/208 V AC (TT)
Maximum continuous operating voltage $U_c$	L-N / L-PE / N-PE / L-PEN	335 V AC / - / 264 V AC / -
Impulse discharge curr. $I_{imp}$ (10/350) $\mu$ s	L-N / N-PE / L-PEN	6.25 As / 25 As / -
Charge	L-N / N-PE / L-PEN	39 kJ/ $\Omega$ / 625 kJ/ $\Omega$ / -
Specific energy	L-N / N-PE / L-PEN	12.5 kA / 50 kA / -
Peak value	L-N / N-PE / L-PEN	12.5 kA / 12.5 kA / 50 kA / -
Nominal discharge current $I_n$ (8/20) $\mu$ s	L-N / L-PE / N-PE / L-PEN	50 kA / 50 kA / 50 kA / -
Max. discharge current $I_{max}$ (8/20) $\mu$ s	L-N / L-PE / N-PE / L-PEN	$\leq 1.2$ kV / $\leq 2$ kV / $\leq 1.7$ kV / -
Voltage protection level $U_p$	L-N / L-PE / N-PE / L-PEN	$\leq 0.8$ kV / $\leq 2$ kV / $\leq 1.7$ kV / -
Short-circuit current rating $I_{SCCR}$		25 kA
Max. backup fuse with branch wiring		160 A AC (gG)
Response time $t_d$	L-N / L-PE / N-PE / L-PEN	$\leq 25$ ns / $\leq 100$ ns / $\leq 100$ ns / -

General data	
Dimensions W / H / D	71.2 mm / 99 mm / 77.5 mm
Connection data solid / stranded / AWG (IEC) / AWG (UL)	1.5 ... 35 mm <sup>2</sup> / 1.5 ... 25 mm <sup>2</sup> / 15 - 2 / 10 - 2
Temperature range	-40°C ... 80°C
Inflammability class in acc. with UL 94	V-0
Test standards	IEC 61643-11 / EN 61643-11
Remote indication contact	PDT contact
Connection data solid / stranded / AWG (IEC) / AWG (UL)	0.14 ... 1.5 mm <sup>2</sup> / 0.14 ... 1.5 mm <sup>2</sup> / 28 - 16 / 30 - 14
Max. operating voltage	250 V AC / 30 V DC
Max. operating current	1.5 A AC / 1 A DC

#### Ordering data

Description	$U_c$
VALVETRAB-MS, varistor-based lightning arrester	
with remote indication contact	335 V AC
without remote indication contact	335 V AC
with remote indication contact	175 V AC
without remote indication contact	175 V AC

Type	Order No.	Pcs. / Pkt.
VAL-MS-T1/T2 335/12.5/3+1-FM	2800183	1
VAL-MS-T1/T2 335/12.5/3+1	2800184	1
VAL-MS-T1/T2 175/12.5/3+1-FM	2800670	1
VAL-MS-T1/T2 175/12.5/3+1	2800671	1

#### Accessories

Replacement plug	
L-N / L-PEN	
L-N / L-PEN	
N-PE	

Type	Order No.	Pcs. / Pkt.
VAL-MS-T1/T2 335/12.5 ST	2800190	10
VAL-MS-T1/T2 175/12.5 ST	2800676	10
F-MS-T1/T2 50 ST	2800191	10

#### Technical data

Electrical data	...335
IEC test classification	I / II, T1 / T2
Nominal voltage $U_N$	240/415 V AC (TN-S)
Maximum continuous operating voltage $U_c$	L-N / L-PE / N-PE / L-PEN
Impulse discharge curr. $I_{imp}$ (10/350) $\mu$ s	- / 6.25 As / -
Charge	- / 39 kJ/ $\Omega$ / -
Specific energy	- / 12.5 kA / -
Peak value	- / 12.5 kA / -
Nominal discharge current $I_n$ (8/20) $\mu$ s	- / 12.5 kA / 12.5 kA / -
Max. discharge current $I_{max}$ (8/20) $\mu$ s	- / 50 kA / 50 kA / -
Voltage protection level $U_p$	$\leq 1.6$ kV (30 kA - 8/20 $\mu$ s) / $\leq 1.2$ kV / $\leq 1.2$ kV / -
Short-circuit current rating $I_{SCCR}$	25 kA
Max. backup fuse with branch wiring	160 A AC (gG)
Response time $t_d$	- / $\leq 25$ ns / $\leq 25$ ns / -

General data	
Dimensions W / H / D	71.2 mm / 99 mm / 77.5 mm
Connection data solid / stranded / AWG (IEC) / AWG (UL)	1.5 ... 35 mm <sup>2</sup> / 1.5 ... 25 mm <sup>2</sup> / 15 - 2 / 10 - 2
Temperature range	-40°C ... 80°C
Inflammability class in acc. with UL 94	V-0
Test standards	IEC 61643-11 / EN 61643-11
Remote indication contact	PDT contact
Connection data solid / stranded / AWG (IEC) / AWG (UL)	0.14 ... 1.5 mm <sup>2</sup> / 0.14 ... 1.5 mm <sup>2</sup> / 28 - 16 / 30 - 14
Max. operating voltage	250 V AC / 30 V DC
Max. operating current	1.5 A AC / 1 A DC

#### Ordering data

Type	Order No.	Pcs. / Pkt.
VAL-MS-T1/T2 335/12.5/4+0-FM	2800644	1
VAL-MS-T1/T2 335/12.5/4+0	2800645	1

#### Accessories

Type	Order No.	Pcs. / Pkt.
VAL-MS-T1/T2 335/12.5 ST	2800190	10



4-conductor system; L1, L2, L3, PEN



3-conductor system; L, N, PE



2-conductor system; L, N/PEN

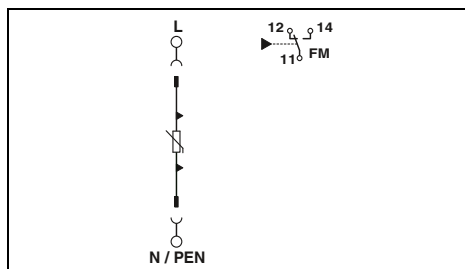
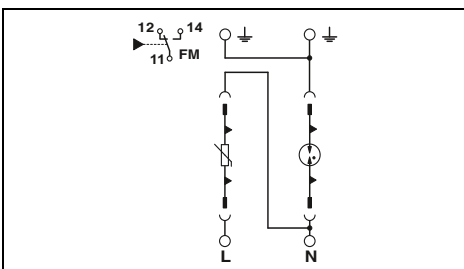
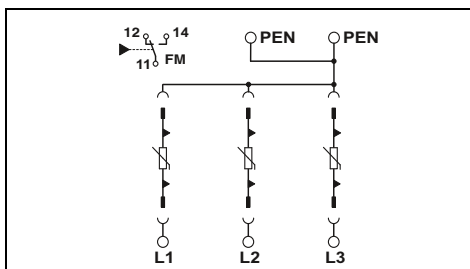

### Technical data

...335	...175
I / II, T1 / T2	I / II, T1 / T2
240/415 V AC (TN-C)	120/208 V AC (TN-C)
- / - / - / 335 V AC	- / - / - / 175 V AC
- / - / 6.25 As	- / - / 6.25 As
- / - / 39 kJ/Ω	- / - / 39 kJ/Ω
- / - / 12.5 kA	- / - / 12.5 kA
- / - / - / 12.5 kA	- / - / - / 12.5 kA
- / - / - / 50 kA	- / - / - / 50 kA
- / - / - / ≤ 1.6 kV (30 kA - 8/20μs)	- / - / - / ≤ 0.8 kV
160 A AC (gG)	25 kA 160 A AC (gG)
- / - / - / ≤ 25 ns	- / - / - / ≤ 25 ns

### Technical data

...335	...175
I / II, T1 / T2	I / II, T1 / T2
240 V AC (TN-S) / 240 V AC (TT)	120 V AC (TN-S) / 120 V AC (TT)
335 V AC / - / 264 V AC / -	175 V AC / - / 264 V AC / -
6.25 As / 25 As / -	6.25 As / 25 As / -
39 kJ/Ω / 625 kJ/Ω / -	39 kJ/Ω / 625 kJ/Ω / -
12.5 kA / 50 kA / -	12.5 kA / 50 kA / -
12.5 kA / - / 50 kA / -	12.5 kA / - / 50 kA / -
50 kA / - / 50 kA / -	50 kA / - / 50 kA / -
≤ 1.2 kV / ≤ 2 kV / ≤ 1.7 kV / -	≤ 0.8 kV / ≤ 2 kV / ≤ 1.7 kV / -
160 A AC (gG)	25 kA 160 A AC (gG)
≤ 25 ns / ≤ 100 ns / ≤ 100 ns / -	≤ 25 ns / ≤ 100 ns / ≤ 100 ns / -

### Technical data

...335	...175
I / II, T1 / T2	I / II, T1 / T2
240 V AC (TN-C, TN-S) / 240 V AC (TT)	120 V AC (TN-C, TN-S) / 120 V AC (TT)
335 V AC / - / - / 335 V AC	175 V AC / - / - / 175 V AC
6.25 As / - / 6.25 As	6.25 As / - / 6.25 As
39 kJ/Ω / - / 39 kJ/Ω	39 kJ/Ω / - / 39 kJ/Ω
12.5 kA / - / 12.5 kA	12.5 kA / - / 12.5 kA
12.5 kA / - / - / 12.5 kA	12.5 kA / - / - / 12.5 kA
50 kA / - / - / 50 kA	50 kA / - / - / 50 kA
≤ 1.6 kV (30 kA - 8/20μs) / - / - / -	≤ 0.8 kV / - / - / - / ≤ 0.8 kV
160 A AC (gG)	25 kA 160 A AC (gG)
≤ 25 ns / - / - / ≤ 25 ns	≤ 25 ns / - / - / ≤ 25 ns

53.4 mm / 99 mm / 77.5 mm  
1.5 ... 35 mm<sup>2</sup> / 1.5 ... 25 mm<sup>2</sup> / 15 - 2 / 10 - 2

-40°C ... 80°C  
V-0

IEC 61643-11 / EN 61643-11

PDT contact

0.14 ... 1.5 mm<sup>2</sup> / 0.14 ... 1.5 mm<sup>2</sup> / 28 - 16 / 30 - 14

250 V AC / 30 V DC  
1.5 A AC / 1 A DC

35.6 mm / 99 mm / 77.5 mm  
1.5 ... 35 mm<sup>2</sup> / 1.5 ... 25 mm<sup>2</sup> / 15 - 2 / 10 - 2

-40°C ... 80°C  
V-0

IEC 61643-11 / EN 61643-11 / EN 61643-11/A11

PDT contact

0.14 ... 1.5 mm<sup>2</sup> / 0.14 ... 1.5 mm<sup>2</sup> / 28 - 16 / 30 - 14

250 V AC / 30 V DC  
1.5 A AC / 1 A DC

17.5 mm / 99 mm / 77.5 mm  
1.5 ... 35 mm<sup>2</sup> / 1.5 ... 25 mm<sup>2</sup> / 15 - 2 / -

-40°C ... 80°C  
V-0

IEC 61643-11 / EN 61643-11

PDT contact

0.14 ... 1.5 mm<sup>2</sup> / 0.14 ... 1.5 mm<sup>2</sup> / - / -

250 V AC / 30 V DC  
1 A AC / 1 A DC

### Ordering data

Type	Order No.	Pcs. / Pkt.
VAL-MS-T1/T2 335/12.5/3+0-FM	2800188	1
VAL-MS-T1/T2 335/12.5/3+0	2800189	1
VAL-MS-T1/T2 175/12.5/3+0-FM	2800672	1
VAL-MS-T1/T2 175/12.5/3+0	2800673	1

### Accessories

VAL-MS-T1/T2 335/12.5 ST	2800190	10
VAL-MS-T1/T2 175/12.5 ST	2800676	10

### Ordering data

Type	Order No.	Pcs. / Pkt.
VAL-MS-T1/T2 335/12.5/1+1-FM	2800186	1
VAL-MS-T1/T2 335/12.5/1+1	2800187	1
VAL-MS-T1/T2 175/12.5/1+1-FM	2800674	1
VAL-MS-T1/T2 175/12.5/1+1	2800675	1

### Accessories

VAL-MS-T1/T2 335/12.5 ST	2800190	10
VAL-MS-T1/T2 175/12.5 ST	2800676	10
F-MS-T1/T2 50 ST	2800191	10

### Ordering data

Type	Order No.	Pcs. / Pkt.
VAL-MS-T1/T2 335/12.5/1+0-FM	2801042	1
VAL-MS-T1/T2 335/12.5/1+0	2801041	1
VAL-MS-T1/T2 175/12.5/1+0-FM	2801044	1
VAL-MS-T1/T2 175/12.5/1+0	2801043	1

### Accessories

VAL-MS-T1/T2 335/12.5 ST	2800190	10
VAL-MS-T1/T2 175/12.5 ST	2800676	10

# Surge protection and interference suppression filters

## Surge protection for the power supply

### Surge protection for special applications

- Consistent plug-in design
- Also suitable for industry solutions, e.g., in the rail and telecommunications sectors
- Thermal disconnect device for each individual plug
- Optical, mechanical status indication for the individual arresters
- With or without floating remote indication contact
- Mechanical coding of all slots
- Plugs can be checked with CHECKMASTER



2-conductor system; L, PEN



3-conductor system; L, N, PE

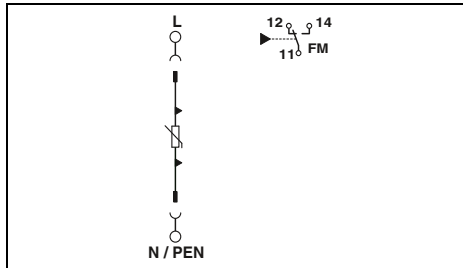

#### Technical data

Electrical data		
IEC test classification		I / II, T1 / T2
Nominal voltage $U_N$		60 V AC $\pm 10\%$ (TN)
Maximum continuous operating voltage $U_C$	L-N / N-PE / L-PEN	75 V AC / - / 75 V AC
Impulse discharge curr. $I_{imp}$ (10/350) $\mu$ s	L-N / N-PE / L-PEN	6.25 As / - / 6.25 As
Charge	L-N / N-PE / L-PEN	39 kJ/ $\Omega$ / - / 39 kJ/ $\Omega$
Specific energy	L-N / N-PE / L-PEN	12.5 kA / - / 12.5 kA
Peak value	L-N / N-PE / L-PEN	12.5 kA / - / 12.5 kA
Nominal discharge current $I_n$ (8/20) $\mu$ s	L-N / N-PE / L-PEN	12.5 kA / - / 12.5 kA
Max. discharge current $I_{max}$ (8/20) $\mu$ s	L-N / N-PE / L-PEN	30 kA / - / 30 kA
Voltage protection level $U_p$	L-N / N-PE / L-PEN	$\leq 0.4$ kV / - / $\leq 0.4$ kV
Short-circuit current rating $I_{SCCR}$	L-N / N-PE / L-PEN	25 kA
Response time $t_A$	L-N / N-PE / L-PEN	$\leq 25$ ns / - / $\leq 25$ ns

General data		
Dimensions W / H / D		17.5 mm / 97 mm / 77.5 mm
Connection data solid / stranded / AWG (IEC) / AWG (UL)		1.5 ... 35 mm <sup>2</sup> / 1.5 ... 25 mm <sup>2</sup> / 15 - 2 / 10 - 2
Temperature range		-40°C ... 80°C
Inflammability class in acc. with UL 94		V-0
Test standards		IEC 61643-11 / EN 61643-11
Remote indication contact		PDT contact
Connection data solid / stranded / AWG (IEC) / AWG (UL)		0.14 ... 1.5 mm <sup>2</sup> / 0.14 ... 1.5 mm <sup>2</sup> / 28 - 16 / 30 - 14
Max. operating voltage		250 V AC / 125 V DC (200 mA DC)
Max. operating current		1.5 A AC / 1 A DC (30 V DC)

#### Ordering data

Description	$U_C$	Type	Order No.	Pcs. / Pkt.
VALVETRAB-MS, varistor-based lightning arrester				
with remote indication contact	75 V AC	VAL-MS-T1/T2 48/12.5/1+0-FM	2801240	1
without remote indication contact	75 V AC	VAL-MS-T1/T2 48/12.5/1+0	2801241	1
	75 V AC			
	75 V AC			

#### Accessories

Replacement plug	VAL-MS-T1/T2 48/12.5 ST	2801242	10
------------------	-------------------------	---------	----

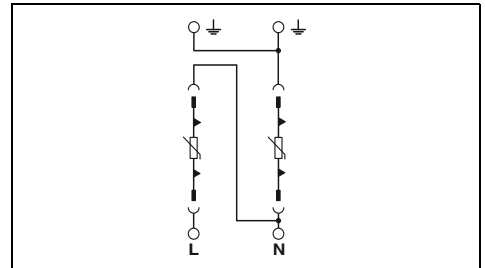

#### Technical data

Electrical data		
IEC test classification		I / II, T1 / T2
Nominal voltage $U_N$		60 V AC $\pm 10\%$ (TN-S)
Maximum continuous operating voltage $U_C$	L-N / N-PE / L-PEN	75 V AC / 75 V AC / -
Impulse discharge curr. $I_{imp}$ (10/350) $\mu$ s	L-N / N-PE / L-PEN	6.25 As / 6.25 As / -
Charge	L-N / N-PE / L-PEN	39 kJ/ $\Omega$ / 39 kJ/ $\Omega$ / -
Specific energy	L-N / N-PE / L-PEN	12.5 kA / 12.5 kA / -
Peak value	L-N / N-PE / L-PEN	12.5 kA / 12.5 kA / -
Nominal discharge current $I_n$ (8/20) $\mu$ s	L-N / N-PE / L-PEN	12.5 kA / 12.5 kA / -
Max. discharge current $I_{max}$ (8/20) $\mu$ s	L-N / N-PE / L-PEN	30 kA / 30 kA / -
Voltage protection level $U_p$	L-N / N-PE / L-PEN	$\leq 0.4$ kV / $\leq 0.4$ kV / -
Short-circuit current rating $I_{SCCR}$	L-N / N-PE / L-PEN	25 kA
Response time $t_A$	L-N / N-PE / L-PEN	$\leq 25$ ns / $\leq 25$ ns / -

General data		
Dimensions W / H / D		35.6 mm / 97 mm / 77.5 mm
Connection data solid / stranded / AWG (IEC) / AWG (UL)		1.5 ... 35 mm <sup>2</sup> / 1.5 ... 25 mm <sup>2</sup> / 15 - 2 / 10 - 2
Temperature range		-40°C ... 80°C
Inflammability class in acc. with UL 94		V-0
Test standards		IEC 61643-11 / EN 61643-11
Remote indication contact		PDT contact
Connection data solid / stranded / AWG (IEC) / AWG (UL)		0.14 ... 1.5 mm <sup>2</sup> / 0.14 ... 1.5 mm <sup>2</sup> / 28 - 16 / 30 - 14
Max. operating voltage		250 V AC / 125 V DC (200 mA DC)
Max. operating current		1.5 A AC / 1 A DC (30 V DC)

#### Ordering data

Description	$U_C$	Type	Order No.	Pcs. / Pkt.
VALVETRAB-MS, varistor-based lightning arrester				
with remote indication contact	75 V AC	VAL-MS-T1/T2 48/12.5/1+1V-FM	2801533	1
without remote indication contact	75 V AC	VAL-MS-T1/T2 48/12.5/1+1V	2801532	1

#### Accessories

Replacement plug	VAL-MS-T1/T2 48/12.5 ST	2801242	10
------------------	-------------------------	---------	----

### Set solution for building installation

- Surge protection set for powerful basic protection
- Coordinated protective devices
- VAL-MS-T1/T2 lightning arrester for installation in the distribution
- Three device protection adapters (type 3) for protecting the power supply
- Two of these are equipped with additional signal line protection (TV/SAT or TAE)
- Cables and adapters are supplied as standard



Set solution with surge protection for TAE and TV-SAT

ERIC

Description
<p><b>Building set</b>, consisting of:</p> <ul style="list-style-type: none"> <li>1 x VAL-MS-T1/T2 (surge arrester),</li> <li>1 x MNT-1D (device protection adapter),</li> <li>1 x MNT-TV-SAT D (device and TV-SAT protective adapter),</li> <li>1 x MNT-TAE D (device and TAE protective adapter),</li> <li>2 x F to TV (IEC) connector adapter,</li> <li>1 x KBL TV-SAT/150, 1 x KBL TV/150,</li> <li>1 x KBL TAE/150 (connecting cable)</li> </ul>

Ordering data		
Type	Order No.	Pcs. / Pkt.
GEB-SET-T1/T2 TAE/TV-SAT	2801022	1

# Surge protection and interference suppression filters

## Surge protection for the power supply

### Type 2 surge arrester VALVETRAB MS 30/40 kA performance class

- Multi-channel type 2 arrester
- Type 2 surge arresters with consistent plug-in design
- Disconnect device on each individual plug
- Optical, mechanical status indication for the individual arresters
- With or without floating remote indication contact
- Mechanical coding of all slots
- Plugs can be checked with CHECKMASTER



5-conductor system; L1, L2, L3, N, PE, supply line supply from below



5-conductor system; L1, L2, L3, N, PE, supply line supply from above

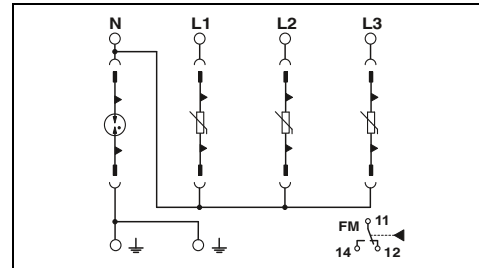
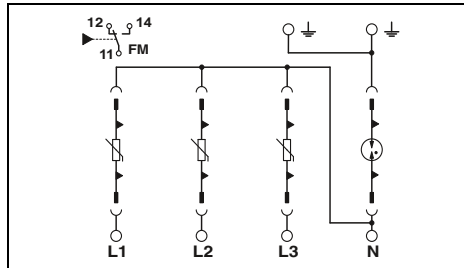

#### Technical data

Electrical data	VAL-MS 230	VAL-MS 320
IEC test classification	II, T2	II, T2
Nominal voltage $U_N$	240/415 V AC (TN-S) / 240/415 V AC (TT)	240/415 V AC (TN-S) / 240/415 V AC (TT)
Maximum continuous operating voltage $U_c$	L-N / N-PE / L-PEN 275 V AC / 260 V AC / -	L-N / N-PE / L-PEN 335 V AC / 260 V AC / -
Nominal discharge current $I_n$ (8/20) $\mu$ s	L-N / N-PE / L-PEN 20 kA / 20 kA / -	L-N / N-PE / L-PEN 20 kA / 20 kA / -
Max. discharge current $I_{max}$ (8/20) $\mu$ s	L-N / N-PE / L-PEN 40 kA / 40 kA / -	L-N / N-PE / L-PEN 40 kA / 40 kA / -
Voltage protection level $U_p$	L-N / N-PE / L-PEN $\leq 1.35$ kV / $\leq 1.5$ kV / -	L-N / N-PE / L-PEN $\leq 1.6$ kV / $\leq 1.5$ kV / -
Short-circuit current rating $I_{SCCR}$	125 A AC (gG)	25 kA 125 A AC (gG)
Max. backup fuse with branch wiring	125 A AC (gG)	125 A AC (gG)
Response time $t_A$	L-N / N-PE / L-PEN $\leq 25$ ns / $\leq 100$ ns / -	L-N / N-PE / L-PEN $\leq 25$ ns / $\leq 100$ ns / -
General data	71 mm / 99 mm / 58 mm	
Dimensions W / H / D	1.5 ... 35 mm <sup>2</sup> / 1.5 ... 25 mm <sup>2</sup> / 15 - 2 / 10 - 2	
Connection data solid / stranded / AWG (IEC) / AWG (UL)	-40°C ... 80°C	
Temperature range	V-0	
Inflammability class in acc. with UL 94	IEC 61643-11 / EN 61643-11	
Test standards	PDT contact	
Remote indication contact	0.14 ... 1.5 mm <sup>2</sup> / 0.14 ... 1.5 mm <sup>2</sup> / 28 - 16 / 30 - 14	
Connection data solid / stranded / AWG (IEC) / AWG (UL)	250 V AC / 30 V DC	
Max. operating voltage	0.75 A AC / 1 A DC	
Max. operating current		

#### Technical data

Electrical data	VAL-MS 320	
IEC test classification	II, T2	
Nominal voltage $U_N$	240/415 V AC (TN-S) / 240/415 V AC (TT)	
Maximum continuous operating voltage $U_c$	L-N / N-PE / L-PEN 335 V AC / 260 V AC / -	
Nominal discharge current $I_n$ (8/20) $\mu$ s	L-N / N-PE / L-PEN 20 kA / 20 kA / -	
Max. discharge current $I_{max}$ (8/20) $\mu$ s	L-N / N-PE / L-PEN 40 kA / 40 kA / -	
Voltage protection level $U_p$	L-N / N-PE / L-PEN $\leq 1.6$ kV / $\leq 1.5$ kV / -	
Short-circuit current rating $I_{SCCR}$	25 kA 125 A AC (gG)	
Max. backup fuse with branch wiring	125 A AC (gG)	
Response time $t_A$	L-N / N-PE / L-PEN $\leq 25$ ns / $\leq 100$ ns / -	
General data	71 mm / 99 mm / 58 mm	
Dimensions W / H / D	1.5 ... 35 mm <sup>2</sup> / 1.5 ... 25 mm <sup>2</sup> / 15 - 2 / 10 - 2	
Connection data solid / stranded / AWG (IEC) / AWG (UL)	-40°C ... 80°C	
Temperature range	V-0	
Inflammability class in acc. with UL 94	IEC 61643-11 / EN 61643-11	
Test standards	PDT contact	
Remote indication contact	0.14 ... 1.5 mm <sup>2</sup> / 0.14 ... 1.5 mm <sup>2</sup> / 28 - 16 / 30 - 14	
Connection data solid / stranded / AWG (IEC) / AWG (UL)	250 V AC / 30 V DC	
Max. operating voltage	0.75 A AC / 1 A DC	
Max. operating current		

#### Ordering data

Description	$I_{max}$	$U_c$
<b>VALVETRAB</b> , multi-position surge arrester combination		
without remote indication contact	40 kA	275 V AC
with remote indication contact	40 kA	275 V AC
without remote indication contact	40 kA	335 V AC
with remote indication contact	40 kA	335 V AC
<b>VALVETRAB MS</b>		
without remote indication contact		
with remote indication contact		

Type	Order No.	Pcs. / Pkt.
VAL-MS 230/3+1	2838209	1
VAL-MS 230/3+1 FM	2838199	1
VAL-MS 320/3+1	2859178	1
VAL-MS 320/3+1/FM	2859181	1

#### Ordering data

Type	Order No.	Pcs. / Pkt.
VAL-MS 320/3+1/FM-UD	2856689	1

#### Accessories

Replacement plug	1L-N/PE	1L-N/PE	1L-N/PE	N-PE
VAL-MS 230 ST				
VAL-MS 320 ST				
F-MS 12 ST				

Type	Order No.	Pcs. / Pkt.
VAL-MS 230 ST	2798844	10
VAL-MS 320 ST	2838843	10
F-MS 12 ST	2817990	10

#### Accessories

Type	Order No.	Pcs. / Pkt.
VAL-MS 320-UD ST	2858315	10
F-MS 12 ST	2817990	10





4-conductor system; L1, L2, L3, PEN



3-conductor system; L, N, PE



3-conductor system; L1, L2, PEN

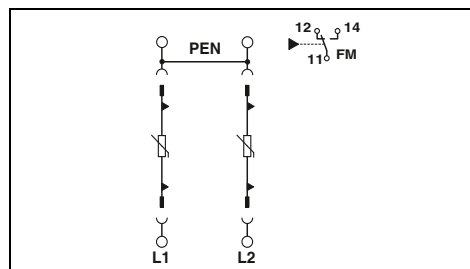
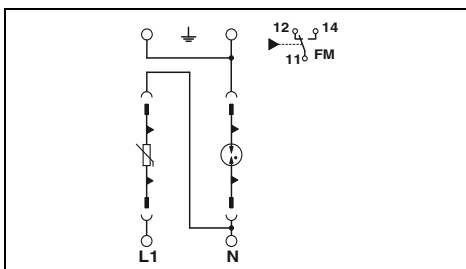
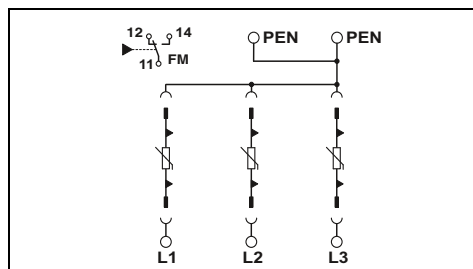

### Technical data

VAL-MS 320	VAL-MS 580
II, T2	II, T2
240/415 V AC (TN-C)	400/690 V AC (TN-C) / 500 V AC (IT)
- / - / 335 V AC	- / - / 580 V AC
- / - / 20 kA	- / - / 15 kA
- / - / 40 kA	- / - / 30 kA
- / - / ≤ 1.5 kV	- / - / ≤ 2.5 kV
125 A AC (gG)	25 kA 125 A AC (gG)
- / - / ≤ 25 ns	- / - / ≤ 25 ns

### Technical data

VAL-MS 230	VAL-MS 320
II, T2	II, T2
240/415 V AC (TN-S) / 240/415 V AC (TT)	240/415 V AC (TN-S) / 240/415 V AC (TT)
275 V AC / 260 V AC / -	335 V AC / 260 V AC / -
20 kA / 20 kA / -	20 kA / 20 kA / -
40 kA / 40 kA / -	40 kA / 40 kA / -
≤ 1.35 kV / ≤ 1.5 kV / -	≤ 1.5 kV / ≤ 1.5 kV / -
125 A AC (gG)	25 kA 125 A AC (gG)
≤ 25 ns / ≤ 100 ns / -	≤ 25 ns / ≤ 100 ns / -

### Technical data

VAL-MS 230
II, T2
240/415 V AC (TN-C)
- / - / 275 V AC
- / - / 20 kA
- / - / 40 kA
- / - / ≤ 1.35 kV
25 kA 125 A AC (gG)
- / - / ≤ 25 ns

53.4 mm / 99 mm / 58 mm  
1.5 ... 35 mm<sup>2</sup> / 1.5 ... 25 mm<sup>2</sup> / 15 - 2 / 10 - 2

-40°C ... 80°C  
V-0

IEC 61643-11 / EN 61643-11

PDT contact

0.14 ... 1.5 mm<sup>2</sup> / 0.14 ... 1.5 mm<sup>2</sup> / 28 - 16 / 30 - 14

250 V AC / 30 V DC  
1.5 A AC / 1 A DC

35.6 mm / 97 mm / 58 mm  
1.5 ... 35 mm<sup>2</sup> / 1.5 ... 25 mm<sup>2</sup> / 15 - 2 / 10 - 2

-40°C ... 80°C  
V-0

IEC 61643-11 / EN 61643-11

PDT contact

0.14 ... 1.5 mm<sup>2</sup> / 0.14 ... 1.5 mm<sup>2</sup> / 28 - 16 / 30 - 14

250 V AC / 30 V DC  
1.5 A AC / 1 A DC

35.6 mm / 97 mm / 58 mm  
1.5 ... 35 mm<sup>2</sup> / 1.5 ... 25 mm<sup>2</sup> / 15 - 2 / 10 - 2

-40°C ... 80°C  
V-0

IEC 61643-11 / EN 61643-11

PDT contact

0.14 ... 1.5 mm<sup>2</sup> / 0.14 ... 1.5 mm<sup>2</sup> / 28 - 16 / 30 - 14

250 V AC / 30 V DC  
1.5 A AC / 1 A DC

### Ordering data

Type	Order No.	Pcs. / Pkt.
VAL-MS 320/3+0	2920230	1
VAL-MS 320/3+0-FM	2920243	1
VAL-MS 580/3+0	2920450	1
VAL-MS 580/3+0-FM	2920447	1

### Ordering data

Type	Order No.	Pcs. / Pkt.
VAL-MS 230/1+1	2804429	1
VAL-MS 230/1+1-FM	2804432	1
VAL-MS 320/1+1	2804380	1
VAL-MS 320/1+1-FM	2804393	1

### Ordering data

Type	Order No.	Pcs. / Pkt.
VAL-MS 230/2+0	2800103	1
VAL-MS 230/2+0-FM	2800102	1

### Accessories

VAL-MS 320 ST	2838843	10
VAL-MS 580-ST	2920434	10

### Accessories

VAL-MS 230 ST	2798844	10
VAL-MS 320 ST	2838843	10
F-MS 12 ST	2817990	10

### Accessories

VAL-MS 230 ST	2798844	10
---------------	---------	----

# Surge protection and interference suppression filters

## Surge protection for the power supply

### Type 2 surge arrester, VALVETRAB MS, free of leakage current

- DIN-rail-mountable protective devices
- Consisting of base element and plug
- Free of leakage current
- Thermal disconnect device for each individual plug
- Optical, mechanical status indication for the individual arresters
- With or without floating remote indication contact
- Mechanical coding of all slots
- Plugs can be checked with CHECKMASTER



5-conductor system; L1, L2, L3, N, PE



4-conductor system; L1, L2, L3, PEN

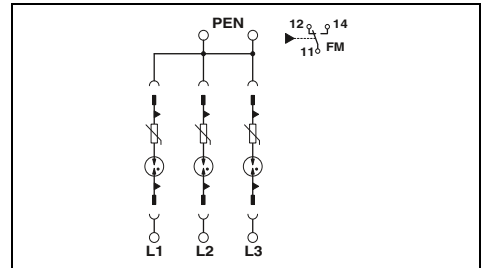
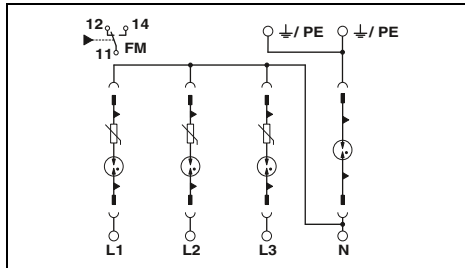

#### Technical data

Electrical data	
IEC test classification	II, T2
Nominal voltage $U_N$	240/415 V AC (TN-S) / 240/415 V AC (TT)
Maximum continuous operating voltage $U_c$	L-N / N-PE / L-PEN 350 V AC / 260 V AC / -
Nominal discharge current $I_n$ (8/20) $\mu$ s	L-N / N-PE / L-PEN 10 kA / 20 kA / -
Max. discharge current $I_{max}$ (8/20) $\mu$ s	L-N / N-PE / L-PEN 20 kA / 40 kA / -
Voltage protection level $U_p$	L-N / N-PE / L-PEN $\leq 1.5$ kV / $\leq 1.5$ kV / -
Short-circuit current rating $I_{SCCR}$	25 kA
Max. backup fuse with branch wiring	125 A AC (gG)
Response time $t_A$	L-N / N-PE / L-PEN $\leq 100$ ns / $\leq 100$ ns / -
General data	
Dimensions W / H / D	71 mm / 99 mm / 58 mm
Connection data solid / stranded / AWG (IEC) / AWG (UL)	1.5 ... 35 mm <sup>2</sup> / 1.5 ... 25 mm <sup>2</sup> / 15 - 2 / 10 - 2
Temperature range	-40°C ... 80°C
Inflammability class in acc. with UL 94	V-0
Test standards	IEC 61643-11 / EN 61643-11
Remote indication contact	PDT contact
Connection data solid / stranded / AWG (IEC) / AWG (UL)	0.14 ... 1.5 mm <sup>2</sup> / 0.14 ... 1.5 mm <sup>2</sup> / 28 - 16 / 30 - 14
Max. operating voltage	250 V AC / 30 V DC
Max. operating current	0.75 A AC / 1 A DC

#### Technical data

Electrical data	
IEC test classification	II, T2
Nominal voltage $U_N$	240/415 V AC (TN-C) / 230 V AC (IT)
Maximum continuous operating voltage $U_c$	- / - / 350 V AC
Nominal discharge current $I_n$ (8/20) $\mu$ s	- / - / 10 kA
Max. discharge current $I_{max}$ (8/20) $\mu$ s	- / - / 20 kA
Voltage protection level $U_p$	- / - / $\leq 1.5$ kV
Short-circuit current rating $I_{SCCR}$	25 kA
Max. backup fuse with branch wiring	125 A AC (gG)
Response time $t_A$	- / - / $\leq 100$ ns
General data	
Dimensions W / H / D	53.4 mm / 99 mm / 58 mm
Connection data solid / stranded / AWG (IEC) / AWG (UL)	1.5 ... 35 mm <sup>2</sup> / 1.5 ... 25 mm <sup>2</sup> / 15 - 2 / 10 - 2
Temperature range	-40°C ... 80°C
Inflammability class in acc. with UL 94	V-0
Test standards	IEC 61643-11 / EN 61643-11
Remote indication contact	PDT contact
Connection data solid / stranded / AWG (IEC) / AWG (UL)	0.14 ... 1.5 mm <sup>2</sup> / 0.14 ... 1.5 mm <sup>2</sup> / 28 - 16 / 30 - 14
Max. operating voltage	250 V AC / 30 V DC
Max. operating current	1.5 A AC / 1 A DC

#### Ordering data

Description	<b>VALVETRAB MS</b> with remote indication contact without remote indication contact
-------------	--------------------------------------------------------------------------------------------

Type	Order No.	Pcs. / Pkt.
VAL-MS 350VF/3+1-FM	2858632	1
VAL-MS 350 VF/3+1	2858755	1

#### Ordering data

Type	Order No.	Pcs. / Pkt.
VAL-MS 350 VF/3+0-FM	2901862	1
VAL-MS 350 VF/3+0	2901861	1

#### Accessories

Replacement plug	1L-N/PE N-PE
------------------	-----------------

Type	Order No.	Pcs. / Pkt.
VAL-MS 350 VF ST	2856595	10
F-MS 12 ST	2817990	10

#### Accessories

Type	Order No.	Pcs. / Pkt.
VAL-MS 350 VF ST	2856595	10



3-conductor system; L, N, PE



2-conductor system; L, N/PEN

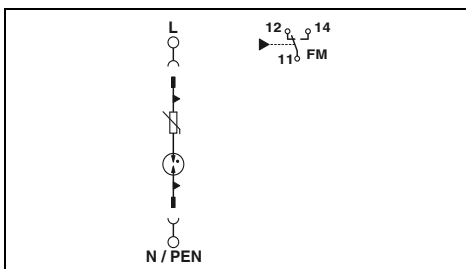
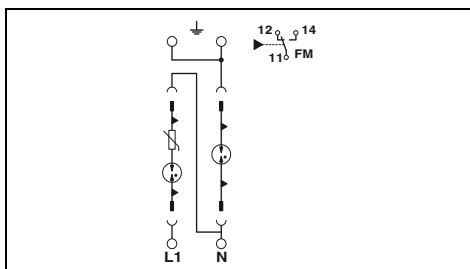

### Technical data

II, T2  
240/415 V AC (TN-S) /  
240/415 V AC (TT)

350 V AC / 260 V AC / -

10 kA / 20 kA / -

20 kA / 40 kA / -

≤ 1.5 kV / ≤ 1.5 kV / -  
25 kA  
125 A AC (gG)

≤ 100 ns / ≤ 100 ns / -

35.6 mm / 97 mm / 58 mm  
1.5 ... 35 mm<sup>2</sup> / 1.5 ... 25 mm<sup>2</sup> / 15 - 2 / 10 - 2

-40°C ... 80°C

V-0

IEC 61643-11 / EN 61643-11

PDT contact

0.14 ... 1.5 mm<sup>2</sup> / 0.14 ... 1.5 mm<sup>2</sup> / 28 - 16 / 30 - 14

250 V AC / 30 V DC

1.5 A AC / 1 A DC

### Technical data

II, T2  
240/415 V AC (TN) / 240/415 V AC (TT) /  
230 V AC (IT)

350 V AC / - / 350 V AC

10 kA / - / 10 kA

20 kA / - / 20 kA

≤ 1.5 kV / - / ≤ 1.5 kV  
25 kA  
125 A AC (gG)

≤ 100 ns / - / ≤ 100 ns

17.6 mm / 97 mm / 58 mm  
1.5 ... 35 mm<sup>2</sup> / 1.5 ... 25 mm<sup>2</sup> / 15 - 2 / 10 - 2

-40°C ... 80°C

V-0

IEC 61643-11 / EN 61643-11

PDT contact

0.14 ... 1.5 mm<sup>2</sup> / 0.14 ... 1.5 mm<sup>2</sup> / 28 - 16 / 30 - 14

250 V AC / 30 V DC

1 A AC / 1 A DC

### Ordering data

Type	Order No.	Pcs. / Pkt.
VAL-MS 350 VF/1+1-FM	2902577	1
VAL-MS 350 VF/1+1	2901865	1

### Accessories

VAL-MS 350 VF ST	2856595	10
F-MS 12 ST	2817990	10

### Ordering data

Type	Order No.	Pcs. / Pkt.
VAL-MS 350 VF/FM	2856579	1
VAL-MS 350VF	2856582	1

### Accessories

VAL-MS 350 VF ST	2856595	10
------------------	---------	----

# Surge protection and interference suppression filters

## Surge protection for the power supply

### Surge protection for special applications

- Consistent plug-in design
- Also suitable for industry solutions, e.g., in the rail and telecommunications sectors
- Thermal disconnect device for each individual plug
- Optical, mechanical status indication for the individual arresters
- With or without floating remote indication contact
- Mechanical coding of all slots
- Plugs can be checked with CHECKMASTER

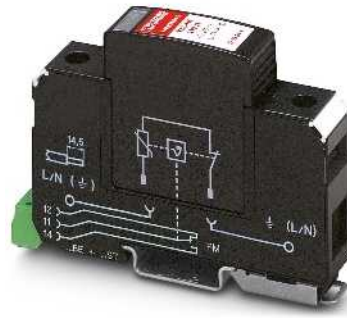

2-conductor system; L, N/PEN

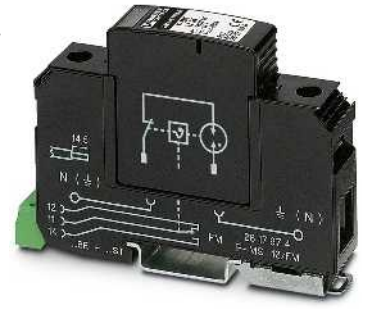

Spark gap, N-PE

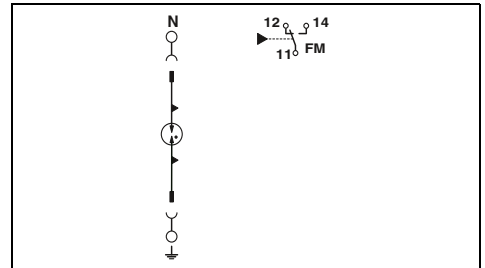
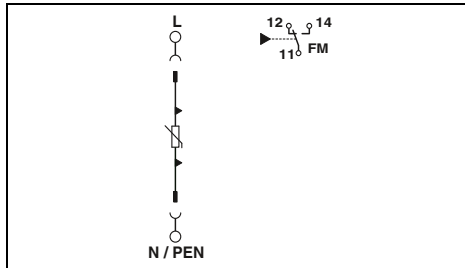

#### Technical data

Electrical data	... 60AC	... 230AC
IEC test classification	II, T2	II, T2
Nominal voltage $U_N$	60 V AC (TN)	240/415 V AC (TN) / 240/415 V AC (TT)
Maximum continuous operating voltage $U_c$	L-N / N-PE / L-PEN 75 V AC / - / 75 V AC	275 V AC / - / 275 V AC
Nominal discharge current $I_n$ (8/20) $\mu$ s	L-N / N-PE / L-PEN 15 kA / - / 15 kA	20 kA / - / 20 kA
Max. discharge current $I_{max}$ (8/20) $\mu$ s	L-N / N-PE / L-PEN 40 kA / - / 40 kA	40 kA / - / 40 kA
Voltage protection level $U_p$	L-N / N-PE / L-PEN $\leq 0.55$ kV / - / $\leq 0.55$ kV	$\leq 1.35$ kV / - / $\leq 1.35$ kV
Short-circuit current rating $I_{SCCR}$	125 A AC (gG)	25 kA
Max. backup fuse with branch wiring	125 A AC (gG)	125 A AC (gG)
Response time $t_A$	L-N / N-PE / L-PEN $\leq 25$ ns / - / $\leq 25$ ns	$\leq 25$ ns / - / $\leq 25$ ns
General data		
Dimensions W / H / D	17.6 mm / 97 mm / 44 mm	
Connection data solid / stranded / AWG (IEC) / AWG (UL)	1.5 ... 35 mm <sup>2</sup> / 1.5 ... 25 mm <sup>2</sup> / 15 - 2 / 10 - 2	
Temperature range	-40°C ... 80°C	
Inflammability class in acc. with UL 94	V-0	
Test standards	IEC 61643-11 / EN 61643-11	
Remote indication contact	PDT contact	
Connection data solid / stranded / AWG (IEC) / AWG (UL)	0.14 ... 1.5 mm <sup>2</sup> / 0.14 ... 1.5 mm <sup>2</sup> / 28 - 16 / 30 - 14	
Max. operating voltage	250 V AC / 30 V DC	
Max. operating current	1 A AC / 1 A DC	

#### Technical data

Electrical data	F-MS 12
IEC test classification	II, T2
Nominal voltage $U_N$	240/415 V AC (TN - only N-PE) / 240/415 V AC (TT - only N-PE)
Maximum continuous operating voltage $U_c$	- / 260 V AC / -
Nominal discharge current $I_n$ (8/20) $\mu$ s	- / 20 kA / -
Max. discharge current $I_{max}$ (8/20) $\mu$ s	- / 40 kA / -
Voltage protection level $U_p$	- / $\leq 1.5$ kV / -
Short-circuit current rating $I_{SCCR}$	-
Max. backup fuse with branch wiring	-
Response time $t_A$	- / $\leq 100$ ns / -
General data	
Dimensions W / H / D	17.6 mm / 97 mm / 58 mm
Connection data solid / stranded / AWG (IEC) / AWG (UL)	1.5 ... 35 mm <sup>2</sup> / 1.5 ... 25 mm <sup>2</sup> / 15 - 2 / 10 - 2
Temperature range	-40°C ... 80°C
Inflammability class in acc. with UL 94	V-0
Test standards	IEC 61643-11 / EN 61643-11
Remote indication contact	PDT contact
Connection data solid / stranded / AWG (IEC) / AWG (UL)	0.14 ... 1.5 mm <sup>2</sup> / 0.14 ... 1.5 mm <sup>2</sup> / 28 - 16 / 30 - 14
Max. operating voltage	250 V AC / 30 V DC
Max. operating current	1 A AC / 1 A DC

#### Ordering data

Description	Type	Order No.	Pcs. / Pkt.
<b>VALVETRAB MS</b>			
with remote indication contact	VAL-MS 60/FM	2868033	1
without remote indication contact	VAL-MS 60	2868020	1
with remote indication contact	VAL-MS 230/FM	2839130	1
without remote indication contact	VAL-MS 230	2839127	1

#### Ordering data

Description	Type	Order No.	Pcs. / Pkt.
	F-MS 12/FM	2817974	1
	F-MS 12	2817987	1

#### Accessories

Replacement plug	Type	Order No.	Pcs. / Pkt.
1L-N/PE	VAL-MS 60 ST	2807573	10
1L-N/PE	VAL-MS 230 ST	2798844	10

#### Accessories

Replacement plug	Type	Order No.	Pcs. / Pkt.
	F-MS 12 ST	2817990	10

### Type 2 surge protection plug for VAL-MS base elements

- Thermal disconnect device for each individual plug
- Optical, mechanical status indication for all protective plugs
- Plugs can be checked with CHECKMASTER

**Notes:**

Please follow the installation instructions. These are provided with the packaging documentation or can be downloaded from the corresponding product page online at [phoenixcontact.net/products](http://phoenixcontact.net/products).

You can find a list of all possible combination options and safety notes in the download area for the corresponding replacement plug at [phoenixcontact.net/products](http://phoenixcontact.net/products).



Plug, 1-pos., L-N/L-PEN

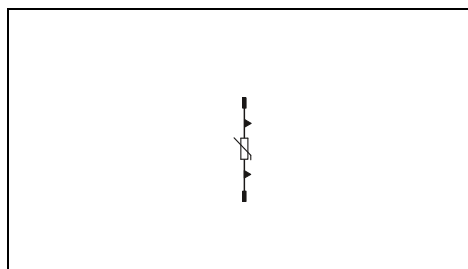

Electrical data
IEC test classification
Nominal voltage $U_N$
Maximum continuous operating voltage $U_C$
Nominal discharge current $I_n$ (8/20) $\mu$ s
Max. discharge current $I_{max}$ (8/20) $\mu$ s
Residual voltage at 5 kA
Protection level $U_p$
Short-circuit current rating $I_{SCCR}$
Max. backup fuse with branch wiring
Response time $t_A$
General data
Dimensions W / H / D
Temperature range
Inflammability class in acc. with UL 94
Test standards

Technical data			
... 120 ST	... 230 IT ST	... 400 ST	... 500 ST
II, T2	II, T2	II, T2	II, T2
120/208 V AC (TN)	240/415 V AC (TN) / 240/415 V AC (TT) / 230 V AC (IT)	240/415 V AC (TN) / 240/415 V AC (TT) / 230 V AC (IT)	400/690 V AC (TN) / 500 V AC (IT)
150 V AC	385 V AC	440 V AC	600 V AC
20 kA	20 kA	20 kA	15 kA
40 kA	40 kA	40 kA	30 kA
$\leq 0.9$ kV	$\leq 1.8$ kV	$\leq 2.2$ kV	$\leq 2.7$ kV
		25 kA	
125 A AC (gG)	125 A AC (gG)	125 A AC (gG)	125 A AC (gG)
$\leq 25$ ns	$\leq 25$ ns	$\leq 25$ ns	$\leq 25$ ns
17.5 mm / 52.4 mm / 55.3 mm			
-40°C ... 80°C			
V-0			
IEC 61643-11 / EN 61643-11			

Description
VALVETRAB surge protection plug

Ordering data		
Type	Order No.	Pcs. / Pkt.
VAL-MS 120 ST	2807586	10
VAL-MS 230 IT ST	2807599	10
VAL-MS 400 ST	2816399	10
VAL-MS 500 ST	2807609	10

VALVETRAB, base element for individual assembly with VAL-MS...ST	
with remote indication contact	3L-PEN
without remote indication contact	3L-PEN
with remote indication contact	2L-PEN

Accessories		
VAL-MS/3+0-BE/FM	2881803	1
VAL-MS/3+0-BE	2881816	1

# Surge protection and interference suppression filters

## Surge protection for the power supply

### Type 2 surge protection plug for VAL-MS base elements

- Specifically for use in American applications
- 1-pos.
- Thermal disconnect device for each individual plug
- Optical, mechanical status indication for all protective plugs
- Plugs can be checked with CHECKMASTER



Single-pos.



Single-pos.

**Notes:**  
Please follow the installation instructions. These are provided with the packaging documentation or can be downloaded from the corresponding product page online at phoenixcontact.net/products.  
You can find a list of all possible combination options and safety notes in the download area for the corresponding replacement plug at phoenixcontact.net/products.

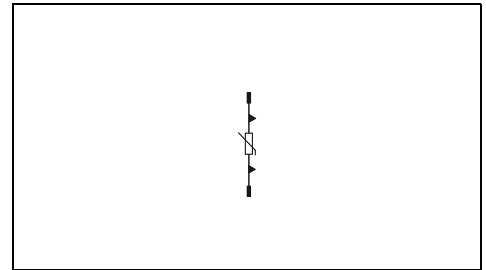
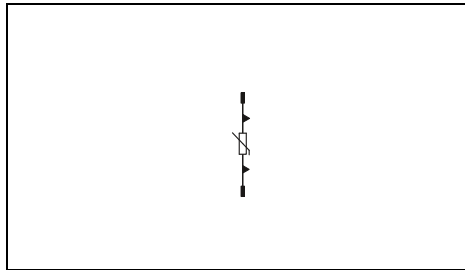

Electrical data	
IEC test classification	II, T2
Nominal voltage $U_N$	60 V AC
Maximum continuous operating voltage $U_C$	75 V AC
Nominal discharge current $I_n$ (8/20) $\mu$ s	15 kA
Max. discharge current $I_{max}$ (8/20) $\mu$ s	40 kA
Protection level $U_p$	$\leq 0.55$ kV
Short-circuit current rating $I_{SCCR}$	25 kA
Max. backup fuse with branch wiring	125 A AC (gG)
Response time $t_d$	$\leq 25$ ns
General data	
Dimensions W / H / D	17.5 mm / 52.4 mm / 55.3 mm
Temperature range	-40°C ... 80°C
Inflammability class in acc. with UL 94	V-0
Test standards	IEC 61643-11 / EN 61643-11

Technical data		
... 60 ST	... 120 ST	... 240 ST
II, T2	II, T2	II, T2
60 V AC	120 V AC	240 V AC
75 V AC	175 V AC	275 V AC
15 kA	20 kA	20 kA
40 kA	40 kA	40 kA
$\leq 0.55$ kV	$\leq 0.9$ kV	$\leq 1.35$ kV
	25 kA	
125 A AC (gG)	125 A AC (gG)	125 A AC (gG)
$\leq 25$ ns	$\leq 25$ ns	$\leq 25$ ns
	17.5 mm / 52.4 mm / 55.3 mm	
	-40°C ... 80°C	
	V-0	
	IEC 61643-11 / EN 61643-11	

Technical data		
... 277 ST	... 347 ST	... 480 ST
II, T2	II, T2	II, T2
277 V AC	347 V AC	480 V AC
385 V AC	440 V AC	580 V AC
20 kA	20 kA	15 kA
40 kA	40 kA	30 kA
$\leq 1.8$ kV	$\leq 2.2$ kV	$\leq 2.5$ kV
	25 kA	
125 A AC (gG)	125 A AC (gG)	125 A AC (gG)
$\leq 25$ ns	$\leq 25$ ns	$\leq 25$ ns
	17.5 mm / 52.4 mm / 55.3 mm	
	-40°C ... 80°C	
	V-0	
	IEC 61643-11 / EN 61643-11	

Description
VALVETRAB surge protection plug

Ordering data		
Type	Order No.	Pcs. / Pkt.
VAL-US 60 ST	2800738	10
VAL-US 120 ST	2800739	10
VAL-US 240 ST	2800740	10

Ordering data		
Type	Order No.	Pcs. / Pkt.
VAL-US 277 ST	2800741	10
VAL-US 347 ST	2800742	10
VAL-US 480 ST	2800743	10

VALVETRAB, base element for individual assembly with VAL-MS...ST	
with remote indication contact	
without remote indication contact	
with remote indication contact	2L-PEN
without remote indication contact	2L-PEN
with remote indication contact	3L-PEN
without remote indication contact	3L-PEN
with remote indication contact	4L-PEN

Accessories		
Accessories	Order No.	Pcs. / Pkt.
VAL-MS BE/FM	2817738	10
VAL-MS BE	2817741	10
VAL-MS/2+0-BE/FM	2805321	1
VAL-MS/2+0-BE	2804584	1
VAL-MS/3+0-BE/FM	2881803	1
VAL-MS/3+0-BE	2881816	1
VAL-MS/4+0-BE/FM RN.	2906484	1

Accessories		
Accessories	Order No.	Pcs. / Pkt.
VAL-MS BE/FM	2817738	10
VAL-MS BE	2817741	10
VAL-MS/2+0-BE/FM	2805321	1
VAL-MS/2+0-BE	2804584	1
VAL-MS/3+0-BE/FM	2881803	1
VAL-MS/3+0-BE	2881816	1
VAL-MS/4+0-BE/FM RN.	2906484	1



# Surge protection and interference suppression filters

## Surge protection for the power supply

### Surge protection for use in wind power plants

- For power supplies with higher supply voltages
- Other solutions for power supplies  $U_N \geq 400$  V available on request
- Consistent plug-in design
- Thermal disconnect device for each individual plug
- Optical, mechanical status indication for the individual arresters
- With or without floating remote indication contact
- Mechanical coding of all slots
- Plugs can be checked with CHECKMASTER



Free of leakage current, for nominal voltages up to 690 V AC, e.g., rotor protection for wind power plants

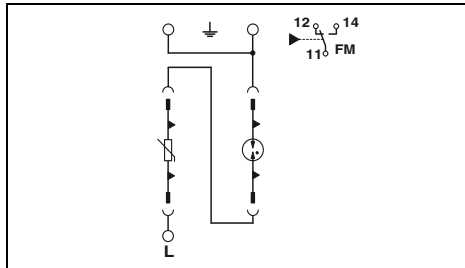

#### Technical data

Electrical data		II, T2
IEC test classification		400/690 V AC (TN-C) / 690 V AC (IT)
Nominal voltage $U_N$		
Maximum continuous operating voltage $U_c$	L-N / N-PE / L-PEN	- / - / 800 V AC
Nominal discharge current $I_n$ (8/20) $\mu$ s	L-N / N-PE / L-PEN	- / - / 15 kA
Max. discharge current $I_{max}$ (8/20) $\mu$ s	L-N / N-PE / L-PEN	- / - / 30 kA
Voltage protection level $U_p$	L-N / N-PE / L-PEN	- / - / $\leq 5$ kV
Short-circuit current rating $I_{SCCR}$		25 kA
Max. backup fuse with branch wiring		100 A AC (gG)
Response time $t_A$	L-N / N-PE / L-PEN	- / - / $\leq 100$ ns

General data		35.6 mm / 99 mm / 58 mm
Dimensions W / H / D		
Connection data solid / stranded / AWG (IEC) / AWG (UL)		1.5 ... 35 mm <sup>2</sup> / 1.5 ... 25 mm <sup>2</sup> / 15 - 2 / -
Temperature range		-40°C ... 80°C
Inflammability class in acc. with UL 94		V-0
Test standards		IEC 61643-11 / EN 61643-11
Remote indication contact		PDT contact
Connection data solid / stranded / AWG (IEC) / AWG (UL)		0.14 ... 1.5 mm <sup>2</sup> / 0.14 ... 1.5 mm <sup>2</sup> / 28 - 16 / -
Max. operating voltage		250 V AC / 30 V DC
Max. operating current		1.5 A AC / 1 A DC

#### Ordering data

Description	Type	Order No.	Pcs. / Pkt.
VALVETRAB MS, for mounting on NS 35 with remote indication contact	VAL-MS 800/30 VF/FM	2805402	1
without remote indication contact			

#### Accessories

Replacement plug	Type	Order No.	Pcs. / Pkt.
1L-N/PE	VAL-MS 750/30-ST	2920256	10
	F-MS 2200/30 ST	2805392	10



4-conductor system; L1, L2, L3, PEN (554/960 V TN-C system)

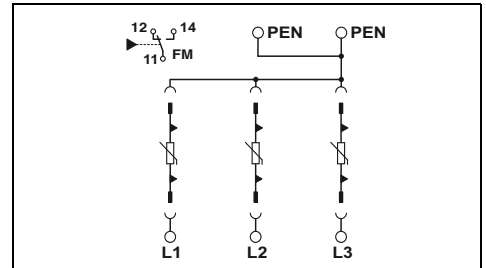

#### Technical data

Electrical data		II, T2
IEC test classification		554/960 V AC (TN-C) / 690 V AC (IT)
Nominal voltage $U_N$		
Maximum continuous operating voltage $U_c$	L-N / N-PE / L-PEN	- / - / 760 V AC
Nominal discharge current $I_n$ (8/20) $\mu$ s	L-N / N-PE / L-PEN	- / - / 15 kA
Max. discharge current $I_{max}$ (8/20) $\mu$ s	L-N / N-PE / L-PEN	- / - / 30 kA
Voltage protection level $U_p$	L-N / N-PE / L-PEN	- / - / $\leq 2.9$ kV
Short-circuit current rating $I_{SCCR}$		25 kA
Max. backup fuse with branch wiring		100 A AC (gG)
Response time $t_A$	L-N / N-PE / L-PEN	- / - / $\leq 25$ ns

General data		53.4 mm / 99 mm / 58 mm
Dimensions W / H / D		
Connection data solid / stranded / AWG (IEC) / AWG (UL)		1.5 ... 35 mm <sup>2</sup> / 1.5 ... 25 mm <sup>2</sup> / 15 - 2 / 10 - 2
Temperature range		-40°C ... 80°C
Inflammability class in acc. with UL 94		V-0
Test standards		IEC 61643-11 / EN 61643-11
Remote indication contact		PDT contact
Connection data solid / stranded / AWG (IEC) / AWG (UL)		0.14 ... 1.5 mm <sup>2</sup> / 0.14 ... 1.5 mm <sup>2</sup> / 28 - 16 / 30 - 14
Max. operating voltage		250 V AC / 30 V DC
Max. operating current		1.5 A AC / 1 A DC

#### Ordering data

Description	Type	Order No.	Pcs. / Pkt.
VAL-MS 750/30/3+0-FM	VAL-MS 750/30/3+0-FM	2920272	1
VAL-MS 750/30/3+0	VAL-MS 750/30/3+0	2920269	1

#### Accessories

Replacement plug	Type	Order No.	Pcs. / Pkt.
1L-N/PE	VAL-MS 750/30-ST	2920256	10



### Type 2 surge arrester VALVETRAB MS 65/80 kA performance class

- Multi-channel type 2 arrester
- Type 2 surge arresters with consistent plug-in design
- Secure hold of plugs in the event of strong vibrations thanks to new latching
- Disconnect device on each individual plug
- Optical, mechanical status indication for the individual arresters
- With or without floating remote indication contact
- Mechanical coding of all slots
- Plugs can be checked with CHECKMASTER



5-conductor system; L1, L2, L3, N, PE



4-conductor system; L1, L2, L3, PEN

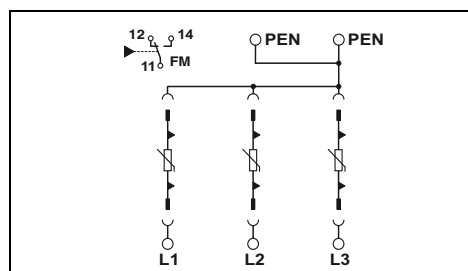
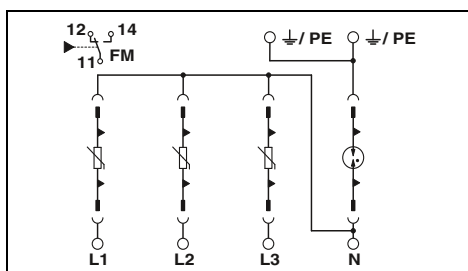

#### Technical data

Electrical data	.. 385/65	.. 385/80
IEC test classification	II, T2	II, T2
Nominal voltage $U_N$	240/415 V AC (TN-S) / 240/415 V AC (TT)	240/415 V AC (TN-S) / 240/415 V AC (TT)
Maximum continuous operating voltage $U_C$	L-N / N-PE / L-PEN	385 V AC / 264 V AC / -
Nominal discharge current $I_n$ (8/20) $\mu$ s	L-N / N-PE / L-PEN	30 kA / 40 kA / -
Max. discharge current $I_{max}$ (8/20) $\mu$ s	L-N / N-PE / L-PEN	65 kA / 80 kA / -
Voltage protection level $U_p$	L-N / N-PE / L-PEN	$\leq 1.8$ kV / $\leq 1.7$ kV / -
Short-circuit current rating $I_{SCCR}$	L-N / N-PE / L-PEN	$\leq 2$ kV / $\leq 1.7$ kV / -
Response time $t_A$	L-N / N-PE / L-PEN	$\leq 25$ ns / $\leq 100$ ns / -
General data	71.2 mm / 99 mm / 77.5 mm	
Dimensions W / H / D	1.5 ... 35 mm <sup>2</sup> / 1.5 ... 25 mm <sup>2</sup> / - / -	
Connection data solid / stranded / AWG (IEC) / AWG (UL)	-40°C ... 80°C	
Temperature range	V-0	
Inflammability class in acc. with UL 94	IEC 61643-11 / EN 61643-11	
Test standards	PDT contact	
Remote indication contact	0.14 ... 1.5 mm <sup>2</sup> / 0.14 ... 1.5 mm <sup>2</sup> / 28 - 16 / -	
Connection data solid / stranded / AWG (IEC) / AWG (UL)	250 V AC / 30 V DC	
Max. operating voltage	1.5 A AC / 1 A DC	
Max. operating current		

#### Technical data

Electrical data	.. 385/65	.. 385/80
IEC test classification	II, T2	II, T2
Nominal voltage $U_N$	240/415 V AC (TN-C)	240/415 V AC (TN-C)
Maximum continuous operating voltage $U_C$	- / - / 385 V AC	- / - / 385 V AC
Nominal discharge current $I_n$ (8/20) $\mu$ s	- / - / 30 kA	- / - / 40 kA
Max. discharge current $I_{max}$ (8/20) $\mu$ s	- / - / 65 kA	- / - / 80 kA
Voltage protection level $U_p$	- / - / $\leq 1.8$ kV	- / - / $\leq 2$ kV
Short-circuit current rating $I_{SCCR}$	- / - / $\leq 25$ ns	- / - / $\leq 25$ ns
Response time $t_A$	- / - / $\leq 25$ ns	- / - / $\leq 25$ ns
General data	53.4 mm / 99 mm / 77.5 mm	
Dimensions W / H / D	1.5 ... 35 mm <sup>2</sup> / 1.5 ... 25 mm <sup>2</sup> / - / -	
Connection data solid / stranded / AWG (IEC) / AWG (UL)	-40°C ... 80°C	
Temperature range	V-0	
Inflammability class in acc. with UL 94	IEC 61643-11 / EN 61643-11	
Test standards	PDT contact	
Remote indication contact	0.14 ... 1.5 mm <sup>2</sup> / 0.14 ... 1.5 mm <sup>2</sup> / 28 - 16 / -	
Connection data solid / stranded / AWG (IEC) / AWG (UL)	250 V AC / 30 V DC	
Max. operating voltage	1.5 A AC / 1 A DC	
Max. operating current		

#### Ordering data

Type	Order No.	Pcs. / Pkt.
VAL-MS 385/65/3+1-FM	2920887	1
VAL-MS 385/65/3+1	2920890	1
VAL-MS 385/80/3+1-FM	2920968	1
VAL-MS 385/80/3+1	2920971	1

#### Ordering data

Type	Order No.	Pcs. / Pkt.
VAL-MS 385/65/3+0-FM	2921006	1
VAL-MS 385/65/3+0	2921019	1
VAL-MS 385/80/3+0-FM	2921080	1
VAL-MS 385/80/3+0	2921093	1

#### Accessories

Accessories	Order No.	Pcs. / Pkt.
VAL-MS 385/65 ST	2920308	10
VAL-MS 385/80 ST	2920353	10
F-MS 80 ST	2921307	10

#### Accessories

Accessories	Order No.	Pcs. / Pkt.
VAL-MS 385/65 ST	2920308	10
VAL-MS 385/80 ST	2920353	10

Description	$I_{max}$	$U_C$
<b>VALVETRAB MS</b>		
with remote indication contact	65 kA	385 V AC
without remote indication contact	65 kA	385 V AC
<b>VALVETRAB MS</b>		
with remote indication contact	80 kA	385 V AC
without remote indication contact	80 kA	385 V AC

Replacement plug	For VAL-MS 385/65...	For VAL-MS 385/80...
	1L-N/PE	1L-N/PE
		N-PE

# Surge protection and interference suppression filters

## Surge protection for the power supply

### Type 2 surge arrester for LED applications

- Universal use for street, tunnel or object lighting
- Flexible installation
- Fixed via integrated elongated holes
- Compact design
- Optical status indicator
- Connection in branch or through wiring
- Double or reinforced insulation



For insulation class I



For insulation class II

Total width 36.5 mm

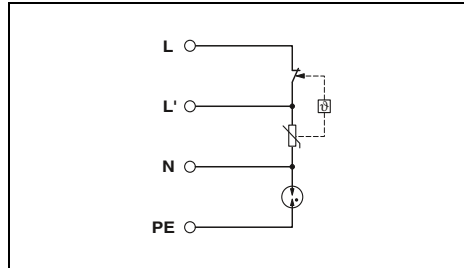

#### Technical data

Electrical data	
IEC test classification/EN type	
Nominal voltage $U_N$	II / III / T2 / T3
Maximum continuous operating voltage $U_c$	277 V AC
Nominal discharge current $I_n$ (8/20) $\mu$ s	L-N / N-PE 320 V AC / 264 V AC
Max. discharge current $I_{max}$ (8/20) $\mu$ s	L-N / N-PE 5 kA / 10 kA
Combination wave $U_{OC}$	L-N / N-PE 10 kA / 20 kA
Voltage protection level $U_p$	L-N / N-PE 10 kV / 20 kV
Response time $t_A$	L-N / N-PE $\leq 1.5$ kV / $\leq 1.5$ kV
Max. backup fuse in acc. with IEC	L-N / N-PE $\leq 25$ ns / $\leq 100$ ns
General data	16 A AC (gG)
Dimensions W / H / D	36.5 mm / 56 mm / 34 mm
Connection data solid / stranded / AWG	2 ... 2.5 mm <sup>2</sup> / 0.2 ... 4 mm <sup>2</sup> / -
Temperature range	-40°C ... 80°C
Inflammability class in acc. with UL 94	V-0
Test standards	IEC 61643-11 / EN 61643-11

Total width 36.5 mm

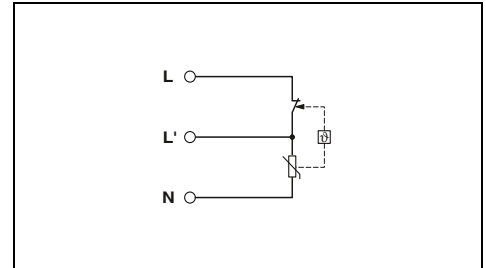

#### Technical data

Electrical data	
IEC test classification/EN type	
Nominal voltage $U_N$	II / III / T2 / T3
Maximum continuous operating voltage $U_c$	277 V AC
Nominal discharge current $I_n$ (8/20) $\mu$ s	L-N / N-PE 320 V AC / 264 V AC
Max. discharge current $I_{max}$ (8/20) $\mu$ s	L-N / N-PE 5 kA / 10 kA
Combination wave $U_{OC}$	L-N / N-PE 10 kA / 20 kA
Voltage protection level $U_p$	L-N / N-PE 10 kV / 20 kV
Response time $t_A$	L-N / N-PE $\leq 1.5$ kV / -
Max. backup fuse in acc. with IEC	L-N / N-PE $\leq 25$ ns / -
General data	16 A AC (gG)
Dimensions W / H / D	36.5 mm / 56 mm / 34 mm
Connection data solid / stranded / AWG	2 ... 2.5 mm <sup>2</sup> / 0.2 ... 4 mm <sup>2</sup> / -
Temperature range	-40°C ... 80°C
Inflammability class in acc. with UL 94	V-0
Test standards	IEC 61643-11 / EN 61643-11

#### Ordering data

Description	<b>BLOCKTRAB</b> , for universal mounting
-------------	-------------------------------------------

Type	Order No.	Pcs. / Pkt.
BLT-T2-1S-320-UT	2906101	1

#### Ordering data

Type	Order No.	Pcs. / Pkt.
BLT-T2-320-UT	2906100	1

### Type 2 surge arrester with RCD Combi-RCD

- For 5-conductor systems; L1, L2, L3, N, PE
- Combination of type 2 surge arrester and RCD residual current circuit breaker
- Personal protection and device protection in a single device
- Type 2 surge arresters with consistent plug-in design
- Disconnect device on each individual plug
- Optical, mechanical status indication for all protective plugs
- Residual current circuit breaker is not triggered by magnetic influences caused by discharge currents in the type 2 arrester
- Plugs can be checked with CHECKMASTER



With selective RCD residual current circuit breaker, 300 mA



With selective RCD residual current circuit breaker, 30 mA

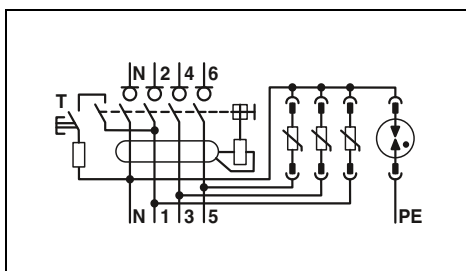

#### Technical data

Electrical data	
IEC test classification	II, T2
Nominal voltage $U_N$	240/415 V AC (TN-S) / 240/415 V AC (TT)
Maximum continuous operating voltage $U_C$	L-N / N-PE / L-PEN 350 V AC / 264 V AC / -
Nominal discharge current $I_n$ (8/20) $\mu$ s	L-N / N-PE / L-PEN 20 kA / 20 kA / -
Max. discharge current $I_{max}$ (8/20) $\mu$ s	L-N / N-PE / L-PEN 30 kA / 30 kA / -
Voltage protection level $U_p$	L-N / N-PE / L-PEN $\leq 2$ kV / $\leq 2$ kV / -
Short-circuit current rating $I_{SCCR}$	10 kA
Max. backup fuse with branch wiring	63 A AC (MCB)
Response time $t_A$	L-N / N-PE / L-PEN $\leq 25$ ns / $\leq 100$ ns / -

General data	
Dimensions W / H / D	121 mm / 90 mm / 76 mm
Connection data solid / stranded / AWG (IEC) / AWG (UL)	4 ... 25 mm <sup>2</sup> / 4 ... 25 mm <sup>2</sup> / - / -
Temperature range	-25°C ... 40°C
Inflammability class in acc. with UL 94	V-0
Test standards	IEC 61643-11 / EN 61643-11 / EN 61008-1 / IEC 60947-1 / IEC 60947-3

RCD data	
Tripping characteristic	A (selective)
Nominal load current $I_L$	40 A
Rated residual current	300 mA
Rated making and breaking capacity $I_m$	1.5 kA
Rated residual making and breaking capacity $I_{\Delta m}$	2.5 kA
Surge withstand capability	6 kV (1.2/50 $\mu$ s)
Immunity to short-circuiting $I_{nc}$	10 kA
Tripping time for $I_{\Delta n}$	$\leq 300$ ms
Tripping time for $5xI_{\Delta n}$	$\leq 40$ ms
Cycles, max.	20000
Utilization category	AC 23 A

#### Ordering data

Description	Type	Order No.	Pcs. / Pkt.
VALVETRAB compact with RCD	VAL-CP-RCD-3S/40/0.3/SEL	2808001	1

#### Accessories

Replacement plug	L-N / L-PEN N-PE	VAL-CP-350-ST-GY	2882718	10
		VAL-CP-N/PE-350-ST-GY	2882734	10

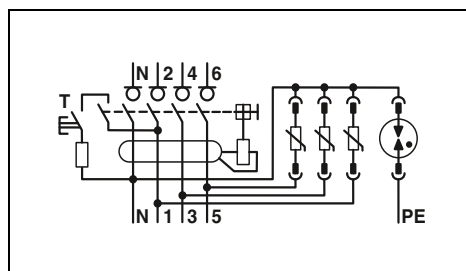

#### Technical data

Electrical data	
IEC test classification	II, T2
Nominal voltage $U_N$	240/415 V AC (TN-S) / 240/415 V AC (TT)
Maximum continuous operating voltage $U_C$	L-N / N-PE / L-PEN 350 V AC / 264 V AC / -
Nominal discharge current $I_n$ (8/20) $\mu$ s	L-N / N-PE / L-PEN 20 kA / 20 kA / -
Max. discharge current $I_{max}$ (8/20) $\mu$ s	L-N / N-PE / L-PEN 30 kA / 30 kA / -
Voltage protection level $U_p$	L-N / N-PE / L-PEN $\leq 2$ kV / $\leq 2$ kV / -
Short-circuit current rating $I_{SCCR}$	10 kA
Max. backup fuse with branch wiring	63 A AC (MCB)
Response time $t_A$	L-N / N-PE / L-PEN $\leq 25$ ns / $\leq 100$ ns / -

General data	
Dimensions W / H / D	121 mm / 90 mm / 76 mm
Connection data solid / stranded / AWG (IEC) / AWG (UL)	4 ... 25 mm <sup>2</sup> / 4 ... 25 mm <sup>2</sup> / - / -
Temperature range	-25°C ... 40°C
Inflammability class in acc. with UL 94	V-0
Test standards	IEC 61643-11 / EN 61643-11 / EN 61008-1 / IEC 60947-1 / IEC 60947-3

RCD data	
Tripping characteristic	A (si type)
Nominal load current $I_L$	40 A
Rated residual current	30 mA
Rated making and breaking capacity $I_m$	1.5 kA
Rated residual making and breaking capacity $I_{\Delta m}$	2.5 kA
Surge withstand capability	6 kV (1.2/50 $\mu$ s)
Immunity to short-circuiting $I_{nc}$	10 kA
Tripping time for $I_{\Delta n}$	$\leq 300$ ms
Tripping time for $5xI_{\Delta n}$	$\leq 40$ ms
Cycles, max.	20000
Utilization category	AC 23 A

#### Ordering data

Description	Type	Order No.	Pcs. / Pkt.
VALVETRAB compact with RCD	VAL-CP-RCD-3S/40/0.03	2882802	1

#### Accessories

Replacement plug	L-N / L-PEN N-PE	VAL-CP-350-ST-GY	2882718	10
		VAL-CP-N/PE-350-ST-GY	2882734	10

# Surge protection and interference suppression filters

## Surge protection for the power supply

### Type 2 surge arrester for 60 mm system technology Combi-MCB

- Combinations of type 2 arresters with integrated arrester backup fuse
- For 60 mm system technology
- Tool-free mounting on 5 and 10 mm busbars
- Signaling to monitoring systems via remote indication contact in the event of an error
- Surge-proof arrester backup fuse tailored to type 2 arresters
- Type 2 surge arresters with consistent plug-in design
- Disconnect device on each individual plug
- Optical, mechanical status indication for the individual arresters
- Plugs can be checked with CHECKMASTER

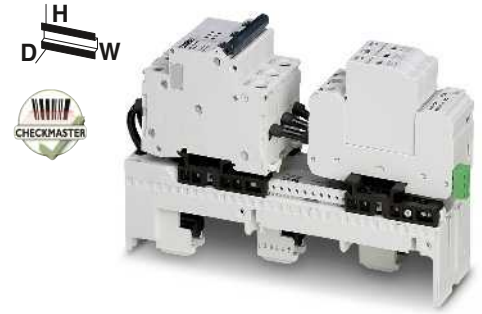
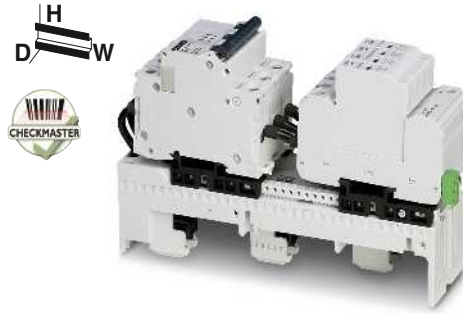

ERC

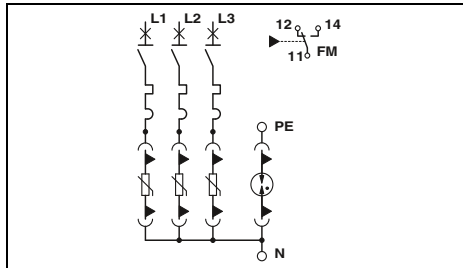

ERC

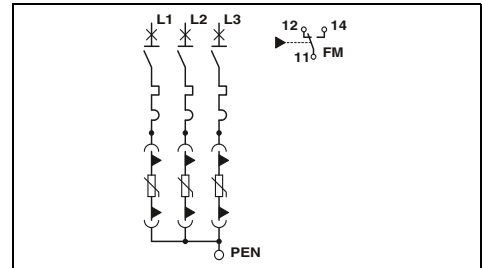

#### Technical data

Electrical data	
IEC test classification	II, T2
Nominal voltage $U_N$	240/415 V AC (TN-S) / 240/415 V AC (TT)
Maximum continuous operating voltage $U_C$	L-N / N-PE / L-PEN 350 V AC / 264 V AC / -
Nominal discharge current $I_n$ (8/20) $\mu$ s	L-N / N-PE / L-PEN 20 kA / 20 kA / -
Max. discharge current $I_{max}$ (8/20) $\mu$ s	L-N / N-PE / L-PEN 25 kA / 40 kA / -
Voltage protection level $U_p$	L-N / N-PE / L-PEN $\leq 2.5$ kV / $\leq 1.5$ kV / -
Short-circuit current rating $I_{SCCR}$	25 kA
Max. backup fuse with branch wiring	Not required
Response time $t_A$	L-N / N-PE / L-PEN $\leq 25$ ns / $\leq 100$ ns / -
General data	
Dimensions W / H / D	54 mm / 220 mm / 134 mm
Connection data solid / stranded / AWG (IEC) / AWG (UL)	2.5 ... 25 mm <sup>2</sup> / 2.5 ... 16 mm <sup>2</sup> / - / -
Temperature range	-25°C ... 55°C
Inflammability class in acc. with UL 94	V-0
Test standards	IEC 61643-11 / EN 61643-11
Remote indication contact	PDT contact
Connection data solid / stranded / AWG (IEC) / AWG (UL)	0.14 ... 1.5 mm <sup>2</sup> / 0.14 ... 1.5 mm <sup>2</sup> / 28 - 16 / -
Max. operating voltage	250 V AC / 125 V DC (200 mA DC)
Max. operating current	1 A AC / 1 A DC (30 V DC)

#### Technical data

Electrical data	
IEC test classification	II, T2
Nominal voltage $U_N$	240/415 V AC (TN-C) / 240/415 V AC (TT)
Maximum continuous operating voltage $U_C$	- / - / 350 V AC
Nominal discharge current $I_n$ (8/20) $\mu$ s	- / - / 20 kA
Max. discharge current $I_{max}$ (8/20) $\mu$ s	- / - / 25 kA
Voltage protection level $U_p$	- / - / $\leq 2.5$ kV
Short-circuit current rating $I_{SCCR}$	25 kA
Max. backup fuse with branch wiring	Not required
Response time $t_A$	- / - / $\leq 25$ ns
General data	
Dimensions W / H / D	54 mm / 220 mm / 134 mm
Connection data solid / stranded / AWG (IEC) / AWG (UL)	2.5 ... 25 mm <sup>2</sup> / 2.5 ... 16 mm <sup>2</sup> / - / -
Temperature range	-25°C ... 55°C
Inflammability class in acc. with UL 94	V-0
Test standards	IEC 61643-11 / EN 61643-11
Remote indication contact	PDT contact
Connection data solid / stranded / AWG (IEC) / AWG (UL)	0.14 ... 1.5 mm <sup>2</sup> / 0.14 ... 1.5 mm <sup>2</sup> / 28 - 16 / -
Max. operating voltage	250 V AC / 125 V DC (200 mA DC)
Max. operating current	1 A AC / 1 A DC (30 V DC)

#### Ordering data

Description	Type	Order No.	Pcs. / Pkt.
VALVETRAB compact	VAL-CP-MOSO 60-3S-FM	2804403	1

#### Ordering data

Description	Type	Order No.	Pcs. / Pkt.
VALVETRAB compact	VAL-CP-MOSO 60-3C-FM	2804416	1

#### Accessories

Replacement plug	L-N / L-PEN N-PE	VAL-CP-350-ST-GY	2882718	10
		VAL-CP-N/PE-350-ST-GY	2882734	10

#### Accessories

Replacement plug	L-N / L-PEN N-PE	VAL-CP-350-ST-GY	2882718	10
		VAL-CP-N/PE-350-ST-GY	2882734	10

### Type 2 surge arrester with integrated backup fuse Combi-MCB

- Combinations of type 2 arresters with integrated arrester backup fuse
- Overload of the surge protection results in all-pos. disconnection from the mains
- Signaling to monitoring systems via remote indication contact in the event of an error
- Surge-proof arrester backup fuse tailored to type 2 arresters
- Type 2 surge arresters with consistent plug-in design
- Disconnect device on each individual plug
- Optical, mechanical status indication for the individual arresters
- Plugs can be checked with CHECKMASTER



5-conductor system; L1, L2, L3, N, PE



4-conductor system; L1, L2, L3, PEN

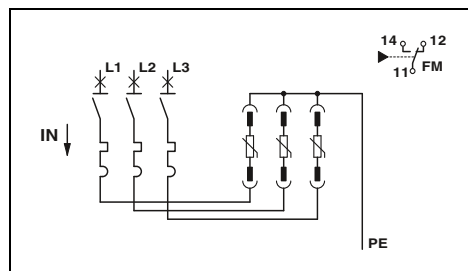
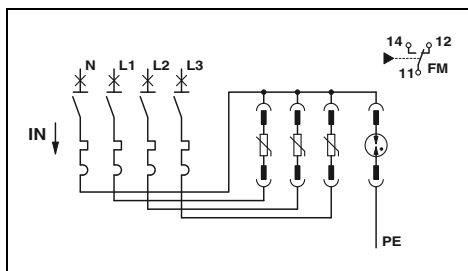

#### Technical data

Electrical data	... 3S-350	... 1S-350
IEC test classification	II, T2	II, T2
Nominal voltage $U_N$	240/415 V AC (TN-S) / 240/415 V AC (TT)	240 V AC (TN-S) / 240 V AC (TT)
Maximum continuous operating voltage $U_C$	L-N / N-PE / L-PEN 350 V AC / 264 V AC / -	350 V AC / 264 V AC / -
Nominal discharge current $I_n$ (8/20) $\mu$ s	L-N / N-PE / L-PEN 20 kA / 20 kA / -	20 kA / 20 kA / -
Max. discharge current $I_{max}$ (8/20) $\mu$ s	L-N / N-PE / L-PEN 30 kA / 30 kA / -	30 kA / 30 kA / -
Voltage protection level $U_p$	L-N / N-PE / L-PEN $\leq 2.5$ kV / $\leq 1.7$ kV / -	$\leq 2.5$ kV / $\leq 1.7$ kV / -
Short-circuit current rating $I_{SCCR}$	-	25 kA
Max. backup fuse with branch wiring	-	-
Response time $t_A$	L-N / N-PE / L-PEN $\leq 25$ ns / $\leq 100$ ns / -	$\leq 25$ ns / $\leq 100$ ns / -
General data		
Dimensions W / H / D	131.5 mm / 101 mm / 76 mm	
Connection data solid / stranded / AWG (IEC) / AWG (UL)	4 ... 35 mm <sup>2</sup> / 4 ... 25 mm <sup>2</sup> / - / -	
Temperature range	-25°C ... 60°C	
Inflammability class in acc. with UL 94	V-0	
Test standards	IEC 61643-11 / EN 61643-11 / IEC 60364-4-443 /	
Remote indication contact	PDT contact	
Connection data solid / stranded / AWG (IEC) / AWG (UL)	0.14 ... 1.5 mm <sup>2</sup> / 0.14 ... 1.5 mm <sup>2</sup> / 28 - 16 / -	
Max. operating voltage	250 V AC / 250 V DC	
Max. operating current	2 A AC / 1 mA DC ... 0.05 A DC	

#### Technical data

Electrical data	... 3C-350	
IEC test classification	II, T2	
Nominal voltage $U_N$	240/415 V AC (TN-C)	
Maximum continuous operating voltage $U_C$	- / - / 350 V AC	
Nominal discharge current $I_n$ (8/20) $\mu$ s	- / - / 20 kA	
Max. discharge current $I_{max}$ (8/20) $\mu$ s	- / - / 30 kA	
Voltage protection level $U_p$	- / - / $\leq 2.5$ kV	
Short-circuit current rating $I_{SCCR}$	25 kA	
Max. backup fuse with branch wiring	-	
Response time $t_A$	- / - / $\leq 25$ ns	
General data		
Dimensions W / H / D	114 mm / 101 mm / 76 mm	
Connection data solid / stranded / AWG (IEC) / AWG (UL)	4 ... 35 mm <sup>2</sup> / 4 ... 25 mm <sup>2</sup> / - / -	
Temperature range	-25°C ... 60°C	
Inflammability class in acc. with UL 94	V-0	
Test standards	IEC 61643-11 / EN 61643-11 / IEC 60364-4-443 /	
Remote indication contact	PDT contact	
Connection data solid / stranded / AWG (IEC) / AWG (UL)	0.14 ... 1.5 mm <sup>2</sup> / 0.14 ... 1.5 mm <sup>2</sup> / 28 - 16 / -	
Max. operating voltage	250 V AC / 250 V DC	
Max. operating current	2 A AC / 1 mA DC ... 0.05 A DC	

#### Ordering data

Description	Type	Order No.	Pcs. / Pkt.
VALVETRAB compact, with an arrester backup fuse	VAL-CP-MCB-3S-350/40/FM	2882750	1
VALVETRAB compact, with an arrester backup fuse	VAL-CP-MCB-1S-350/40/FM	2882763	1

#### Ordering data

Description	Type	Order No.	Pcs. / Pkt.
VALVETRAB compact, with an arrester backup fuse	VAL-CP-MCB-3C-350/40/FM	2882776	1

#### Accessories

Replacement plug	Type	Order No.	Pcs. / Pkt.
L-N / L-PEN	VAL-CP-350-ST-GY	2882718	10
N-PE	VAL-CP-N/PE-350-ST-GY	2882734	10

#### Accessories

Replacement plug	Type	Order No.	Pcs. / Pkt.
L-N / L-PEN	VAL-CP-350-ST-GY	2882718	10

## Surge protection for the power supply

### Type 3 device protection PLUGTRAB and BLOCKTRAB

#### MAINS-PLUGTRAB

- DIN rail module
- Consisting of base element and plug
- With floating remote indication contact
- Optical signaling of disconnection via LED
- Tool-free plug replacement
- Plugs can be checked with CHECKMASTER

**BT-1S-230AC/...** serves as device protection in deep installation boxes (in acc. with DIN 49073), cable ducts, underfloor systems, and end devices.

- With double spring-cage terminal blocks for tool-free conductor connection
- Side latches for easy fixing
- Optical/audible signaling of disconnection

#### Notes:

For approvals and dimensional drawing, visit [phoenixcontact.net/products](http://phoenixcontact.net/products)



3-conductor system, for single-phase DC power supply units

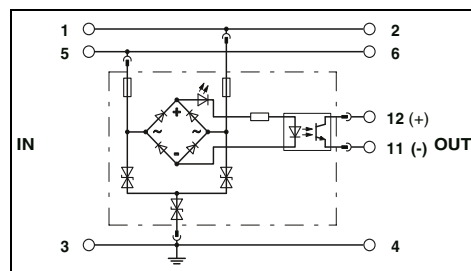

Electrical data	
IEC test classification	... 48AC
Nominal voltage $U_N$	III / T3
Maximum continuous operating voltage $U_C$	48 V DC
Rated load current $I_L$	L-N / L-PE
Combined surge $U_{OC}$	- / 60 V DC
Nominal discharge current $I_n$ (8/20) $\mu$ s	26 A (30°C)
Protection level $U_p$	6 kV (for 12 $\Omega$ )
Max. backup fuse in acc. with IEC	500 A
Response time $t_A$	L-N / L(N)-PE
	$\leq 120$ V / $\leq 120$ V
	25 A (gL)
	L-N / L(N)-PE
	$\leq 1$ ns / $\leq 1$ ns
General data	
Dimensions W / H / D	17.7 mm / 90 mm / 65.5 mm
Connection data solid / stranded / AWG	0.2 ... 4 mm <sup>2</sup> / 0.2 ... 2.5 mm <sup>2</sup> / -
Temperature range	-40°C ... 85°C
Inflammability class in acc. with UL 94	V0
Test standards	IEC 61643-1 / EN 61643-11/A11 / BS 6651 / ANS/IEEE C62.41 / EN 50082-2

#### Technical data

Description	Voltage $U_N$
<b>MAINS-PLUGTRAB</b> , consisting of a plug and base element	48 V DC 230 V AC
<b>BLOCKTRAB</b> , for universal mounting	230 V AC

#### Ordering data

Type	Order No.	Pcs. / Pkt.
<b>PT 2+1-S-48DC/FM</b>	<b>2817958</b>	10

Replacement plug	
	1L-N & N-PE 1L-N & N-PE
<b>Grounding connector</b> , for MAINS-PLUGTRAB base elements	

#### Accessories

<b>PT 2+1-S-48DC-ST</b>	<b>2839648</b>	10
<b>PT MAIN-EST</b>	<b>2880736</b>	10



3-conductor system, L, L, PE (IT system)



For universal mounting, optical signaling



For universal mounting, audible signaling

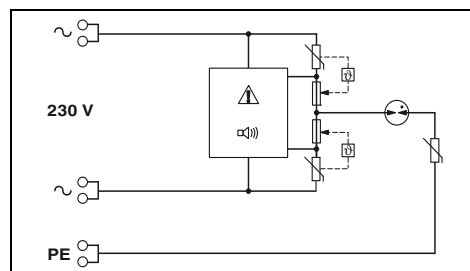
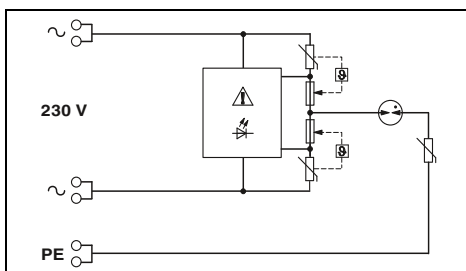
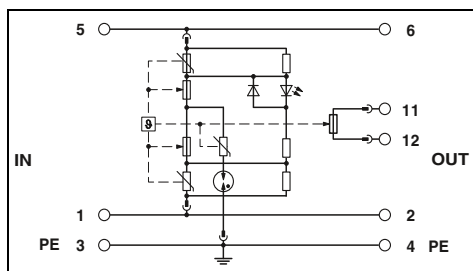

Technical data	
... 230AC	
III / T3	
230 V AC	
275 V AC / 440 V AC	
16 A (60°C)	
6 kV	
3 kA	
≤ 1.2 kV / ≤ 1.5 kV	
16 A AC (MCB-B)	
≤ 25 ns / ≤ 100 ns	
17.7 mm / 90 mm / 65.5 mm	
2.5 ... 4 mm <sup>2</sup> / 2.5 ... 4 mm <sup>2</sup> / 24 - 12	
-40°C ... 70°C	
V-0	
IEC 61643-11 / EN 61643-11	

Technical data	
... 230AC	
III / T3	
230 V AC -	
275 V AC / 440 V AC	
16 A (30°C)	
6 kV	
3 kA	
≤ 1.3 kV / ≤ 1.5 kV	
16 A AC (MCB-B)	
≤ 25 ns / ≤ 100 ns	
22.5 mm / 43 mm / 27.4 mm	
0.2 ... 2.5 mm <sup>2</sup> / 0.2 ... 2.5 mm <sup>2</sup> / 24 - 14	
-30°C ... 75°C	
V-0	
IEC 61643-11 / EN 61643-11	

Technical data	
... 230AC	
III / T3	
230 V AC -	
275 V AC / 440 V AC	
16 A (30°C)	
6 kV	
3 kA	
≤ 1.3 kV / ≤ 1.5 kV	
16 A AC (MCB-B)	
≤ 25 ns / ≤ 100 ns	
22.5 mm / 43 mm / 26.2 mm	
0.2 ... 2.5 mm <sup>2</sup> / 0.2 ... 2.5 mm <sup>2</sup> / 24 - 14	
-30°C ... 75°C	
V-0	
IEC 61643-11 / EN 61643-11	

Ordering data		
Type	Order No.	Pcs. / Pkt.
PLT-T3-IT-230-FM	2906450	1

Ordering data		
Type	Order No.	Pcs. / Pkt.
BT-1S-230AC/O	2800625	1

Ordering data		
Type	Order No.	Pcs. / Pkt.
BT-1S-230AC/A	2803409	10

Accessories		
Type	Order No.	Pcs. / Pkt.
PLT-T3-IT-230-P	2906451	1
PT MAIN-EST	2880736	10

Accessories		
Type	Order No.	Pcs. / Pkt.

Accessories		
Type	Order No.	Pcs. / Pkt.

# Surge protection and interference suppression filters

## Surge protection for the power supply

### Type 3 device protection MAINTRAB

- Attachment plug
- For individual end devices
- With increased touch-proof protection
- Optical signaling of the surge voltage function via LED
- For protecting the power supply and signal lines
- Including required accessories



Attachment plug



For network and ISDN/DSS1 systems/end devices, with RJ45 connection

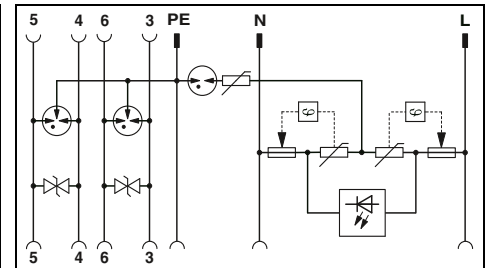
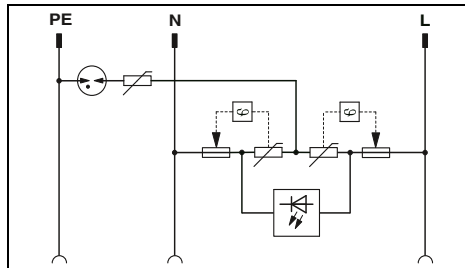

#### Technical data

Electrical data		
IEC test classification/EN type		III / T3
Nominal voltage $U_N$		230 V AC
Maximum continuous operating voltage $U_C$	L-N / L-PE	275 V AC / 360 V AC
	Core-Core / Core-Ground / Core-Shield	- / - / -
Nominal load current $I_L$		-
Nominal discharge current $I_n$ (8/20) $\mu$ s	L-N / L-PE	3 kA / 3 kA
	Core-Core / Core-Ground / Core-Shield	- / - / -
Combined surge $U_{OC}$		4 kV
Protection level $U_p$	L-N / N-PE / L-PE	$\leq 1.2$ kV / $\leq 1.5$ kV / $\leq 1.5$ kV
	Core-Core / Core-Ground / Core-Shield	- / - / -
Response time $t_A$	L-N / L-PE	$\leq 25$ ns / $\leq 100$ ns
	Core-Ground / Core-Shield / Shield-Ground	- / - / -
Cut-off frequency $f_g$ (3 dB)		
In a 100 $\Omega$ system	Core-Core	-
In a 75 $\Omega$ system	Core-Shield	-
General data		
Dimensions W / H / D		56 mm / 76 mm / 78 mm
Temperature range		-25°C ... 75°C
Inflammability class in acc. with UL 94		V-0
Test standards		IEC 61643-11 / EN 61643-11

#### Technical data

Mains protection		Data protection
III / T3		C2
230 V AC		
275 V AC / 360 V AC		6 V DC / - / -
-		1.5 A (25°C)
3 kA / 3 kA		-
-		650 A / 2.5 kA / -
4 kV		-
$\leq 1.2$ kV / $\leq 1.5$ kV / $\leq 1.5$ kV		-
-		$\leq 65$ V (C1 - 1 kV/500 A) / $\leq 900$ V (C2 - 4 kV/2 kA) / -
$\leq 25$ ns / $\leq 100$ ns		-
-		$\leq 1$ ns / $\leq 100$ ns / -
-		typ. 300 kHz
-		-
		76 mm / 103 mm / 78 mm
		-25°C ... 75°C
		V-0
		IEC 61643-11 / EN 61643-11 / EN 61643-21/A2 /

#### Ordering data

Description	can be used in the following:	Type	Order No.	Pcs. / Pkt.
<b>MAINTRAB</b> , attachment plug with signal lamp for plugging into a socket, for device protection	D, A, NL, E, S, FIN, TR	MNT-1 D	2882200	1
	D, A, NL, E, S, FIN, TR	MNT-1 D/WH	2882213	1
black	D			
white	D			
black	NL, E, I, S, FIN, TR			
white	NL, E, I, S, FIN, TR			
black	B, F, CZ, SVK, PL	MNT-NET B/F	2882226	1
black	CH	MNT-1 CH II	2882255	1

#### Ordering data

Type	Order No.	Pcs. / Pkt.
MNT-ISDN D	2882336	1
MNT-ISDN D/WH	2882349	1



**DSL**



For telecommunications systems with TAE connection

**DSL**



For telecommunications systems with RJ12 connection



For network and TV antennas/cables and SAT systems, with F connector and IEC adapter

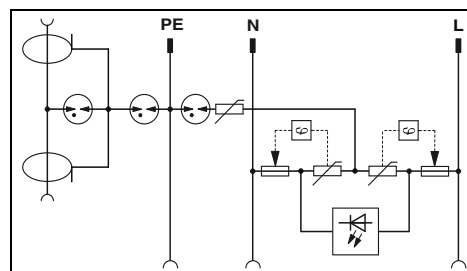
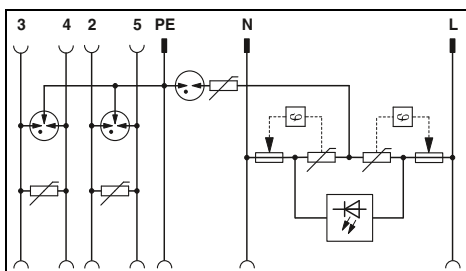
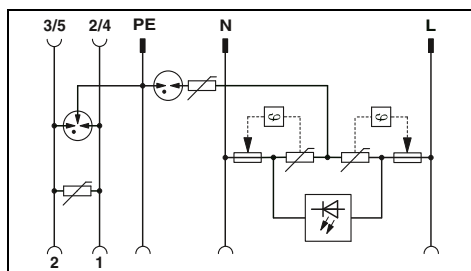

Technical data	
Mains protection III / T3 230 V AC	Data protection C1
275 V AC / 360 V AC	200 V DC / - / - 1.5 A (25°C)
3 kA / 3 kA	-
4 kV	1 kA / 2.5 kA / -
≤ 1.2 kV / ≤ 1.5 kV / ≤ 1.5 kV	-
-	≤ 460 V (C2 - 1 kA) / ≤ 900 V (C2 - 2 kA) / -
≤ 25 ns / ≤ 100 ns	-
-	≤ 25 ns / ≤ 100 ns / -
-	typ. 4 MHz
63 mm / 103 mm / 78 mm -25°C ... 75°C V-0 IEC 61643-11 / EN 61643-11 / EN 61643-21/A2 /	

Technical data	
Mains protection III / T3 230 V AC	Data protection C1
275 V AC / 360 V AC	200 V DC / - / - 1.5 A (25°C)
3 kA / 3 kA	-
4 kV	3 kA / 3 kA / -
≤ 1.2 kV / ≤ 1.5 kV / ≤ 1.5 kV	-
-	≤ 460 V (C2 - 1 kA) / ≤ 900 V (C2 - 2 kA) / -
≤ 25 ns / ≤ 100 ns	-
-	≤ 25 ns / ≤ 100 ns / -
-	typ. 4 MHz
63 mm / 103 mm / 78 mm -25°C ... 75°C V-0 IEC 61643-11 / EN 61643-11 / EN 61643-21/A2 /	

Technical data	
Mains protection III / T3 230 V AC	Data protection C2
275 V AC / 360 V AC	- / - / - 1.5 A (25°C)
3 kA / 3 kA	-
4 kV	- / 2.5 kA / 2.5 kA
≤ 1.2 kV / ≤ 1.5 kV / ≤ 1.5 kV	-
-	- / - / ≤ 700 V (C2 - 2 kA)
≤ 25 ns / ≤ 100 ns	-
-	- / - / ≤ 100 ns
-	-
-	> 2.5 GHz
63 mm / 107 mm / 78 mm -25°C ... 75°C V-0 IEC 61643-11 / EN 61643-11 / EN 61643-21/A2 /	

Ordering data		
Type	Order No.	Pcs. / Pkt.
MNT-TAE D	2882381	1
MNT-TAE D/WH	2882394	1

Ordering data		
Type	Order No.	Pcs. / Pkt.
MNT-TELE E	2882417	1
MNT-TELE S/WH	2880901	1
MNT-TEL B/F	2882404	1

Ordering data		
Type	Order No.	Pcs. / Pkt.
MNT-TV-SAT D	2882284	1
MNT-TV-SAT D/WH	2882297	1
MNT-TV-SAT B/F	2882307	1

# Surge protection and interference suppression filters

## Surge protection for the power supply

### Lightning and surge arresters for PV systems

- Type 1 and type 2 arresters with consistent plug-in design
- Reliable contact, thanks to integrated rotating latch
- Optical, mechanical status indication for the individual arresters
- With or without floating remote indication contact
- Mechanical coding of all slots



**Type 1/2 arrester for insulated and single-sided grounded PV applications**



**Type 2 arrester for insulated and single-sided grounded PV applications**

UL ENEC KEBA  
Total width 53.4 mm

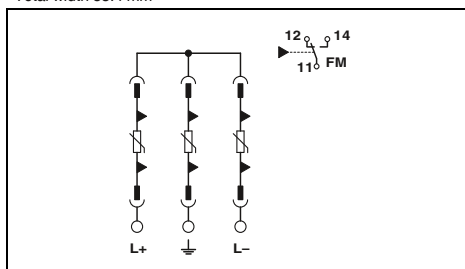

#### Technical data

Electrical data	... 1000 DC	... 600 DC
IEC test classification	PV T1, -	PV T1, -
Impulse discharge current $I_{imp}$ (10/350) $\mu$ s		
	Peak value $I_{imp}$	
Nominal discharge current $I_n$ (8/20) $\mu$ s	5 kA	5 kA
Max. discharge current $I_{max}$ (8/20) $\mu$ s	15 kA	15 kA
Protection level $U_p$	40 kA	40 kA
	(L+) - (L-) / (L+/-) - PE	
Open circuit voltage $U_{OCSTC}$	$\leq 3.5$ kV / -	$\leq 2.6$ kV / -
Maximum continuous operating voltage $U_{CPV}$	$\leq 875$ V DC	$\leq 600$ V DC
Short-circuit current rating $I_{SCPV}$	1050 V DC	720 V DC
Non-load voltage $U_{OC}$ (max. permissible)	1000 A	1000 A
Short-circuit current $I_{SCSTC}$ (max. permissible)	-	-
General data		
Dimensions W / H / D	53.4 mm / 99 mm / 65.5 mm	
Connection data solid / stranded / AWG	1.5 ... 35 mm <sup>2</sup> / 1.5 ... 25 mm <sup>2</sup> / 10 - 2	
Temperature range	-40°C ... 80°C	
Degree of protection in acc. with IEC 60529/EN 60529	-	
Housing material	PA 6.6-FR	
Inflammability class in acc. with UL 94	V-0	
Test standards	EN 50539-11	
Remote indication contact	PDT contact	
Connection data solid / stranded / AWG	0.14 ... 1.5 mm <sup>2</sup> / 0.14 ... 1.5 mm <sup>2</sup> / 30 - 14	
Max. operating voltage	250 V AC / 30 V DC	
Max. operating current	1.5 A AC (250 V AC) / 1.5 A DC (30 V DC)	

UL ENEC KEBA  
Total width 53.4 mm

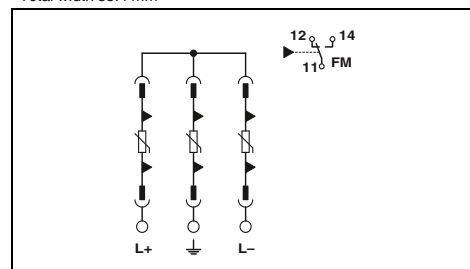

#### Technical data

Electrical data	... 1000 DC	... 600 DC
IEC test classification	PV T2, -	PV T2, -
Impulse discharge current $I_{imp}$ (10/350) $\mu$ s		
	Peak value $I_{imp}$	
Nominal discharge current $I_n$ (8/20) $\mu$ s	-	-
Max. discharge current $I_{max}$ (8/20) $\mu$ s	15 kA	15 kA
Protection level $U_p$	40 kA	40 kA
	(L+) - (L-) / (L+/-) - PE	
Open circuit voltage $U_{OCSTC}$	$\leq 3.7$ kV / -	$\leq 2.7$ kV / -
Maximum continuous operating voltage $U_{CPV}$	$\leq 970$ V DC	$\leq 670$ V DC
Short-circuit current rating $I_{SCPV}$	1170 V DC	800 V DC
Non-load voltage $U_{OC}$ (max. permissible)	1000 A	1000 A
Short-circuit current $I_{SCSTC}$ (max. permissible)	-	-
General data		
Dimensions W / H / D	53.4 mm / 99 mm / 65.5 mm	
Connection data solid / stranded / AWG	1.5 ... 35 mm <sup>2</sup> / 1.5 ... 25 mm <sup>2</sup> / 10 - 2	
Temperature range	-40°C ... 80°C	
Degree of protection in acc. with IEC 60529/EN 60529	-	
Housing material	PA 6.6-FR	
Inflammability class in acc. with UL 94	V-0	
Test standards	EN 50539-11	
Remote indication contact	PDT contact	
Connection data solid / stranded / AWG	0.14 ... 1.5 mm <sup>2</sup> / 0.14 ... 1.5 mm <sup>2</sup> / 30 - 14	
Max. operating voltage	250 V AC / 30 V DC	
Max. operating current	1.5 A AC (250 V AC) / 1.5 A DC (30 V DC)	

#### Ordering data

Description	Type	Order No.	Pcs. / Pkt.
<b>VALVETRAB-MS</b>			
with remote indication contact	(L+)-PE & (L-)-PE & (L+)-(L-)	VAL-MS-T1/T2 1000DC-PV/2+V-FM	2801161
without remote indication contact	(L+)-PE & (L-)-PE & (L+)-(L-)	VAL-MS-T1/T2 1000DC-PV/2+V	2801160
with remote indication contact	(L+)-PE & (L-)-PE & (L+)-(L-)	VAL-MS-T1/T2 600DC-PV/2+V-FM	2801164
without remote indication contact	(L+)-PE & (L-)-PE & (L+)-(L-)	VAL-MS-T1/T2 600DC-PV/2+V	2801163
<b>Base element for surge arrester, without remote indication contact</b>			
<b>Lightning and surge arrester in IP65 housing, for protecting the DC side of an inverter</b>			
	(L+)-PE & (L-)-PE & (L+)-(L-)		

#### Ordering data

Description	Type	Order No.	Pcs. / Pkt.
<b>VALVETRAB-MS</b>			
with remote indication contact	(L+)-PE & (L-)-PE & (L+)-(L-)	VAL-MS 1000DC-PV/2+V-FM	2800627
without remote indication contact	(L+)-PE & (L-)-PE & (L+)-(L-)	VAL-MS 1000DC-PV/2+V	2800628
with remote indication contact	(L+)-PE & (L-)-PE & (L+)-(L-)	VAL-MS 600DC-PV/2+V-FM	2800641
without remote indication contact	(L+)-PE & (L-)-PE & (L+)-(L-)	VAL-MS 600DC-PV/2+V	2800642
<b>Base element for surge arrester, without remote indication contact</b>			
<b>Lightning and surge arrester in IP65 housing, for protecting the DC side of an inverter</b>			
	(L+)-PE & (L-)-PE & (L+)-(L-)		

#### Accessories

Description	Type	Order No.	Pcs. / Pkt.
<b>Replacement plug</b>			
1000 V DC	VAL-MS-T1/T2 1000DC-PV-ST	2801162	1
600 V DC	VAL-MS-T1/T2 600DC-PV-ST	2801165	1

#### Accessories

Description	Type	Order No.	Pcs. / Pkt.
<b>Replacement plug</b>			
1000 V DC	VAL-MS 1000DC-PV-ST	2800624	1
600 V DC	VAL-MS 600DC-PV-ST	2800623	1



4-pos. base element for insulated and single-sided grounded DC voltage systems up to 1000 V DC



Collects four solar strings on one MPP tracker, with SUNCLIX



Collects three solar strings on one MPP tracker, with SUNCLIX, with fire service switch

Total width 71.2 mm

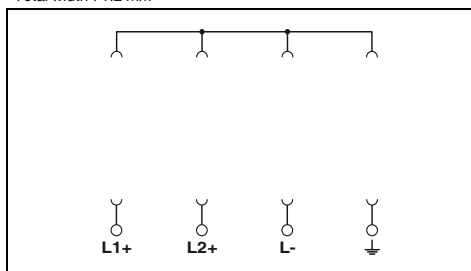

### Technical data

PV T2, T2  
-  
-  
-  
-/-  
1170 V DC  
1000 A  
-  
-  
71.2 mm / 90 mm / 51.5 mm  
1.5 ... 35 mm<sup>2</sup> / 1.5 ... 25 mm<sup>2</sup> / 10 - 2  
-40°C ... 80°C  
-  
PBT  
V-0  
EN 50539-11  
-  
-/-/-  
-

### Ordering data

Type	Order No.	Pcs. / Pkt.
VAL-MS 3+V-BE	2905859	32

### Accessories

VAL-MS 1000DC-PV-ST	2800624	1
---------------------	---------	---

ERC

Total width 254 mm

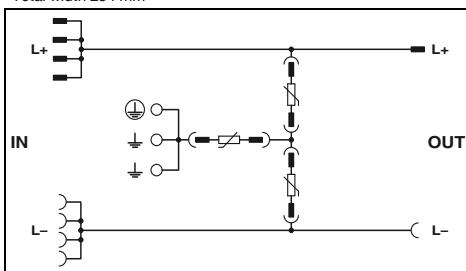

### Technical data

PV T1, -  
5 kA  
15 kA  
40 kA  
≤ 3.5 kV / ≤ 3.5 kV  
830 V DC (solar generator)  
-  
-  
≤ 1000 V DC (solar generator)  
≤ 10 A DC (per string)  
254 mm / 180 mm / 123 mm  
-/-/-  
-25°C ... 40°C  
IP65  
Polystyrene  
HB  
IEC 61439-2 / EN 61439-2 / EN 50539-11  
PDT, 1-pos.  
0.14 ... 1.5 mm<sup>2</sup> / 0.14 ... 1.5 mm<sup>2</sup> / 30 - 14  
250 V AC / 30 V DC  
1.5 A AC (250 V AC) / 1.5 A DC (30 V DC)

### Ordering data

Type	Order No.	Pcs. / Pkt.
PV-SET 4ST/1000DC/SPD-SC	2801297	1

### Accessories

VAL-MS-T1/T2 1000DCPV-UD-ST	2801231	10
-----------------------------	---------	----

ERC

Total width 250 mm

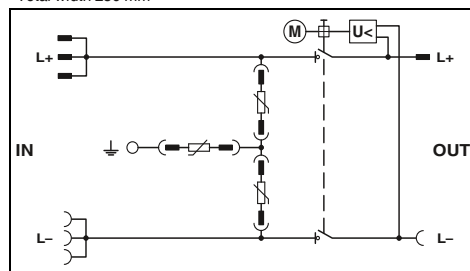

### Technical data

PV T1, -  
5 kA  
15 kA  
40 kA  
≤ 3.5 kV / ≤ 3.5 kV  
830 V DC (solar generator)  
-  
-  
≤ 1000 V DC (solar generator)  
≤ 30 A DC (total)  
250 mm / 370 mm / 122 mm  
-/-/-  
-20°C ... 45°C  
IP65  
Polycarbonate, fiberglass reinforced  
V2 (housing)  
IEC 61439-2 / EN 61439-2 / EN 50539-11  
PDT, 1-pos.  
0.14 ... 1.5 mm<sup>2</sup> / 0.14 ... 1.5 mm<sup>2</sup> / 30 - 14  
250 V AC / 30 V DC  
1.5 A AC (250 V AC) / 1.5 A DC (30 V DC)

### Ordering data

Type	Order No.	Pcs. / Pkt.
PV-SET 3ST-SPD-FESD-SC	2901860	1

### Accessories

VAL-MS-T1/T2 1000DC-PV-ST	2801162	1
---------------------------	---------	---

# Surge protection and interference suppression filters

## Surge protection for the power supply

### Surge protection for photovoltaic systems

- For insulated or grounded PV applications up to 1000 V DC
- Pre-assembled protection solutions
- Suitable for DC applications such as PV systems
- Type 1/2 lightning and surge arresters with consistent plug-in design
- Optical, mechanical status indication for the individual arresters
- Mechanical coding of all slots
- Plugs can be checked with CHECKMASTER



For one solar string



Collects two solar strings on two MPP trackers, with SUNCLIX

ERC  
Total width 125 mm

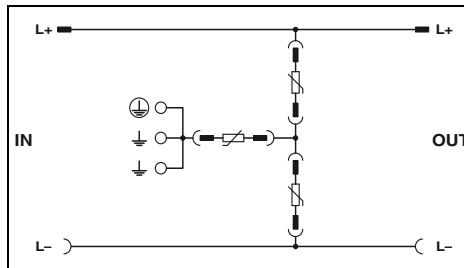

#### Technical data

Electrical data	
IEC test classification	PV T1, -
Impulse discharge current $I_{imp}$ (10/350) $\mu$ s	Peak value $I_{imp}$
	5 kA
Nominal discharge current $I_n$ (8/20) $\mu$ s	15 kA
Max. discharge current $I_{max}$ (8/20) $\mu$ s	40 kA
Protection level $U_p$	$\leq 3.5$ kV / $\leq 3.5$ kV
	(L+) - (L-) / (L+/-) - PE
Non-load voltage $U_{OC}$ (max. permissible)	$\leq 1000$ V DC (solar generator)
Short-circuit current $I_{SCSTC}$ (max. permissible)	$\leq 32$ A DC
General data	
Dimensions W / H / D	125 mm / 200 mm / 122 mm
Temperature range	-30°C ... 55°C
Degree of protection in acc. with IEC 60529/EN 60529	IP65
Housing material	Polycarbonate, fiberglass reinforced
Inflammability class in acc. with UL 94	V2 (housing/cover)
Test standards	IEC 61439-2 / EN 61439-2 / EN 50539-11
Remote indication contact	PDT, 1-pos.
Connection data solid / stranded / AWG	0.14 ... 1.5 mm <sup>2</sup> / 0.14 ... 1.5 mm <sup>2</sup> / 30 - 14
Max. operating voltage	250 V AC / 30 V DC
Max. operating current	1.5 A AC (250 V AC) / 1.5 A DC (30 V DC)

ERC  
Total width 200 mm

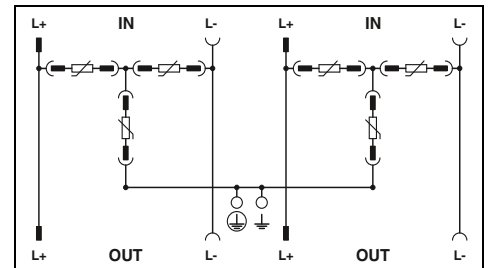

#### Technical data

Electrical data	
IEC test classification	PV T1, -
Impulse discharge current $I_{imp}$ (10/350) $\mu$ s	Peak value $I_{imp}$
	5 kA
Nominal discharge current $I_n$ (8/20) $\mu$ s	15 kA
Max. discharge current $I_{max}$ (8/20) $\mu$ s	40 kA
Protection level $U_p$	$\leq 3.5$ kV / $\leq 3.5$ kV
	$\leq 1000$ V DC (solar generator)
Non-load voltage $U_{OC}$ (max. permissible)	$\leq 32$ A DC (per MPP)
Short-circuit current $I_{SCSTC}$ (max. permissible)	
General data	
Dimensions W / H / D	200 mm / 200 mm / 122 mm
Temperature range	-30°C ... 55°C
Degree of protection in acc. with IEC 60529/EN 60529	IP65
Housing material	Polycarbonate, fiberglass reinforced
Inflammability class in acc. with UL 94	V2 (housing/cover)
Test standards	IEC 61439-2 / EN 61439-2 / EN 50539-11
Remote indication contact	PDT, 1-pos.
Connection data solid / stranded / AWG	0.14 ... 1.5 mm <sup>2</sup> / 0.14 ... 1.5 mm <sup>2</sup> / 30 - 14
Max. operating voltage	250 V AC / 30 V DC
Max. operating current	1.5 A AC (250 V AC) / 1.5 A DC (30 V DC)

#### Ordering data

Description	Type	Order No.	Pcs. / Pkt.
Surge protection in IP65 housing, for photovoltaic systems up to 1000 V DC (L+)-PE & (L-)-PE & (L+)-(L-)	PV-SET 1ST/1000DC/1MPP-SPD-SC	2801529	1

#### Accessories

Replacement plug	VAL-MS-T1/T2 1000DC-PV-ST	Order No.	Pcs. / Pkt.
L-N / L-PEN N-PE	2801162	1	

#### Ordering data

Description	Type	Order No.	Pcs. / Pkt.
Surge protection in IP65 housing, for photovoltaic systems up to 1000 V DC (L+)-PE & (L-)-PE & (L+)-(L-)	PV-SET 2ST/1000DC/2MPP-SPD-SC	2801317	1

#### Accessories

Replacement plug	VAL-MS-T1/T2 1000DC-PV-ST	Order No.	Pcs. / Pkt.
L-N / L-PEN N-PE	2801162	1	



Collects three solar strings on three MPP trackers, with SUNCLIX



Collects two solar strings on one MPP tracker, with generator disconnect



Collects four solar strings on two MPP trackers, protection for 3-phase AC supply

Total width 300 mm

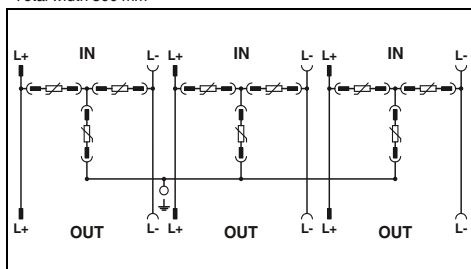

### Technical data

PV T1, -  
5 kA  
15 kA  
40 kA  
  
≤ 3.5 kV / ≤ 3.5 kV  
≤ 1000 V DC (solar generator)  
≤ 32 A DC (per MPP)

300 mm / 300 mm / 142 mm  
-30°C ... 55°C  
IP65  
Polycarbonate, fiberglass reinforced  
V2 (housing/cover)  
IEC 61439-2 / EN 61439-2 / EN 50539-11  
PDT, 1-pos.  
0.14 ... 1.5 mm<sup>2</sup> / 0.14 ... 1.5 mm<sup>2</sup> / 30 - 14  
250 V AC / 30 V DC  
1.5 A AC (250 V AC) /  
1.5 A DC (30 V DC)

### Ordering data

Type	Order No.	Pcs. / Pkt.
PV-SET 3ST/1000DC/3MPP-SPD-SC	2801531	1

### Accessories

VAL-MS-T1/T2 1000DC-PV-ST	2801162	1
---------------------------	---------	---

ERC  
Total width 200 mm

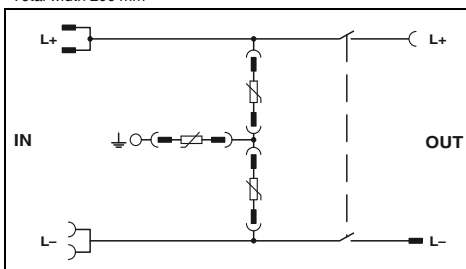

### Technical data

PV T1, -  
5 kA  
15 kA  
40 kA  
  
≤ 3.5 kV / ≤ 3.5 kV  
1000 V DC (solar generator)  
≤ 32 A DC

200 mm / 200 mm / 122 mm  
-20°C ... 40°C  
IP65  
Polycarbonate, fiberglass reinforced  
V2 (housing/cover)  
IEC 61439-2 / EN 61439-2 / EN 50539-11  
PDT, 1-pos.  
0.14 ... 1.5 mm<sup>2</sup> / 0.14 ... 1.5 mm<sup>2</sup> / 30 - 14  
250 V AC / 30 V DC  
1.5 A AC (250 V AC) /  
1.5 A DC (30 V DC)

### Ordering data

Type	Order No.	Pcs. / Pkt.
PV-SET 2ST/1000DC-SPD-SD-SC	2801318	1

### Accessories

VAL-MS-T1/T2 1000DC-PV-ST	2801162	1
---------------------------	---------	---

ERC  
Total width 377 mm

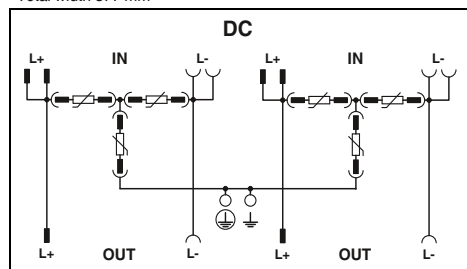

### Technical data

PV T1, -  
-  
15 kA (DC)  
40 kA (DC)  
  
≤ 3.5 kV / ≤ 3.5 kV  
≤ 1000 V DC (solar generator)  
4x 10.6 A (DC side)

377 mm / 200 mm / 122 mm  
-20°C ... 60°C  
IP65  
Polycarbonate, fiberglass reinforced  
V2 (housing/cover)  
IEC 61439-2 / EN 61439-2 / EN 50539-11 /  
PDT, 1-pos.  
0.14 ... 1.5 mm<sup>2</sup> / 0.14 ... 1.5 mm<sup>2</sup> / 28 - 16  
250 V AC / 125 V DC  
1 A AC (inductive) 1 A AC (ohmic) /  
200 mA DC (ohmic)

### Ordering data

Type	Order No.	Pcs. / Pkt.
PV-SET 1000DC-SC/AC-3P-QPD	2801604	1

### Accessories

VAL-MS-T1/T2 1000DCPV-UD-ST	2801231	10
VAL-CP-350-ST	2859602	10
VAL-CP-N/PE-350-ST	2859699	10

# Surge protection and interference suppression filters

## Surge protection for the power supply

### Type 1 protection for the power supply with integrated arrester backup fuse

#### FLT-SEC-HYBRID

Branch wiring in the TN-C network

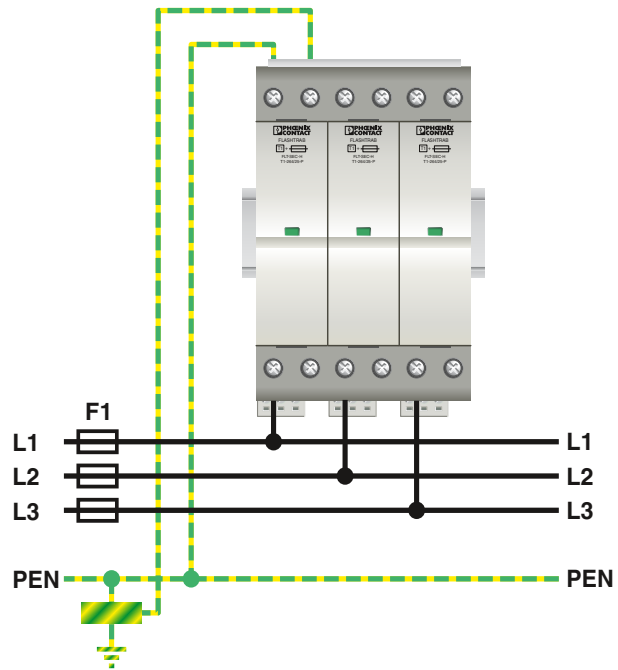

#### Technical characteristics

Typical installation location Upstream or downstream of the circuit breaker of low-voltage distribution boards with large load currents

Lightning Protection Level I, II, III, IV

Lightning protection zone transition LPZ 0<sub>A</sub> → LPZ 1

Coordination Coordination with type 2 arresters of the SEC family is guaranteed

Connecting cables

- Connection of  $S_{PEN}$  and  $S_{\downarrow}$  is mandatory (see figure).
- Use the following conductor cross sections for the connection (see table).
- Ensure that the  $S_L$  is installed in a way that is short-circuit-proof and protected against ground faults. Recommendation: use cables with increased temperature stability, such as VPE/EPR-insulated cables.

Backup fuses

- Can be used without backup fuse in branch wiring
- The integrated overcurrent protection is selective to upstream fuses  
 $F1 \geq 400 \text{ A gG}$

Products in the catalog Page 20

#### Connecting cables

$S_L / \text{mm}^2$	$S_{\downarrow} / \text{mm}^2$	$S_{PEN} / \text{mm}^2$
2 x 16	16	16

#### Remote signaling data

	$U_{\text{max}}$	$I_{\text{max}}$
AC	250 V	1 A
AC	125 V (UL)	1 A (UL)
DC	125 V	0.2 A
DC	30 V	1 A
0.14 mm <sup>2</sup> ... 1.5 mm <sup>2</sup>		

### Type 1 protection for the power supply

#### FLT-SEC-PLUS

Branch wiring in the TN-C network

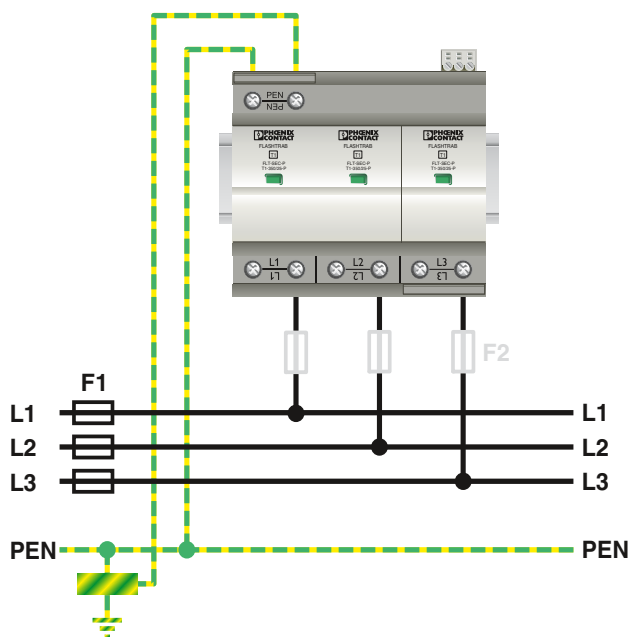

#### Technical characteristics

**Typical installation location** Where the cable enters the building or in the pre-meter or post-meter area

**Lightning Protection Level** I, II, III, IV

**Lightning protection zone transition** LPZ 0<sub>A</sub> → LPZ 1

**Coordination** Coordination with type 2 arresters of the SEC family is guaranteed

**Connecting cables** – Connection of  $S_{PEN}$  and  $S_{\downarrow}$  is mandatory (see figure).

- The required conductor cross sections are shown in the tables.
- Lay the connecting cables as short as possible, without loops, and with the largest possible bending radii

**Backup fuses** – Can be used without backup fuse in branch wiring up to 315 A gG

- If the surge protection fuse needs to be selective to the upstream installation, a separate F2 backup fuse is required. Once the F2 has tripped, there is no more surge protection for the system.

- Can be used without backup fuse in through wiring up to 125 A gG

Products in the catalog Page 21

#### Branch wiring

F1 A gG	F2 A gG	$S_L = S_N$ mm <sup>2</sup>	$S_{\downarrow}$ mm <sup>2</sup>	$S_{PE(N)}$ mm <sup>2</sup>
40		6	16	6
50		6	16	6
63		10	16	10
80		10	16	10
100		16	16	16
125		16	16	16
160		25	16	16
200		25	16	16
250		35	16	16
315		2 x 25	25	25
> 315	≤315	2 x 25	25	25

#### Through wiring

F1 A gG	$S_L = S_N$ mm <sup>2</sup>	$S_{\downarrow}$ mm <sup>2</sup>	$S_{PE(N)}$ mm <sup>2</sup>
40	6	16	6
50	10	16	10
63	10	16	10
80	16	16	16
100	25	16	16
125	35	16	16

#### Remote signaling data

	$U_{max}$	$I_{max}$
AC	250 V	1 A
AC	125 V (UL)	1 A (UL)
DC	125 V	0.2 A
DC	30 V	1 A
0.14 mm <sup>2</sup> ... 1.5 mm <sup>2</sup>		

# Surge protection and interference suppression filters

## Surge protection for the power supply

### Type 1+2 protection for the power supply

#### FLT-SEC-T1+T2

#### Branch wiring in the TN-S network

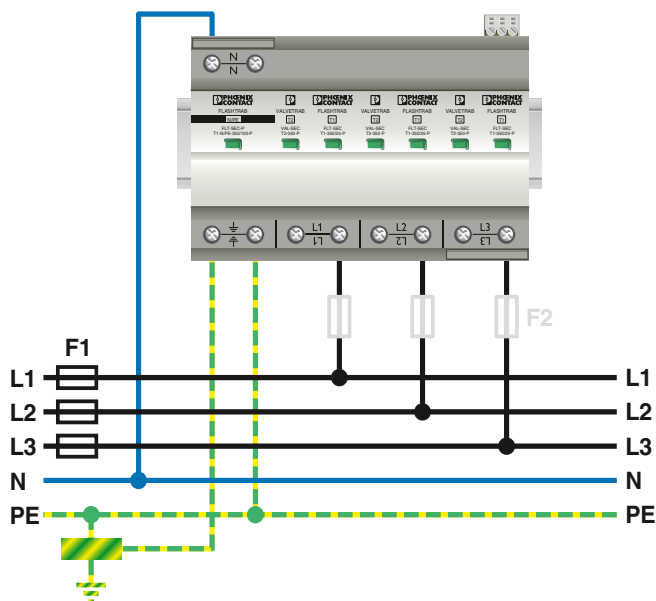

#### Technical characteristics

Typical installation location Where the cable enters the building in the post-meter area

Lightning Protection Level I, II, III, IV

Lightning protection zone LPZ 0<sub>A</sub> → LPZ 2 transition

Coordination Coordination with type 3 arresters of the SEC family is guaranteed

Connecting cables

- Connection of  $S_{PEN}$  and  $S_{\downarrow}$  is mandatory (see figure).
- The required conductor cross sections must be taken from the tables
- Lay the connecting cables as short as possible, without loops, and with the largest possible bending radii

Backup fuses

- Can be used without backup fuse in branch wiring up to 315 A gG
- If the surge protection fuse needs to be selective to the upstream installation, a separate F2 backup fuse is required. Once the F2 has tripped, there is no more surge protection for the system.
- Can be used without backup fuse in through wiring up to 125 A gG

Products in the catalog Page 25

#### Branch wiring

F1 A gG	F2 A gG	$S_L = S_N$ mm <sup>2</sup>	$S_{\downarrow}$ mm <sup>2</sup>	$S_{PE(N)}$ mm <sup>2</sup>
40		6	16	6
50		6	16	6
63		10	16	10
80		10	16	10
100		16	16	16
125		16	16	16
160		25	16	16
200		25	16	16
250		35	16	16
315		2 x 25	25	25
> 315	≤ 315	2 x 25	25	25

#### Through wiring

F1 A gG	$S_L = S_N$ mm <sup>2</sup>	$S_{\downarrow}$ mm <sup>2</sup>	$S_{PE(N)}$ mm <sup>2</sup>
40	6	16	6
50	10	16	10
63	10	16	10
80	16	16	16
100	25	16	16
125	35	16	16

#### Remote signaling data

	$U_{max}$	$I_{max}$
AC	250 V	1 A
AC	125 V (UL)	1 A (UL)
DC	125 V	0.2 A
DC	30 V	1 A
0.14 mm <sup>2</sup> to 1.5 mm <sup>2</sup>		



Type 2 protection for the power supply

VAL-SEC

Branch wiring in the TN-S network

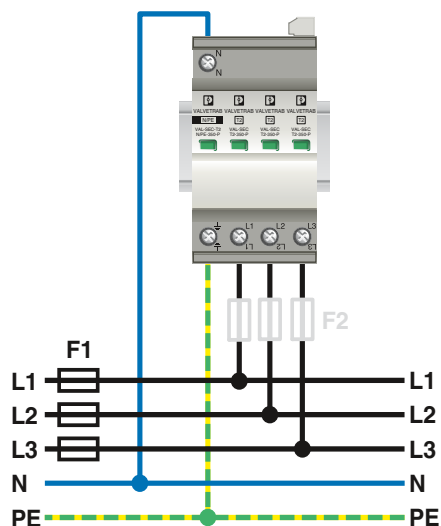

Technical characteristics

Typical installation location In sub-distributions or level distributions upstream of the RCD

Lightning protection zone LPZ 0<sub>B</sub> → LPZ 1/LPZ 1 → LPZ 2 transition

Coordination Coordination with type 1 and type 3 arresters of the SEC family is guaranteed

Connecting cables

- The required conductor cross sections must be taken from the tables
- Lay the connecting cables as short as possible, without loops, and with the largest possible bending radii

Backup fuses

- Can be used without backup fuse in branch wiring up to 315 A gG
- For backup fuses > 160 A, make sure the connecting cables are grounded and short-circuit-proof.  
Recommendation: use cables with increased temperature stability, such as VPE/EPR-insulated cables.
- If the surge protection fuse needs to be selective to the upstream installation, a separate F2 backup fuse is required. Once the F2 has tripped, there is no more surge protection for the system.
- Can be used without backup fuse in through wiring up to 63 A gG

Branch wiring

F1 A gG	F2 A gG	S <sub>L</sub> = S <sub>N</sub> mm <sup>2</sup>	S <sub>PE(N)</sub> mm <sup>2</sup>
25		6	6
35		6	6
40		6	6
50		6	6
63		10	10
80		10	10
100		16	16
125		16	16
160		16	16
200		16	16
250		16	16
315		16	16
> 315	≤ 315	16	16

Through wiring

F1 A gG	S <sub>L</sub> = S <sub>N</sub> mm <sup>2</sup>	S <sub>PE(N)</sub> mm <sup>2</sup>
25	6	6
35	6	6
40	6	6
50	10	10
63	10	10

Remote signaling data

	U <sub>max</sub>	I <sub>max</sub>
AC	250 V	1 A
AC	125 V (UL)	1 A (UL)
DC	125 V	0.2 A
DC	30 V	1 A
0.14 mm <sup>2</sup> to 1.5 mm <sup>2</sup>		

### Type 3 protection for the power supply

#### PLT-SEC

Through wiring in the TN-S network and branch wiring in the TN-S network

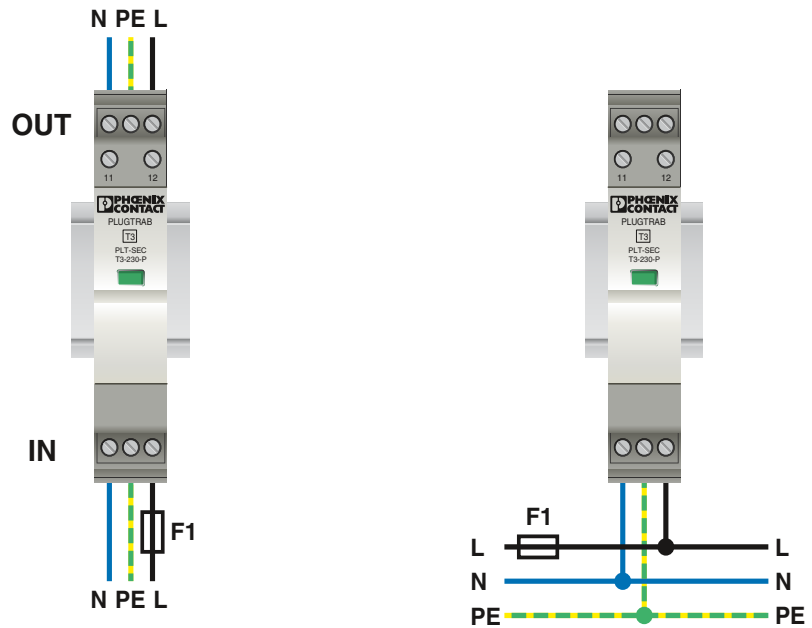

#### Technical characteristics

Typical installation location Upstream of the end device to be protected

Lightning protection zone transition LPZ 2 → LPZ 3

Coordination Coordination with type 2 arresters of the SEC family is guaranteed

Connection

- Max. conductor cross section 4 mm<sup>2</sup> solid and 2.5 mm<sup>2</sup> stranded
- The maximum load current  $I_L$  is 26 A for through wiring

Backup fuses

Can be used without backup fuse for prospective short-circuit currents up to 1500 A

- The integrated overcurrent protection is selective to upstream fuses  $F1 \geq 16 \text{ A gG}$
- For backup fuses  $> 40 \text{ A}$ , make sure the connecting cables are grounded and short-circuit-proof. Recommendation: use cables with increased temperature stability, such as VPE/EPR-insulated cables.

#### Remote signaling data

	$U_{\max}$	$I_{\max}$
AC	250 V	3 A
DC	125 V	0.2 A
DC	30 V	1 A
0.2 mm <sup>2</sup> to 2.5 mm <sup>2</sup>		

## Type 2 protection for the power supply

## VAL-CP-RCD

Branch wiring in the TN-S network

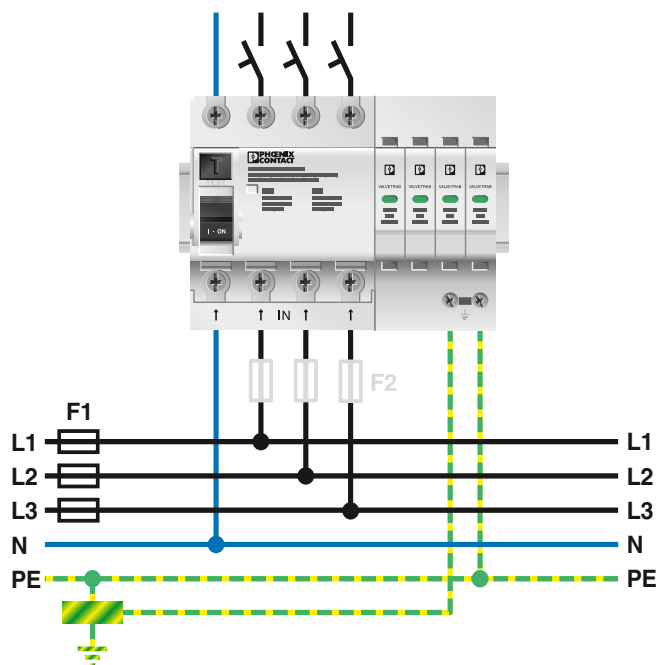

## Technical characteristics

Typical installation location In sub-distributions in place of an RCD

Lightning protection zone transition LPZ 0<sub>B</sub> → LPZ 1/LPZ 1 → LPZ 2

Coordination Coordination with type 1 and type 3 arresters of the SEC family is guaranteed

RCD The RCD used is a type A/type A selective

Connection

- The conductor cross sections are based on the upstream F1 overcurrent protection device
- $F1 \leq 50 \text{ A} \rightarrow 6 \text{ mm}^2$
- $F1 > 50 \text{ A} \rightarrow 10 \text{ mm}^2$
- Lay the connecting cables as short as possible, without loops, and with the largest possible bending radii
- The maximum load current  $I_L$  is 40 A

Backup fuses

- Can be used without backup fuse in branch and through wiring up to 63 A gG

Products in the catalog – Page 51

# Surge protection and interference suppression filters

## Surge protection for the power supply

### Type 2 protection for the power supply

#### VAL-CP-MCB

Branch wiring in the TN-S network

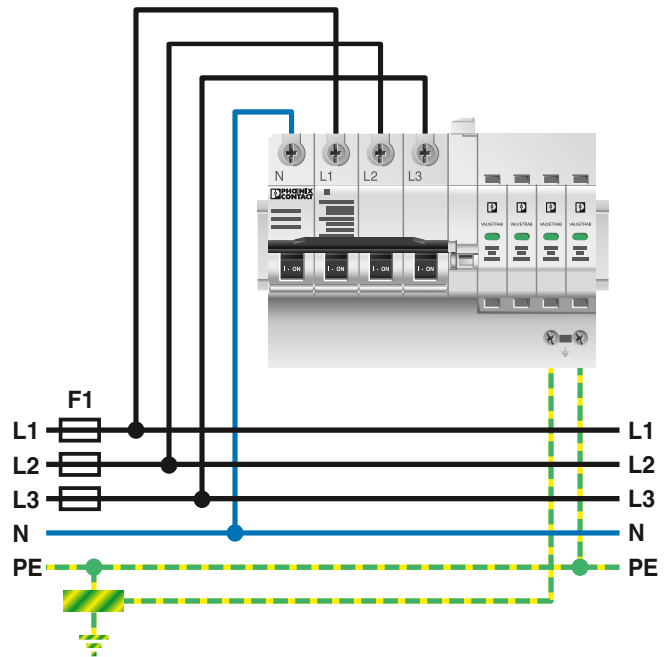

#### Technical characteristics

Typical installation location In sub-distributions or level distributions upstream of the RCD

Lightning protection zone LPZ 0<sub>B</sub> → LPZ 1 / LPZ 1 → LPZ 2 transition

Coordination Coordination with type 1 and type 3 arresters of the SEC family is guaranteed

Connecting cables

- The required conductor cross sections must be taken from the table
- Lay the connecting cables as short as possible, without loops, and with the largest possible bending radii

Backup fuses

- Can be used without backup fuse in branch wiring
- The integrated overcurrent protection is selective to upstream fuses  
F1 ≥ 63 A gG

Products in the catalog Page 53

#### Branch wiring

F1 A gG	S <sub>L</sub> = S <sub>N</sub> mm <sup>2</sup>	S <sub>↓</sub> mm <sup>2</sup>	S <sub>PEN</sub> mm <sup>2</sup>
63	10	10	10
80	10	10	10
100	16	16	16
125	16	16	16
160	25	16	16
200	25	16	16

#### Remote signaling data

	U <sub>max</sub>	I <sub>max</sub>
AC	250 V	2 A
DC	250 V	0.05 A
0.14 mm <sup>2</sup> to 1.5 mm <sup>2</sup>		

## Type 3 protection for the power supply

## BLOCKTRAB BT-1S



Universal in the end device



Surface installations

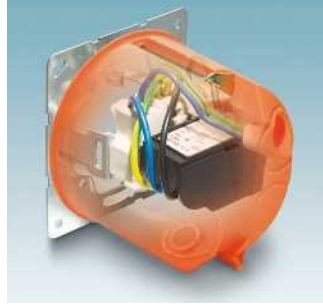

Installation boxes



Distributions

### Technical characteristics

Typical installation location Upstream of the end device to be protected

Lightning protection zone transition LPZ 2 → LPZ 3

Coordination Coordination with type 2 arresters of the SEC family is guaranteed

Connection

- Maximum conductor cross section = 2.5 mm<sup>2</sup>
- The maximum load current  $I_L$  is 16 A

Backup fuses

- Can be used without backup fuse up to MCB B-16 A

Products in the catalog Page 54



### Intelligent and systematic surge protection – PLUGTRAB PT-IQ

The PLUGTRAB PT-IQ product range is the first to offer predictive function monitoring for surge protective devices in the context of measurement and control technology. Boasting a whole range of additional features, the new surge protection system is a real highlight from Phoenix Contact.

### Always know what is happening – predictive monitoring

The individual components of the protective devices are permanently monitored. When the performance limit has been reached as a result of frequent surge voltages, this is indicated by the yellow status symbol. The arrester continues to function and your system is still protected. However, replacement of the protective plug is recommended. This ensures you are informed even earlier and can replace your surge protection before the protective plug is overloaded (red signal). Furthermore, if you use the remote signaling option, you can check how well your system is being protected from anywhere and at any time.

### Permanent and error-free installation

The PLUGTRAB PT-IQ minimizes the amount of wiring required. This is made possible by the DIN rail connector (TBUS), which is easily clipped onto the DIN rail. A controller handles the distribution of the power supply and implements remote signaling of all connected surge protective devices via the TBUS. All you then have to do is install the surge protective devices on the TBUS – and you're done! The plug and base element are coded to avoid installation errors during replacement.

### Unlimited expansion

The controller monitors all arresters which are connected to the controller via the TBUS. You can bridge the TBUS across DIN rails to monitor even more protective devices. After 28 protective devices, an additional controller must be installed to supply voltage. Remote signaling can be performed from any controller in the system.

### Other surge protective devices

PLUGTRAB PT are plug-in arresters without remote signaling, also with switching variants for intrinsically safe signal circuits.

The multi-stage modular terminal blocks in the TERMITRAB or LINETRAB product ranges have an overall width of just 6.2 mm yet are able to offer protection for up to four signal wires.

As they are installed directly on measuring sensors, the SURGETRAB screw connection modules are able to provide reliable protection against transients even in EX-i and Ex-d applications.

The products in the COMTRAB modular range have been designed specifically for use in marshalling panels.

**i** Your web code: #0144

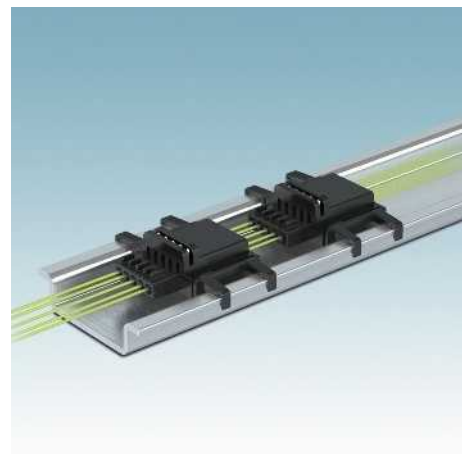

### Group indication

- Green: protective device OK
- Yellow: performance limit reached, replacement recommended
- Red: protective device overloaded, replace

### Multi-stage remote signaling

Connect the remote signaling to the controller that acts as a supply and remote signaling module (one-off connection operation). The status is output according to the priority as red, yellow or green. This ensures you always know what is happening and can always keep an eye on your system's protection.

### TBUS DIN rail connector

The DIN rail connector (TBUS) supplies voltage to the protection modules and forwards the status of each individual arrester to the controller. You benefit from the reduced wiring costs and can implement surge protection quickly without errors.



### For Ex zone 2

With the PLUGTRAB PT-IQ Ex protective devices, it is possible for the first time to install protective devices with multi-stage monitoring and remote signaling directly in Ex zone 2. The intrinsically safe protective circuits can be led up to Ex zone 0.

### Narrow arresters

The narrow TERMITRAB modular terminal blocks have an overall width of just 6.2 mm. Some offer multi-stage protective circuits for Ex and non-Ex applications.

### Special systems

Implement protection in the field directly at the measuring sensor with SURGETRAB screw connection modules.

# Surge protection and interference suppression filters

## Surge protection for MCR technology

The selection of surge protective devices for measurement and control technology depends on several factors. The protective circuit required is primarily determined by the type of signal circuit. Accordingly, this distinction is made in the first few columns of the adjacent table. In the case of binary switching signals, a distinction must then be made between grounded and non-grounded operation. Further selection criteria concern the design of the housing. Both the connection technology and space requirements must suit the installation environment. Two-piece modules comprising a plug and base element provide convenience. In the event of maintenance, it is therefore not necessary to access the installation. Using the corresponding selection criteria, the selection guide helps you find the right product quickly and easily.

Explanation of the IEC categories		
LPZ	Test category for SPD according to IEC 61643-21	Test class for SPD according to IEC 61643-11
0/1	D1	I
1/2	C2	II
2/3	C1	III











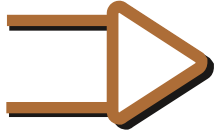



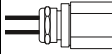





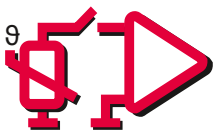



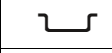







Data for fault analysis according to IEC 61508 is available on the Internet.

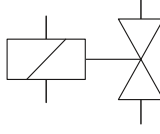

### Note

Products bearing this stamp (plug elements) can be tested with the CHECKMASTER.

Signal		Signal properties		Mounting	Connection technology
	Standard signal 0(4) to 20 mA	Signal isolated from ground	non-Ex		Push-in
					Screw
					Spring-cage
					Spring-cage
					Cables
					Screw
					Screw
					Spring-cage
					Cables
					0 to 10 V
					Screw
	Temperature measurement, e.g., Pt 100 (impedance-sensitive)	Signal isolated from ground	non-Ex		Screw
					Spring-cage
					Screw
					Screw
					Cables
	Digital IN 24 V	Common reference conductor isolated from ground	non-Ex		Push-in
					Screw
					Spring-cage
					Spring-cage
		Common reference conductor directly grounded	non-Ex		Push-in
					Screw
					Spring-cage
					Spring-cage
	Digital OUT 24 V (actuators)	Common reference conductor isolated from ground	non-Ex		Push-in
					Screw
					Screw
					Spring-cage
		Cmn. ref. conductor directly grounded	non-Ex		Push-in
					Screw



	IEC category	State monitoring	Plug-in capability	Signal isolator	Protected wires	Arrester	Order No.	Page
	D1/C2/C1	✓	✓		4	PT-IQ-2X2-24DC-PT	2801263	76
	D1/C2/C1	✓	✓		4	PT-IQ-2X2-24DC-UT	2800980	76
	D1/C2/C1				2	TT-ST-2-PE-24DC	2858878	96
	D1/C2/C1			✓	2	TT-ST-M-2-PE-24DC	2858904	96
	D1/C2/C1				2	S-PT-1X2-24DC-1/2"	2882569	98
	D1/C2/C1	✓	✓		4	PT-IQ-2X2-EX-24DC-UT	2801513	81
	D1/C2/C1		✓		4	PT 2XEX(I)-24DC-ST & PT 2XEX(I)-BE	2838225 & 2839279	89
	D1/C2/C1			✓	2	TT-ST-M-EX(I)-24DC	2859424	97
	D1/C2/C1				2	S-PT-EX(I)-24DC-1/2"	2882572	98
	D1/C2/C1	✓	✓		2	PT-IQ-1x2-12DC-PT	2801253	74
	D1/C2/C1	✓	✓		2	PT-IQ-1x2-12DC-UT	2800793	74
	D1/C2/C1		✓		4	PT 4-24DC-ST & PT 4-BE	2839240 & 2839402	86
	D1/C2/C1				2	TT-ST-2-PE/S2-24DC	2801458	97
	D1/C2/C1		✓		4	PT 4-EX(I)24DC-ST & PT 4-EX(I)-BE	2839253 & 2839486	89
	D1/C2/C1				4	LIT 4-24	2804678	93
	D1/C2/C1				2	S-PT-EX-24DC-1/2"	2800035	99
	D1/C2/C1	✓	✓		5	PT-IQ-4X1+F-24DC-PT	2801272	77
	D1/C2/C1	✓	✓		5	PT-IQ-4X1+F-24DC-UT	2800983	77
	D1/C2/C1				2	TT-ST-2/2-24DC	2858881	96
	D1/C2/C1			✓	2	TT-ST-M-2/2-24DC	2858917	96
	D1/C2/C1	✓	✓		5	PT-IQ-4X1-24DC-PT	2801271	77
	D1/C2/C1	✓	✓		5	PT-IQ-4X1-24DC-UT	2800982	77
	D1/C2/C1				2	TT-ST-2/2-24DC	2858881	96
	D1/C2/C1			✓	2	TT-ST-M-2/2-24DC	2858917	96
	D1/C2/C1	✓	✓		5	PT-IQ-4X1+F-24DC-PT	2801272	77
	D1/C2/C1	✓	✓		5	PT-IQ-4X1+F-24DC-UT	2800983	77
	D1/C2/C1		✓		4	PT 4-F-ST & PT4-BE	2858441 & 2839402	88
	D1/C2/C1				2	TT-ST-2-PE/S2-24DC	2801458	97
	D1/C2/C1	✓	✓		5	PT-IQ-4X1-24DC-PT	2801271	77
	D1/C2/C1	✓	✓		5	PT-IQ-4X1-24DC-UT	2800982	77

# Surge protection and interference suppression filters

## Surge protection for MCR technology

### PLUGTRAB PT-IQ for one double wire and 2-wire

- Multi-stage status monitoring
- Group indication via supply and remote signaling module
- Multi-stage, floating remote signaling
- System supplied via DIN rail bus
- Up to 28 protection modules per supply module
- Maximum ease of maintenance, thanks to the two-piece design
- Plugs are coded
- Impedance-neutral disconnection of plug for maintenance purposes
- PT-IQ...-UT base element with screw connection technology
- PT-IQ...-PT base element with push-in connection technology
- Base element remains an integral part of the installation
- Corresponding replacement plugs can be found on our website

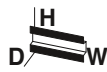

Controller for supply and remote signaling



Double wire (loop), floating, connection 9/10 grounded directly, e.g., for 4 ... 20 mA current loop

ERC

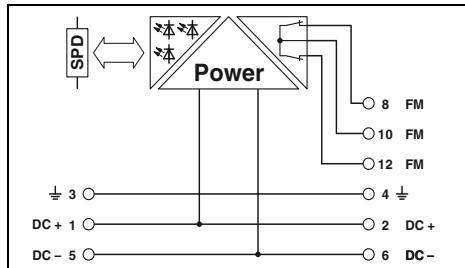

ERC

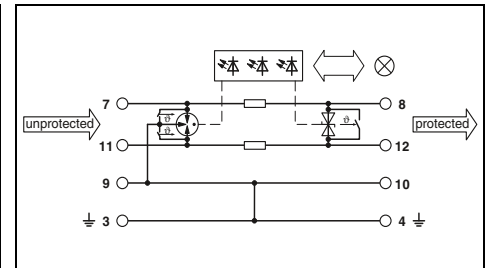

#### Technical data

Electrical data	
IEC test classification/EN type	-
Maximum continuous operating voltage $U_c$	-
Impulse discharge curr. $I_{imp}$ (10/350) $\mu$ s	Per path
Nominal current $I_N$	max. 130 mA (24 V DC)
Nominal discharge current $I_n$ (8/20) $\mu$ s	Core-Core / Core-Ground
Total surge current (8/20) $\mu$ s	- / -
Protection level $U_p$	Core-Core
	Core-Ground
Resistance per path	-
General data	
PT-IQ...PT dimensions W / H / D	17.7 mm / 109.3 mm / 77.5 mm
PT-IQ...UT dimensions W / H / D	17.7 mm / 91.1 mm / 77.5 mm
Connection data, push-in solid / stranded with ferrule / AWG	0.2 ... 4 mm <sup>2</sup> / 0.2 ... 2.5 mm <sup>2</sup> / 24 - 12
Connection data solid / stranded with ferrule / AWG	0.2 ... 4 mm <sup>2</sup> / 0.2 ... 2.5 mm <sup>2</sup> / 24 - 12
Temperature range	-40°C ... 70°C
Degree of protection in acc. with IEC 60529/EN 60529	IP20
Inflammability class in acc. with UL 94	V0
Test standards	EN 61000-6-2 / EN 61000-6-3/A1 / EN 60950-1/A2
Remote indication contact	2x N/C contacts
Connection data solid / AWG	0.2 ... 4 mm <sup>2</sup> / 24 - 14
Max. operating voltage	30 V AC (50 - 60 Hz, non-Ex) / 50 V DC (non-Ex)
Max. operating current	1 A (up to 50°C, non-Ex) / 200 mA (up to 70°C, non-Ex)

#### Technical data

... 5DC	... 12DC	... 24DC	... 48DC
C1 / C2 / C3 / D1	C1 / C2 / C3 / D1	C1 / C2 / C3 / D1	C1 / C2 / C3 / D1
6 V DC / 4 V AC	15 V DC / 10 V AC	30 V DC / 21 V AC	53 V DC / 37 V AC
2.5 kA	2.5 kA	2.5 kA	2.5 kA
1000 mA (45°C)	1000 mA (45°C)	1000 mA (45°C)	300 mA (45°C)
10 kA / 10 kA 20 kA	10 kA / 10 kA 20 kA	10 kA / 10 kA 20 kA	10 kA / 10 kA 20 kA
≤ 25 V (C3 - 25 A)	≤ 35 V (C3 - 25 A)	≤ 55 V (C3 - 25 A)	≤ 90 V (C3 - 25 A)
≤ 700 V (C3 - 25 A)	≤ 700 V (C3 - 25 A)	≤ 700 V (C3 - 25 A)	≤ 700 V (C3 - 25 A)
1.2 Ω	1.2 Ω	1.2 Ω	1.2 Ω
	17.7 mm / 109.3 mm / 77.5 mm		17.7 mm / 91.1 mm / 77.5 mm
			0.2 ... 4 mm <sup>2</sup> / 0.2 ... 2.5 mm <sup>2</sup> / 24 - 12
			0.2 ... 4 mm <sup>2</sup> / 0.2 ... 2.5 mm <sup>2</sup> / 24 - 12
		-40°C ... 70°C	
		IP20	
		V0	
		EN 61000-6-2 / EN 61000-6-3/A1 / EN 60950-1/A2	EN 61643-21/A1 / IEC 61643-21/A1 / EN 61000-6-2 / EN 61000-6-3/A1 / EN 61000-6-3
			Via TBUS
			- / -
			- / -

#### Ordering data

Description	Voltage $U_N$	Type	Order No.	Pcs. / Pkt.
<b>PLUGTRAB supply module</b>				
with screw connection technology	24 V DC	PT-IQ-PTB-UT	2800768	1
with push-in connection technology	24 V DC	PT-IQ-PTB-PT	2801296	1
<b>MCR-PLUGTRAB, with screw connection technology</b>				
	5 V DC			
	12 V DC			
	24 V DC			
	48 V DC			
<b>MCR-PLUGTRAB, with push-in connection technology</b>				
	5 V DC			
	12 V DC			
	24 V DC			
	48 V DC			

#### Ordering data

Type	Order No.	Pcs. / Pkt.
PT-IQ-1X2-5DC-UT	2800791	1
PT-IQ-1X2-12DC-UT	2800793	1
PT-IQ-1X2-24DC-UT	2800976	1
PT-IQ-1X2-48DC-UT	2800978	1
PT-IQ-1X2-5DC-PT	2801251	1
PT-IQ-1X2-12DC-PT	2801253	1
PT-IQ-1X2-24DC-PT	2801255	1
PT-IQ-1X2-48DC-PT	2801257	1



**SIL**  
evaluated  
IEC 61508



Double wire (loop), floating, connection 9/10 grounded via gas-filled surge arrester, e.g., for 4 ... 20 mA current loop



**SIL**  
evaluated  
IEC 61508



2-wire with common reference potential, connection 9/10 grounded directly, e.g., for binary signals



**SIL**  
evaluated  
IEC 61508



2-wire with common reference potential, connection 9/10 grounded via gas-filled surge arrester, e.g., for binary signals

ERC

ERC

ERC

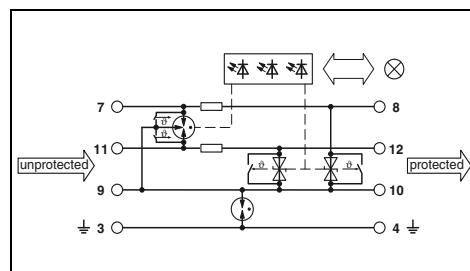
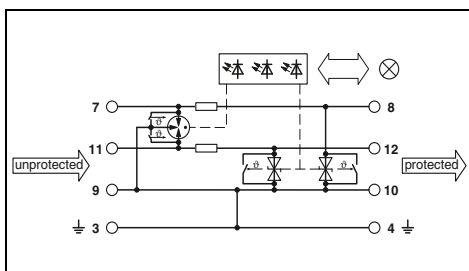
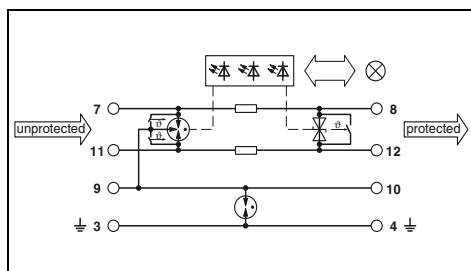

### Technical data

... 5DC	... 12DC	... 24DC	... 48DC
C1 / C2 / C3 / D1	C1 / C2 / C3 / D1	C1 / C2 / C3 / D1	C1 / C2 / C3 / D1
6 V DC / 4 V AC	15 V DC / 10 V AC	30 V DC / 21 V AC	53 V DC / 37 V AC
2.5 kA	2.5 kA	2.5 kA	2.5 kA
1000 mA (45°C)	1000 mA (45°C)	1000 mA (45°C)	300 mA (45°C)
10 kA / 10 kA	10 kA / 10 kA	10 kA / 10 kA	10 kA / 10 kA
20 kA	20 kA	20 kA	20 kA
≤ 25 V (C3 - 25 A)	≤ 35 V (C3 - 25 A)	≤ 55 V (C3 - 25 A)	≤ 90 V (C3 - 25 A)
≤ 1000 V (C3 - 25 A)	≤ 1000 V (C3 - 25 A)	≤ 1000 V (C3 - 25 A)	≤ 1000 V (C3 - 25 A)
1.2 Ω	1.2 Ω	1.2 Ω	1.2 Ω

17.7 mm / 109.3 mm / 77.5 mm  
17.7 mm / 91.1 mm / 77.5 mm  
0.2 ... 4 mm<sup>2</sup> / 0.2 ... 2.5 mm<sup>2</sup> / 24 - 12  
0.2 ... 4 mm<sup>2</sup> / 0.2 ... 2.5 mm<sup>2</sup> / 24 - 12

-40°C ... 70°C  
IP20  
V0

EN 61643-21/A1 / IEC 61643-21/A1 / EN 61000-6-2 / EN 61000-6-2/A1 / EN 61000-6-3

Via TBUS

- / -  
-  
- / -

### Technical data

... 5DC	... 12DC	... 24DC	... 48DC
C1 / C2 / C3 / D1	C1 / C2 / C3 / D1	C1 / C2 / C3 / D1	C1 / C2 / C3 / D1
6 V DC / 4 V AC	15 V DC / 10 V AC	30 V DC / 21 V AC	53 V DC / 37 V AC
2.5 kA	2.5 kA	2.5 kA	2.5 kA
1000 mA (45°C)	1000 mA (45°C)	1000 mA (45°C)	300 mA (45°C)
- / 10 kA	- / 10 kA	- / 10 kA	- / 10 kA
20 kA	20 kA	20 kA	20 kA
≤ 25 V (C3 - 25 A)	≤ 35 V (C3 - 25 A)	≤ 55 V (C3 - 25 A)	≤ 90 V (C3 - 25 A)
1.2 Ω	1.2 Ω	1.2 Ω	1.2 Ω

17.7 mm / 109.3 mm / 77.5 mm  
17.7 mm / 91.1 mm / 77.5 mm  
0.2 ... 4 mm<sup>2</sup> / 0.2 ... 2.5 mm<sup>2</sup> / 24 - 12  
0.2 ... 4 mm<sup>2</sup> / 0.2 ... 2.5 mm<sup>2</sup> / 24 - 12

-40°C ... 70°C  
IP20  
V0

EN 61643-21/A1 / IEC 61643-21/A1 / EN 61000-6-2 / EN 61000-6-2/A1 / EN 61000-6-3

Via TBUS

- / -  
-  
- / -

### Technical data

... 5DC	... 12DC	... 24DC	... 48DC
C1 / C2 / C3 / D1	C1 / C2 / C3 / D1	C1 / C2 / C3 / D1	C1 / C2 / C3 / D1
6 V DC / 4 V AC	15 V DC / 10 V AC	30 V DC / 21 V AC	53 V DC / 37 V AC
2.5 kA	2.5 kA	2.5 kA	2.5 kA
1000 mA (45°C)	1000 mA (45°C)	1000 mA (45°C)	300 mA (45°C)
- / 10 kA	- / 10 kA	- / 10 kA	- / 10 kA
20 kA	20 kA	20 kA	20 kA
≤ 950 V (C3 - 50 A)	≤ 810 V (C3 - 25 A)	≤ 780 V (C3 - 25 A)	≤ 850 V (C3 - 25 A)
1.2 Ω	1.2 Ω	1.2 Ω	1.2 Ω

17.7 mm / 109.3 mm / 77.5 mm  
17.7 mm / 91.1 mm / 77.5 mm  
0.2 ... 4 mm<sup>2</sup> / - / 24 - 12  
0.2 ... 4 mm<sup>2</sup> / 0.2 ... 2.5 mm<sup>2</sup> / 24 - 12

-40°C ... 70°C  
IP20  
V0

EN 61643-21/A1 / IEC 61643-21/A1 / EN 61000-6-2 / EN 61000-6-2/A1 / EN 61000-6-3

Via TBUS

- / -  
-  
- / -

### Ordering data

Type	Order No.	Pcs. / Pkt.
PT-IQ-1X2+F-5DC-UT	2800792	1
PT-IQ-1X2+F-12DC-UT	2800975	1
PT-IQ-1X2+F-24DC-UT	2800977	1
PT-IQ-1X2+F-48DC-UT	2800979	1
PT-IQ-1X2+F-5DC-PT	2801252	1
PT-IQ-1X2+F-12DC-PT	2801254	1
PT-IQ-1X2+F-24DC-PT	2801256	1
PT-IQ-1X2+F-48DC-PT	2801258	1

### Ordering data

Type	Order No.	Pcs. / Pkt.
PT-IQ-2X1-5DC-UT	2800778	1
PT-IQ-2X1-12DC-UT	2800780	1
PT-IQ-2X1-24DC-UT	2800787	1
PT-IQ-2X1-48DC-UT	2800789	1
PT-IQ-2X1-5DC-PT	2801243	1
PT-IQ-2X1-12DC-PT	2801245	1
PT-IQ-2X1-24DC-PT	2801247	1
PT-IQ-2X1-48DC-PT	2801249	1

### Ordering data

Type	Order No.	Pcs. / Pkt.
PT-IQ-2X1+F-5DC-UT	2800779	1
PT-IQ-2X1+F-12DC-UT	2800781	1
PT-IQ-2X1+F-24DC-UT	2800788	1
PT-IQ-2X1+F-48DC-UT	2800790	1
PT-IQ-2X1+F-5DC-PT	2801244	1
PT-IQ-2X1+F-12DC-PT	2801246	1
PT-IQ-2X1+F-24DC-PT	2801248	1
PT-IQ-2X1+F-48DC-PT	2801250	1

# Surge protection and interference suppression filters

## Surge protection for MCR technology

### PLUGTRAB PT-IQ for two double wires or 4-wire

- Multi-stage status monitoring
- Group indication via supply and remote signaling module
- Multi-stage, floating remote signaling
- System supplied via DIN rail bus
- Up to 28 protection modules per supply module
- Maximum ease of maintenance, thanks to the two-piece design
- Plugs are coded
- Impedance-neutral disconnection of plug for maintenance purposes
- PT-IQ...-UT base element with screw connection technology
- PT-IQ...-PT base element with push-in connection technology
- Base element remains an integral part of the installation
- Corresponding replacement plugs can be found on our website



Controller for supply and remote signaling



2 double wires (loops), floating, connection 9/10 grounded directly, e.g., for 4 ... 20 mA current loop

ERIC

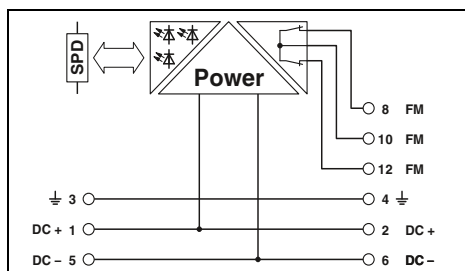

ERIC

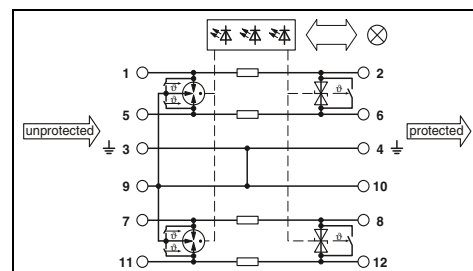

#### Technical data

Electrical data	
IEC test classification/EN type	-
Maximum continuous operating voltage $U_c$	-
Impulse discharge curr. $I_{mp}$ (10/350) $\mu$ s	Per path -
Nominal current $I_N$	max. 130 mA (24 V DC)
Nominal discharge current $I_n$ (8/20) $\mu$ s	Core-Core / Core-Ground - / -
Total surge current (8/20) $\mu$ s	-
Protection level $U_p$	Core-Core Core-Ground
Resistance per path	-
General data	
PT-IQ...PT dimensions W / H / D	17.7 mm / 109.3 mm / 77.5 mm
PT-IQ...UT dimensions W / H / D	17.7 mm / 91.1 mm / 77.5 mm
Connection data, push-in solid / stranded with ferrule / AWG	0.2 ... 4 mm <sup>2</sup> / 0.2 ... 2.5 mm <sup>2</sup> / 24 - 12
Connection data solid / stranded with ferrule / AWG	0.2 ... 4 mm <sup>2</sup> / 0.2 ... 2.5 mm <sup>2</sup> / 24 - 12
Temperature range	-40°C ... 70°C
Degree of protection in acc. with IEC 60529/EN 60529	IP20
Inflammability class in acc. with UL 94	V0
Test standards	EN 61000-6-2 / EN 61000-6-3/A1 / EN 60950-1/A2
Remote indication contact	2x N/C contacts
Connection data solid / AWG	0.2 ... 4 mm <sup>2</sup> / 24 - 14
Max. operating voltage	30 V AC (50 - 60 Hz, non-Ex) / 50 V DC (non-Ex)
Max. operating current	1 A (up to 50°C, non-Ex) / 200 mA (up to 70°C, non-Ex)

#### Technical data

... 5DC	... 12DC	... 24DC	... 48DC
C1 / C2 / C3 / D1	C1 / C2 / C3 / D1	C1 / C2 / C3 / D1	C1 / C2 / C3 / D1
6 V DC / 4 V AC / 2.5 kA	15 V DC / 10 V AC / 700 mA (50°C)	30 V DC / 21 V AC / 700 mA (50°C)	53 V DC / 37 V AC / 300 mA
10 kA / 10 kA / 20 kA	10 kA / 10 kA / 20 kA	10 kA / 10 kA / 20 kA	10 kA / 10 kA / 20 kA
≤ 25 V (C3 - 25 A) / ≤ 700 V (C3 - 25 A) / 1.2 Ω	≤ 35 V (C3 - 25 A) / ≤ 700 V (C3 - 25 A) / -	≤ 55 V (C3 - 25 A) / ≤ 700 V (C3 - 25 A) / 1.2 Ω	≤ 90 V (C3 - 25 A) / ≤ 700 V (C3 - 25 A) / 1.2 Ω
17.7 mm / 109.3 mm / 77.5 mm	17.7 mm / 91.1 mm / 77.5 mm	0.2 ... 4 mm <sup>2</sup> / - / -	0.2 ... 4 mm <sup>2</sup> / 24 - 12
-40°C ... 70°C	-40°C ... 70°C	IP20	V0
EN 61000-6-2 / EN 61000-6-3/A1 / EN 60950-1/A2	EN 61643-21/A1 / IEC 61643-21/A1 / EN 61000-6-2 / EN 61000-6-2/A1 / EN 61000-6-3	Via TBUS	- / -

#### Ordering data

Description	Voltage $U_N$
<b>PLUGTRAB supply module</b>	
with screw connection technology	24 V DC
with push-in connection technology	24 V DC
<b>MCR-PLUGTRAB, with screw connection technology</b>	
	5 V DC
	12 V DC
	24 V DC
	48 V DC
<b>MCR-PLUGTRAB, with push-in connection technology</b>	
	5 V DC
	12 V DC
	24 V DC
	48 V DC

Type	Order No.	Pcs. / Pkt.
PT-IQ-PTB-UT	2800768	1
PT-IQ-PTB-PT	2801296	1

#### Ordering data

Type	Order No.	Pcs. / Pkt.
PT-IQ-2X2-5DC-UT	2800807	1
PT-IQ-2X2-12DC-UT	2800984	1
PT-IQ-2X2-24DC-UT	2800980	1
PT-IQ-2X2-48DC-UT	2800986	1
PT-IQ-2X2-5DC-PT	2801259	1
PT-IQ-2X2-12DC-PT	2801261	1
PT-IQ-2X2-24DC-PT	2801263	1
PT-IQ-2X2-48DC-PT	2801265	1



**SIL**  
evaluated  
IEC 61508



**2 double wires (loops), floating, connection 9/10 grounded via gas-filled surge arrester, e.g., for 4 ... 20 mA current loop**



**SIL**  
evaluated  
IEC 61508



**4-wire with common reference potential, connection 9/10 grounded directly, e.g., for binary signals**



**SIL**  
evaluated  
IEC 61508



**4-wire with common reference potential, connection 9/10 grounded via gas-filled surge arrester, e.g., for binary signals**

ERC

ERC

ERC

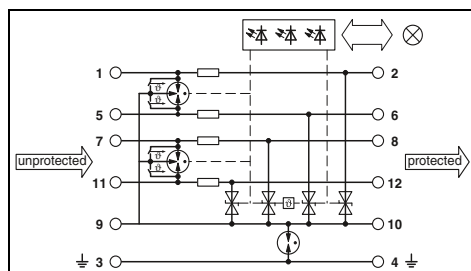
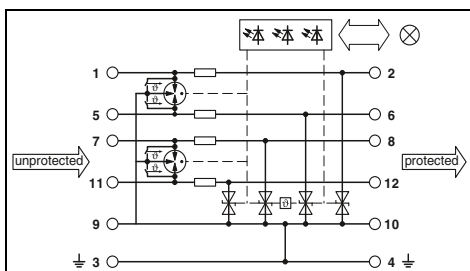
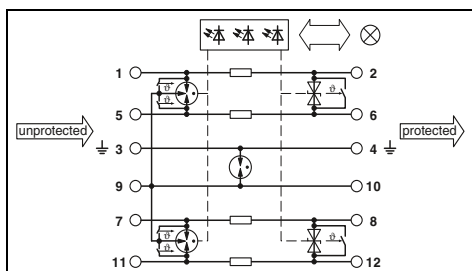

### Technical data

... 5DC	... 12DC	... 24DC	... 48DC
C1 / C2 / C3 / D1	C1 / C2 / C3 / D1	C1 / C2 / C3 / D1	C1 / C2 / C3 / D1
6 V DC / 4 V AC	15 V DC / 10 V AC	30 V DC / 21 V AC	53 V DC / 37 V AC
2.5 kA	-	2.5 kA	2.5 kA
700 mA (50°C)	700 mA (50°C)	700 mA (50°C)	300 mA
10 kA / 10 kA / 20 kA	10 kA / 10 kA / 20 kA	10 kA / 10 kA / 20 kA	10 kA / 10 kA / 20 kA
≤ 25 V (C3 - 25 A)	≤ 35 V (C3 - 25 A)	≤ 55 V (C3 - 25 A)	≤ 90 V (C3 - 25 A)
≤ 1000 V (C3 - 25 A)	≤ 1000 V (C3 - 25 A)	≤ 1000 V (C3 - 25 A)	≤ 1000 V (C3 - 25 A)
1.2 Ω	-	1.2 Ω	1.2 Ω

17.7 mm / 109.3 mm / 77.5 mm  
17.7 mm / 91.1 mm / 77.5 mm  
0.2 ... 4 mm<sup>2</sup> / - / -

0.2 ... 4 mm<sup>2</sup> / 0.2 ... 2.5 mm<sup>2</sup> / 24 - 12

-40°C ... 70°C

IP20

V0

EN 61643-21/A1 / IEC 61643-21/A1 / EN 61000-6-2 / EN 61000-6-2/A1 / EN 61000-6-3

Via TBUS

- / -

-

- / -

### Technical data

... 5DC	... 12DC	... 24DC	... 48DC
C1 / C2 / C3 / D1	C1 / C2 / C3 / D1	C1 / C2 / C3 / D1	C1 / C2 / C3 / D1
6 V DC / 4 V AC	15 V DC / 10 V AC	30 V DC / 21 V AC	53 V DC / 37 V AC
2.5 kA	-	2.5 kA	-
700 mA (50°C)	700 mA (50°C)	700 mA (45°C)	300 mA
- / 10 kA / 20 kA	- / 10 kA / 20 kA	- / 10 kA / 20 kA	- / 10 kA / 20 kA
≤ 25 V (C3 - 25 A)	≤ 35 V (C3 - 25 A)	≤ 55 V (C3 - 25 A)	≤ 90 V (C3 - 25 A)
1.2 Ω	-	1.2 Ω	-

17.7 mm / 109.3 mm / 77.5 mm  
17.7 mm / 91.1 mm / 77.5 mm  
0.2 ... 4 mm<sup>2</sup> / - / -

0.2 ... 4 mm<sup>2</sup> / 0.2 ... 2.5 mm<sup>2</sup> / 24 - 12

-40°C ... 70°C

IP20

V0

EN 61643-21/A1 / IEC 61643-21/A1 / EN 61000-6-2 / EN 61000-6-2/A1 / EN 61000-6-3

Via TBUS

- / -

- / -

- / -

### Technical data

... 5DC	... 12DC	... 24DC	... 48DC
C1 / C2 / C3 / D1	C1 / C2 / C3 / D1	C1 / C2 / C3 / D1	C1 / C2 / C3 / D1
6 V DC / 4 V AC	15 V DC / 10 V AC	30 V DC / 21 V AC	53 V DC / 37 V AC
2.5 kA	-	2.5 kA	-
700 mA (50°C)	700 mA (50°C)	700 mA (45°C)	300 mA
- / 10 kA / 20 kA	- / 10 kA / 20 kA	- / 10 kA / 20 kA	- / 10 kA / 20 kA
≤ 950 V (C3 - 50 A)	≤ 810 V (C3 - 25 A)	≤ 780 V (C3 - 25 A)	≤ 850 V (C3 - 25 A)
1.2 Ω	-	1.2 Ω	-

17.7 mm / 109.3 mm / 77.5 mm  
17.7 mm / 91.1 mm / 77.5 mm  
0.2 ... 4 mm<sup>2</sup> / - / -

0.2 ... 4 mm<sup>2</sup> / 0.2 ... 2.5 mm<sup>2</sup> / 24 - 12

-40°C ... 70°C

IP20

V0

EN 61643-21/A1 / IEC 61643-21/A1 / EN 61000-6-2 / EN 61000-6-2/A1 / EN 61000-6-3

Via TBUS

- / -

-

- / -

### Ordering data

Type	Order No.	Pcs. / Pkt.
PT-IQ-2X2+F-5DC-UT	2800809	1
PT-IQ-2X2+F-12DC-UT	2800985	1
PT-IQ-2X2+F-24DC-UT	2800981	1
PT-IQ-2X2+F-48DC-UT	2800987	1
PT-IQ-2X2+F-5DC-PT	2801260	1
PT-IQ-2X2+F-12DC-PT	2801262	1
PT-IQ-2X2+F-24DC-PT	2801264	1
PT-IQ-2X2+F-48DC-PT	2801266	1

### Ordering data

Type	Order No.	Pcs. / Pkt.
PT-IQ-4X1-5DC-UT	2801215	1
PT-IQ-4X1-12DC-UT	2801217	1
PT-IQ-4X1-24DC-UT	2800982	1
PT-IQ-4X1-48DC-UT	2801219	1
PT-IQ-4X1-5DC-PT	2801267	1
PT-IQ-4X1-12DC-PT	2801269	1
PT-IQ-4X1-24DC-PT	2801271	1
PT-IQ-4X1-48DC-PT	2801273	1

### Ordering data

Type	Order No.	Pcs. / Pkt.
PT-IQ-4X1+F-5DC-UT	2801216	1
PT-IQ-4X1+F-12DC-UT	2801218	1
PT-IQ-4X1+F-24DC-UT	2800983	1
PT-IQ-4X1+F-48DC-UT	2801220	1
PT-IQ-4X1+F-5DC-PT	2801268	1
PT-IQ-4X1+F-12DC-PT	2801270	1
PT-IQ-4X1+F-24DC-PT	2801272	1
PT-IQ-4X1+F-48DC-PT	2801274	1

# Surge protection and interference suppression filters

## Surge protection for MCR technology

### PLUGTRAB PT-IQ for three wires or 5-wire

- Multi-stage status monitoring
- Group indication via supply and remote signaling module
- Multi-stage, floating remote signaling
- System supplied via DIN rail bus
- Up to 28 protection modules per supply module
- Maximum ease of maintenance, thanks to the two-piece design
- Plugs are coded
- Impedance-neutral disconnection of plug for maintenance purposes
- PT-IQ...-UT base element with screw connection technology
- Base element remains an integral part of the installation
- PT-IQ...-PT base element with push-in connection technology
- Corresponding replacement plugs can be found on our website



Controller for supply and remote signaling



3-wire protection for fieldbus and serial interface, connection 9/10 grounded directly

ERC

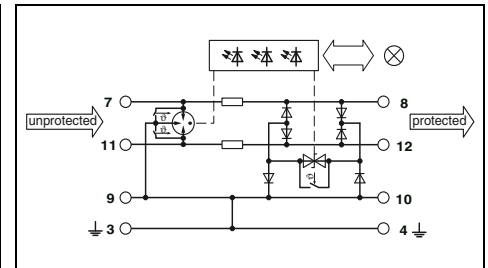
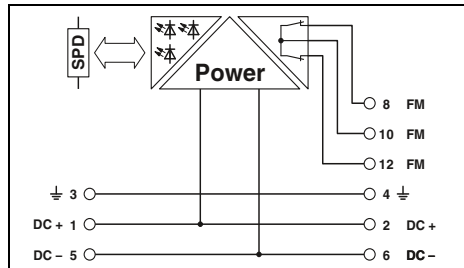

#### Technical data

Electrical data	
IEC test classification/EN type	
Maximum continuous operating voltage $U_C$	-
Impulse discharge curr. $I_{imp}$ (10/350) $\mu$ s	Per path
Nominal current $I_N$	max. 130 mA (24 V DC)
Nominal discharge current $I_n$ (8/20) $\mu$ s	-
	Core-Core / Core-Ground
Total surge current (8/20) $\mu$ s	- / -
Protection level $U_p$	-
	Core-Core
	Core-Ground
Resistance per path	-
General data	
PT-IQ...PT dimensions W / H / D	17.7 mm / 109.3 mm / 77.5 mm
PT-IQ...UT dimensions W / H / D	17.7 mm / 91.1 mm / 77.5 mm
Connection data, push-in solid / stranded with ferrule / AWG	0.2 ... 4 mm <sup>2</sup> / 0.2 ... 2.5 mm <sup>2</sup> / 24 - 12
Connection data solid / stranded with ferrule / AWG	0.2 ... 4 mm <sup>2</sup> / 0.2 ... 2.5 mm <sup>2</sup> / 24 - 12
Temperature range	-40°C ... 70°C
Degree of protection in acc. with IEC 60529/EN 60529	IP20
Inflammability class in acc. with UL 94	V0
Test standards	EN 61000-6-2 / EN 61000-6-3/A1 / EN 60950-1/A2
Remote indication contact	
Connection data solid / AWG	2x N/C contacts
Max. operating voltage	0.2 ... 4 mm <sup>2</sup> / 24 - 14
Max. operating current	30 V AC (50 - 60 Hz, non-Ex) / 50 V DC (non-Ex)
	1 A (up to 50°C, non-Ex) / 200 mA (up to 70°C, non-Ex)

#### Ordering data

Description	Voltage $U_N$	Type	Order No.	Pcs. / Pkt.
<b>PLUGTRAB supply module</b>				
with screw connection technology	24 V DC	PT-IQ-PTB-UT	2800768	1
with push-in connection technology	24 V DC	PT-IQ-PTB-PT	2801296	1
<b>MCR-PLUGTRAB, with screw connection technology</b>				
	5 V DC			
	12 V DC			
<b>MCR-PLUGTRAB, with push-in connection technology</b>				
	5 V DC			
	12 V DC			

#### Technical data

... 5DC		... 12DC	
C1 / C2 / C3 / D1		C1 / C2 / C3 / D1	
6 V DC / 4 V AC		15 V DC / 10 V AC	
2.5 kA		2.5 kA	
600 mA (40°C)		600 mA (40°C)	
10 kA / 10 kA		10 kA / 10 kA	
20 kA		20 kA	
$\leq 30$ V (C3 - 25 A)		$\leq 40$ V (C3 - 25 A)	
$\leq 30$ V (C3 - 25 A)		$\leq 90$ V (C1 - 1 kV/500 A)	
1.2 $\Omega$		1.2 $\Omega$	
		17.7 mm / 109.3 mm / 77.5 mm	
		17.7 mm / 91.1 mm / 77.5 mm	
		0.2 ... 4 mm <sup>2</sup> / 0.2 ... 2.5 mm <sup>2</sup> / 24 - 12	
		0.2 ... 4 mm <sup>2</sup> / 0.2 ... 2.5 mm <sup>2</sup> / 24 - 12	
		-40°C ... 70°C	
		IP20	
		V0	
		EN 61643-21/A1 / IEC 61643-21/A2 / EN 61000-6-2/A1 / EN 61000-6-3	
		Via TBUS	
		- / -	
		- / -	

#### Ordering data

Type	Order No.	Pcs. / Pkt.
PT-IQ-3-PB-UT	2800785	1
PT-IQ-3-HF-12DC-UT	2800786	1
PT-IQ-3-PB-PT	2801286	1
PT-IQ-3-HF-12DC-PT	2801288	1



**3-wire protection for fieldbus and serial interface, connection 9/10 grounded via gas-filled surge arrester**



**5-wire protection for fieldbus and serial interface, connection 9/10 grounded directly**



**5-wire protection for fieldbus and serial interface, connection 9/10 grounded via gas-filled surge arrester**

ERC

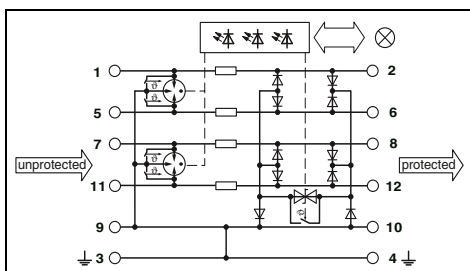
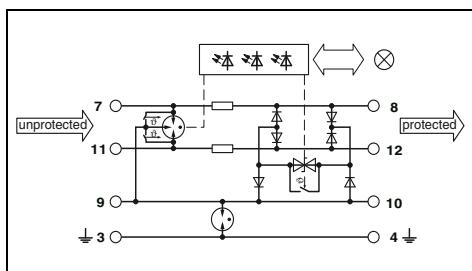

ERC

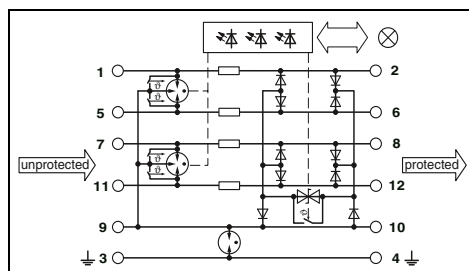

Technical data	
... 5DC	... 12DC
C1 / C2 / C3 / D1	C1 / C2 / C3 / D1
6 V DC / 4 V AC	15 V DC / 10 V AC
2.5 kA	2.5 kA
600 mA (40°C)	600 mA (40°C)
10 kA / 10 kA	10 kA / 10 kA
20 kA	20 kA
≤ 30 V (C3 - 25 A)	≤ 40 V (C3 - 25 A)
≤ 900 V (C3 - 25 A)	≤ 730 V (C1 - 1 kV/500 A)
1.2 Ω	1.2 Ω
17.7 mm / 109.3 mm / 77.5 mm	
17.7 mm / 91.1 mm / 77.5 mm	
0.2 ... 4 mm <sup>2</sup> / 0.2 ... 2.5 mm <sup>2</sup> / 24 - 12	
0.2 ... 4 mm <sup>2</sup> / 0.2 ... 2.5 mm <sup>2</sup> / 24 - 12	
-40°C ... 70°C	
IP20	
V0	
EN 61643-21/A1 / IEC 61643-21/A2 / EN 61000-6-2/A1 / EN 61000-6-3	
Via TBUS	
- / -	- / -
- / -	- / -

Technical data	
... 5DC	... 12DC
C1 / C2 / C3 / D1	C1 / C2 / C3 / D1
6 V DC / 4 V AC	15 V DC / 10 V AC
2.5 kA	2.5 kA
600 mA (40°C)	600 mA (40°C)
10 kA / 10 kA	10 kA / 10 kA
20 kA	20 kA
≤ 30 V (C3 - 25 A)	≤ 40 V (C3 - 25 A)
≤ 30 V (C3 - 25 A)	≤ 40 V (C3 - 25 A)
1.2 Ω	1.2 Ω
17.7 mm / 109.3 mm / 77.5 mm	
17.7 mm / 91 mm / 77.5 mm	
0.2 ... 4 mm <sup>2</sup> / 0.2 ... 2.5 mm <sup>2</sup> / 24 - 12	
0.2 ... 4 mm <sup>2</sup> / 0.2 ... 2.5 mm <sup>2</sup> / 24 - 12	
-40°C ... 70°C	
IP20	
V0	
EN 61643-21/A1 / IEC 61643-21/A2 / EN 61000-6-2/A1 / EN 61000-6-3	
Via TBUS	
- / -	- / -
- / -	- / -

Technical data	
... 5DC	... 12DC
C1 / C2 / C3 / D1	C1 / C2 / C3 / D1
6 V DC / 4 V AC	15 V DC / 10 V AC
2.5 kA	2.5 kA
600 mA (40°C)	600 mA (40°C)
10 kA / 10 kA	10 kA / 10 kA
20 kA	20 kA
≤ 30 V (C3 - 25 A)	≤ 40 V (C3 - 25 A)
≤ 900 V (C3 - 25 A)	≤ 900 V (C3 - 25 A)
1.2 Ω	1.2 Ω
17.7 mm / 109.3 mm / 77.5 mm	
17.7 mm / 91 mm / 77.5 mm	
0.2 ... 4 mm <sup>2</sup> / 0.2 ... 2.5 mm <sup>2</sup> / 24 - 12	
0.2 ... 4 mm <sup>2</sup> / 0.2 ... 2.5 mm <sup>2</sup> / 24 - 12	
-40°C ... 70°C	
IP20	
V0	
EN 61643-21/A1 / IEC 61643-21/A2 / EN 61000-6-2/A1 / EN 61000-6-3	
Via TBUS	
- / -	- / -
- / -	- / -

Ordering data		
Type	Order No.	Pcs. / Pkt.
PT-IQ-3-PB+F-UT	2800994	1
PT-IQ-3-HF+F-12DC-UT	2800995	1
PT-IQ-3-PB+F-PT	2801287	1
PT-IQ-3-HF+F-12DC-PT	2801289	1

Ordering data		
Type	Order No.	Pcs. / Pkt.
PT-IQ-5-HF-5DC-UT	2800797	1
PT-IQ-5-HF-12DC-UT	2800799	1
PT-IQ-5-HF-5DC-PT	2801291	1
PT-IQ-5-HF-12DC-PT	2801293	1

Ordering data		
Type	Order No.	Pcs. / Pkt.
PT-IQ-5-HF+F-5DC-UT	2800798	1
PT-IQ-5-HF+F-12DC-UT	2800801	1
PT-IQ-5-HF+F-5DC-PT	2801292	1
PT-IQ-5-HF+F-12DC-PT	2801295	1

# Surge protection and interference suppression filters

## Surge protection for MCR technology

### PLUGTRAB PT-IQ for telecommunications systems

- Multi-stage status monitoring
- Group indication via supply and remote signaling module
- Multi-stage, floating remote signaling
- System supplied via DIN rail bus
- Up to 28 protection modules per supply module
- Maximum ease of maintenance, thanks to the two-piece design
- Plugs are coded
- Impedance-neutral disconnection of plug for maintenance purposes
- Base element remains an integral part of the installation
- PT-IQ...-UT base element with screw connection technology
- PT-IQ...-PT base element with push-in connection technology
- Corresponding replacement plugs can be found on our website



Double wire (loop), floating, connection 9/10 grounded directly, e.g., for DSL applications



Double wire (loop), floating, connection 9/10 grounded directly, e.g., for DSL applications

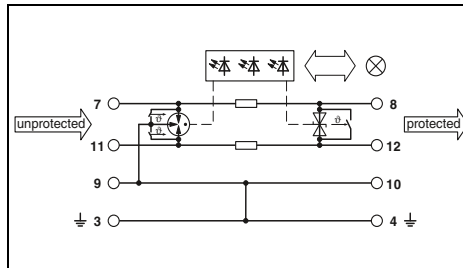

#### Technical data

Electrical data	... 24DC
IEC test classification/EN type	C1 / C2 / C3 / D1 / B2
Maximum continuous operating voltage $U_C$	180 V DC
Impulse discharge curr. $I_{imp}$ (10/350) $\mu$ s	2.5 kA
Nominal current $I_N$	150 mA (25°C)
Nominal discharge current $I_n$ (8/20) $\mu$ s	10 kA / 10 kA
Total surge current (8/20) $\mu$ s	
Protection level $U_p$	Core-Core $\leq 290$ V (C3 - 50 A) Core-Ground $\leq 700$ V (C3 - 50 A)
Cut-off frequency $f_g$ (3 dB)	typ. 25 MHz
Resistance per path	1.2 $\Omega$
General data	
Dimensions W / H / D	17.7 mm / 91.1 mm / 77.5 mm
Connection data solid / stranded / AWG	0.2 ... 4 mm <sup>2</sup> / 0.2 ... 2.5 mm <sup>2</sup> / 24 - 12
Temperature range	-40°C ... 70°C
Degree of protection in acc. with IEC 60529/EN 60529	IP20
Inflammability class in acc. with UL 94	V-0
Test standards	IEC 61643-21 / EN 61643-21 / EN 61000-6-2 / EN 61000-6-3
Remote indication contact	Via TBUS

#### Ordering data

Description	Voltage $U_N$
DATA-PLUGTRAB, with screw connection technology	180 V DC
DATA-PLUGTRAB, with push-in connection technology	180 V DC

Type	Order No.	Pcs. / Pkt.
PT-IQ-1X2-TELE-UT	2800769	1

#### Accessories

Replacement plug
PLUGTRAB supply module with screw connection technology
PLUGTRAB supply module with push-in connection technology

Type	Order No.	Pcs. / Pkt.
PT-IQ-1X2-TELE-P	2800782	1
PT-IQ-PTB-UT	2800768	1

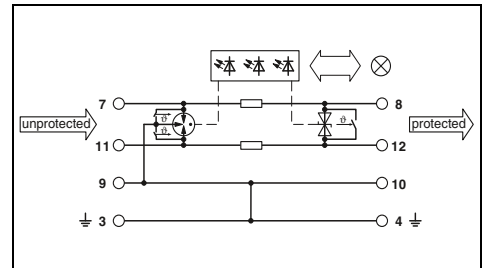

#### Technical data

Electrical data	... 24DC
IEC test classification/EN type	C1 / C2 / C3 / D1 / B2
Maximum continuous operating voltage $U_C$	180 V DC
Impulse discharge curr. $I_{imp}$ (10/350) $\mu$ s	2.5 kA
Nominal current $I_N$	150 mA (25°C)
Nominal discharge current $I_n$ (8/20) $\mu$ s	10 kA / 10 kA
Total surge current (8/20) $\mu$ s	
Protection level $U_p$	Core-Core $\leq 290$ V (C3 - 50 A) Core-Ground $\leq 700$ V (C3 - 50 A)
Cut-off frequency $f_g$ (3 dB)	typ. 25 MHz
Resistance per path	1.2 $\Omega$
General data	
Dimensions W / H / D	17.7 mm / 109.3 mm / 77.5 mm
Connection data solid / stranded / AWG	0.2 ... 4 mm <sup>2</sup> / 0.2 ... 2.5 mm <sup>2</sup> / 24 - 12
Temperature range	-40°C ... 70°C
Degree of protection in acc. with IEC 60529/EN 60529	IP20
Inflammability class in acc. with UL 94	V-0
Test standards	IEC 61643-21 / EN 61643-21 / EN 61000-6-2 / EN 61000-6-3
Remote indication contact	Via TBUS

#### Ordering data

Type	Order No.	Pcs. / Pkt.
PT-IQ-1X2-TELE-PT	2801290	1

#### Accessories

Type	Order No.	Pcs. / Pkt.
PT-IQ-1X2-TELE-P	2800782	1
PT-IQ-PTB-PT	2801296	1



### PLUGTRAB PT-IQ EX with screw connection

- Tailored to the special requirements of intrinsically safe circuits
- Multi-stage status monitoring
- Group indication via supply and remote signaling module
- Multi-stage, floating remote signaling
- System supplied via DIN rail bus
- Up to 10 protection modules per supply module
- Maximum ease of maintenance, thanks to the two-piece design
- Plugs are coded
- Impedance-neutral disconnection of plug for maintenance purposes
- Base element remains an integral part of the installation
- Corresponding replacement plugs can be found on our website



**Double wire (loop), floating, connection 9/10 grounded directly, e.g., for 4 ... 20 mA current loop**

Ex:

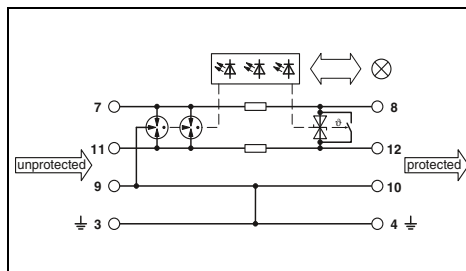

#### Technical data

Electrical data	... 24DC
IEC test classification/EN type	C1 / C2 / C3 / D1
Maximum continuous operating voltage $U_C$	30 V DC / 21 V AC
Impulse discharge curr. $I_{imp}$ (10/350) $\mu$ s	2 kA
Nominal current $I_N$	350 mA
Nominal discharge current $I_n$ (8/20) $\mu$ s	
	Core-Core / Core-Ground
Total surge current (8/20) $\mu$ s	10 kA / 10 kA
Protection level $U_p$	20 kA
	Core-Core
	Core-Ground
	$\leq 50$ V (C3 - 25 A)
	$\leq 1.3$ kV (C3 - 100 A)
Cut-off frequency $f_g$ (3 dB)	
	Symmetrical in the 150 $\Omega$ system
Resistance per path	typ. 1.1 MHz
General data	1.2 $\Omega$
Dimensions W / H / D	17.7 mm / 91.1 mm / 77.5 mm
Connection data solid / stranded with ferrule / AWG	0.2 ... 4 mm <sup>2</sup> / 0.2 ... 2.5 mm <sup>2</sup> / 24 - 12
Temperature range	-40°C ... 70°C
Degree of protection in acc. with IEC 60529/EN 60529	IP20
Inflammability class in acc. with UL 94	V0
Test standards	EN 61643-21/A2 / IEC 61643-21/A2 / EN 61000-6-2 / EN 61000-6-3/A1
Remote indication contact	Via TBUS

#### Ordering data

Description	Voltage $U_N$
MCR-PLUGTRAB, with screw connection technology	24 V DC

Type	Order No.	Pcs. / Pkt.
PT-IQ-1X2-EX-24DC-UT	2801512	1

#### Accessories

Replacement plug	24 V DC
PLUGTRAB supply module	with screw connection technology

Type	Order No.	Pcs. / Pkt.
PT-IQ-1X2-EX-24DC-P	2801514	1
PT-IQ-PTB-UT	2800768	1



**2 double wires (loops), floating, connection 9/10 grounded directly, e.g., for 4 ... 20 mA current loop**

Ex:

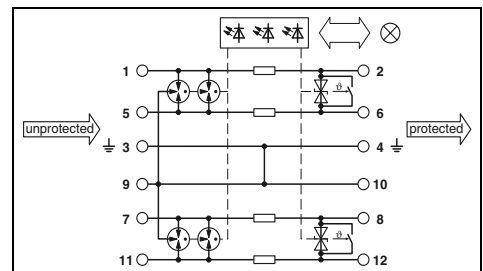

#### Technical data

Electrical data	... 24DC
IEC test classification/EN type	C1 / C2 / C3 / D1
Maximum continuous operating voltage $U_C$	30 V DC / 21 V AC
Impulse discharge curr. $I_{imp}$ (10/350) $\mu$ s	2 kA
Nominal current $I_N$	350 mA
Nominal discharge current $I_n$ (8/20) $\mu$ s	
	Core-Core / Core-Ground
Total surge current (8/20) $\mu$ s	10 kA / 10 kA
Protection level $U_p$	20 kA
	Core-Core
	Core-Ground
	$\leq 50$ V (C3 - 25 A)
	$\leq 1.3$ kV (C3 - 100 A)
Cut-off frequency $f_g$ (3 dB)	
	Symmetrical in the 150 $\Omega$ system
Resistance per path	typ. 1.1 MHz
General data	1.2 $\Omega$
Dimensions W / H / D	17.7 mm / 91.1 mm / 77.5 mm
Connection data solid / stranded with ferrule / AWG	0.2 ... 4 mm <sup>2</sup> / 0.2 ... 2.5 mm <sup>2</sup> / 24 - 12
Temperature range	-40°C ... 70°C
Degree of protection in acc. with IEC 60529/EN 60529	IP20
Inflammability class in acc. with UL 94	V0
Test standards	EN 61643-21/A2 / IEC 61643-21/A2 / EN 61000-6-2 / EN 61000-6-3/A1
Remote indication contact	Via TBUS

#### Ordering data

Type	Order No.	Pcs. / Pkt.
PT-IQ-2X2-EX-24DC-UT	2801513	1

#### Accessories

Type	Order No.	Pcs. / Pkt.
PT-IQ-2X2-EX-24DC-P	2801515	1
PT-IQ-PTB-UT	2800768	1

# Surge protection and interference suppression filters

## Surge protection for MCR technology

### MCR-PLUGTRAB PT, two double wires or 4-wire

- Consistent plug-in signal circuit protection
- Maximum ease of maintenance thanks to the two-piece design
- Base element remains an integral part of the installation
- Impedance-neutral disconnection of plug for test and maintenance purposes
- Plugs can be checked with CHECKMASTER

#### PT 2x2...

- Protection for two separate floating signal circuits
- Installed in conjunction with the PT 2x2...-BE base element

#### PT 4x1...

- Protection for four wires with common reference potential
- Installed in conjunction with the PT 4x1...-BE base element

#### \* Note:

Various grounding options for the base elements:

**PT .x.-BE** connection 9/10 (GND) directly connected to the mounting foot.

**PT .x.+F-BE** connection 9/10 (GND) connected to the mounting foot via a gas-filled surge arrester.



2 double wires (loops), floating, e.g., for 4 ... 20 mA current loops

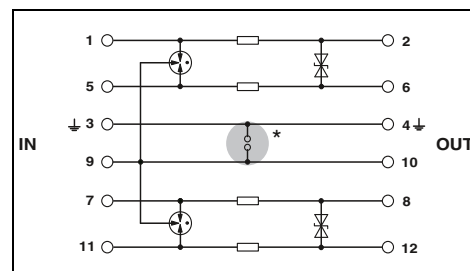

Electrical data	Technical data		
	... 5DC	... 12DC	... 24DC
IEC test classification/EN type	C1 / C2 / C3 / D1	C1 / C2 / C3 / D1	C1 / C2 / C3 / D1
Maximum continuous operating voltage $U_c$	6 V DC / 4 V AC	13 V DC / 9 V AC	28 V DC / 20 V AC
Impulse discharge curr. $I_{imp}$ (10/350) $\mu$ s	2.5 kA	2.5 kA	2.5 kA
Nominal current $I_N$	450 mA (45°C)	450 mA (45°C)	450 mA (45°C)
Nominal discharge current $I_n$ (8/20) $\mu$ s	10 kA / 10 kA	10 kA / 10 kA	10 kA / 10 kA
Total surge current (8/20) $\mu$ s	20 kA	20 kA	20 kA
Output voltage limitation at 1 kV/ $\mu$ s	Core-Core Core-Ground	$\leq 10$ V -	$\leq 18$ V -
Core-Core	$\leq 10$ V	$\leq 18$ V	$\leq 40$ V
Core-Ground	-	-	-
Cut-off frequency $f_g$ (3 dB)	typ. 1 MHz / -	typ. 3 MHz / -	typ. 4.5 MHz / -
Symmetrical / asymmetrical in the 50 $\Omega$ system	2.2 $\Omega$	2.2 $\Omega$	-
Resistance per path			
General data			
Dimensions W / H / D		17.7 mm / 90 mm / 65.5 mm	
Connection data solid / stranded / AWG		0.2 ... 4 mm <sup>2</sup> / 0.2 ... 2.5 mm <sup>2</sup> / 24 - 12	
Temperature range		-40°C ... 85°C	
Degree of protection in acc. with IEC 60529/EN 60529		IP20	
Inflammability class in acc. with UL 94		V0	
Test standards		IEC 61643-21	

Ordering data	
Type	Order No.
PT 2X2-5DC-ST	2838241
PT 2X2-12DC-ST	2838254
PT 2X2-24DC-ST	2838228
PT 2X2-BE	2839208
PT 2X2+F-BE	2839224

Accessories	
Type	Order No.
SSA 3-6	2839295
SSA 5-10	2839512



2 double wires (loops), floating, e.g., for 4 ... 20 mA current loops



4-wire, with common reference potential, e.g., for binary signals



4-wire, with common reference potential, e.g., for binary signals

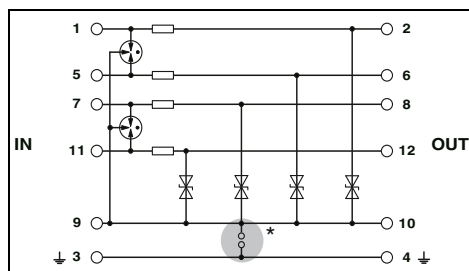
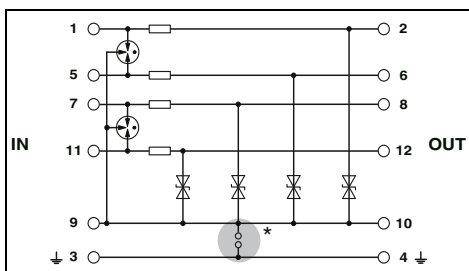
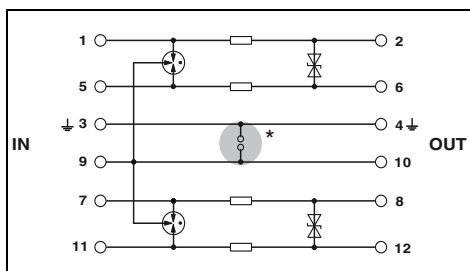

Technical data	
... 12AC	... 24AC
C1 / C2 / C3 / D1	C1 / C2 / C3 / D1
18 V DC / 13 V AC	40 V DC / 28 V AC
2.5 kA	2.5 kA
450 mA (45°C)	450 mA (45°C)
10 kA / 10 kA	10 kA / 10 kA
20 kA	20 kA
≤ 25 V	≤ 55 V
-	-
typ. 4 MHz / - 2.2 Ω	typ. 8 MHz / - 2.2 Ω

Technical data			
... 5DC	... 12DC	... 24DC	... 48DC
C1 / C2 / C3 / D1	C1 / C2 / C3 / D1	C1 / C2 / C3 / D1	C1 / C2 / C3 / D1
6 V DC / 4 V AC	13 V DC / 9 V AC	28 V DC / 20 V AC	53 V DC / 37 V AC
2.5 kA	2.5 kA	2.5 kA	2.5 kA
300 mA (45°C)	300 mA (45°C)	300 mA (45°C)	300 mA (45°C)
- / 10 kA	- / 10 kA	- / 10 kA	- / 10 kA
20 kA	20 kA	20 kA	20 kA
-	-	-	-
≤ 10 V	≤ 18 V	≤ 40 V	≤ 70 V
- / typ. 1 MHz	- / typ. 3 MHz	- / typ. 6 MHz	- / typ. 9 MHz
4.7 Ω	4.7 Ω	4.7 Ω	4.7 Ω

Technical data		
... 12AC	... 24AC	... 48AC
C1 / C2 / C3 / D1	C1 / C2 / C3 / D1	C1 / C2 / C3 / D1
18 V DC / 13 V AC	40 V DC / 28 V AC	77 V DC / 55 V AC
2.5 kA	2.5 kA	2.5 kA
300 mA (45°C)	300 mA (45°C)	300 mA (45°C)
- / 10 kA	- / 10 kA	- / 10 kA
20 kA	20 kA	20 kA
-	-	-
≤ 25 V	≤ 55 V	≤ 110 V (BE: 4x1)
- / typ. 4 MHz	- / typ. 8 MHz	- / typ. 10 MHz
4.7 Ω	4.7 Ω	4.7 Ω

17.7 mm / 90 mm / 65.5 mm  
0.2 ... 4 mm<sup>2</sup> / 0.2 ... 2.5 mm<sup>2</sup> / 24 - 12  
-40°C ... 85°C  
IP20  
V0  
IEC 61643-21

17.7 mm / 90 mm / 65.5 mm  
0.2 ... 4 mm<sup>2</sup> / 0.2 ... 2.5 mm<sup>2</sup> / 24 - 12  
-40°C ... 85°C  
IP20  
V0  
IEC 61643-21

17.7 mm / 90 mm / 65.5 mm  
0.2 ... 4 mm<sup>2</sup> / 0.2 ... 2.5 mm<sup>2</sup> / 24 - 12  
-40°C ... 85°C  
IP20  
V0  
IEC 61643-21

Ordering data		
Type	Order No.	Pcs. / Pkt.
PT 2X2-12AC-ST	2838270	10
PT 2X2-24AC-ST	2838283	10
PT 2X2-BE	2839208	10
PT 2X2+F-BE	2839224	10

Ordering data		
Type	Order No.	Pcs. / Pkt.
PT 4X1-5DC-ST	2838306	10
PT 4X1-12DC-ST	2838319	10
PT 4X1-24DC-ST	2838322	10
PT 4X1-48DC-ST	2858014	10
PT 4X1-BE	2839363	10
PT 4X1+F-BE	2839376	10

Ordering data		
Type	Order No.	Pcs. / Pkt.
PT 4X1-12AC-ST	2838348	10
PT 4X1-24AC-ST	2838351	10
PT 4X1-48AC-ST	2804856	10
PT 4X1-BE	2839363	10
PT 4X1+F-BE	2839376	10

Accessories		
SSA 3-6	2839295	10
SSA 5-10	2839512	10

Accessories		
SSA 3-6	2839295	10
SSA 5-10	2839512	10

Accessories		
SSA 3-6	2839295	10
SSA 5-10	2839512	10

# Surge protection and interference suppression filters

## Surge protection for MCR technology

### MCR-PLUGTRAB PT, one double wire or 2-wire

- Consistent plug-in signal circuit protection
- Maximum ease of maintenance thanks to the two-piece design
- Base element remains an integral part of the installation
- Impedance-neutral disconnection of plug for test and maintenance purposes
- Plugs can be checked with CHECKMASTER

#### PT 1x2...

- Protection for a floating signal circuit
- Installed in conjunction with the PT 1x2...-BE base element

#### PT 2x1...

- Protection for two wires with common reference potential
- Installed in conjunction with the PT 2x1...-BE base element

#### \* Note:

Various grounding options for the base elements:

**PT .x.-BE** connection 9/10 (GND) directly connected to the mounting foot.

**PT .x.+F-BE** connection 9/10 (GND) connected to the mounting foot via a gas-filled surge arrester.



Double wire (loop), floating, e.g., for 4 ... 20 mA current loops

ERC

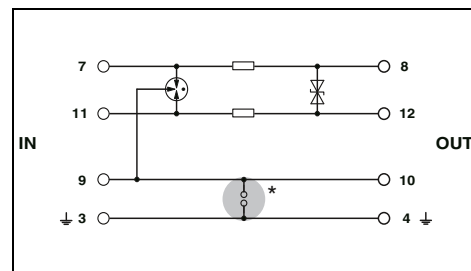

#### Technical data

Electrical data	... 5DC	... 12DC	... 24DC	... 48DC
IEC test classification/EN type	C1 / C2 / C3 / D1	C1 / C2 / C3 / D1	C1 / C2 / C3 / D1	C1 / C2 / C3 / D1
Maximum continuous operating voltage $U_c$	6 V DC / 4 V AC	13 V DC / 9 V AC	28 V DC / 20 V AC	53 V DC / 37 V AC
Impulse discharge curr. $I_{imp}$ (10/350) $\mu$ s	2.5 kA	2.5 kA	2.5 kA	2.5 kA
Nominal current $I_N$	450 mA (45°C)	450 mA (45°C)	450 mA (45°C)	450 mA (45°C)
Nominal discharge current $I_n$ (8/20) $\mu$ s				
	Core-Core / Core-Ground	Core-Core / Core-Ground	Core-Core / Core-Ground	Core-Core / Core-Ground
Total surge current (8/20) $\mu$ s	10 kA / 10 kA	10 kA / 10 kA	10 kA / 10 kA	10 kA / 10 kA
Output voltage limitation at 1 kV/ $\mu$ s	20 kA	20 kA	20 kA	20 kA
	Core-Core	Core-Core	Core-Core	Core-Core
	Core-Ground	Core-Ground	Core-Ground	Core-Ground
	$\leq 10$ V	$\leq 18$ V	$\leq 40$ V	$\leq 70$ V
	-	-	-	-
Cut-off frequency $f_g$ (3 dB)				
	Symmetrical / asymmetrical in the 50 $\Omega$ system	Symmetrical / asymmetrical in the 50 $\Omega$ system	Symmetrical / asymmetrical in the 50 $\Omega$ system	Symmetrical / asymmetrical in the 50 $\Omega$ system
	typ. 1 MHz / -	typ. 3 MHz / -	typ. 4.5 MHz / -	typ. 10 MHz / -
Resistance per path	2.2 $\Omega$	2.2 $\Omega$	2.2 $\Omega$	2.2 $\Omega$
General data				
Dimensions W / H / D			17.7 mm / 90 mm / 65.5 mm	
Connection data solid / stranded / AWG			0.2 ... 4 mm <sup>2</sup> / 0.2 ... 2.5 mm <sup>2</sup> / 24 - 12	
Temperature range			-40°C ... 85°C	
Degree of protection in acc. with IEC 60529/EN 60529			IP20	
Inflammability class in acc. with UL 94			V0	
Test standards			IEC 61643-21	

#### Ordering data

Description	Voltage $U_N$	Type	Order No.	Pcs. / Pkt.
<b>PLUGTRAB plug</b> , with protective circuit for plugging into PT base element				
	5 V DC	PT 1X2- 5DC-ST	2856016	10
	12 V DC	PT 1X2-12DC-ST	2856029	10
	24 V DC	PT 1X2-24DC-ST	2856032	10
	12 V AC			
	24 V AC			
	48 V DC	PT 1X2-48DC-ST	2803658	10
<b>PLUGTRAB base element</b> , for mounting on NS 35				
Bridge between 3/4 ( $\frac{1}{2}$ ) and 9/10		PT 1X2-BE	2856113	10
Gas-filled surge arrester between 3/4 ( $\frac{1}{2}$ ) and 9/10		PT 1X2+F-BE	2856126	10

#### Accessories

Shield fast connection	Order No.	Pcs. / Pkt.
For $\varnothing$ 3-6 mm	2839295	10
For $\varnothing$ 5-10 mm	2839512	10



Double wire (loop), floating, e.g., for 4 ... 20 mA current loops

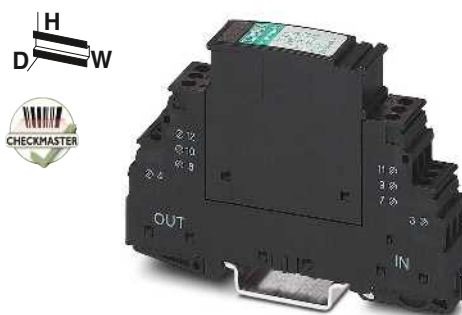

2-wire, with common reference potential, e.g., for binary signals



2-wire, with common reference potential, e.g., for binary signals

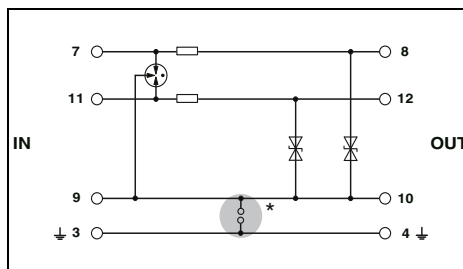
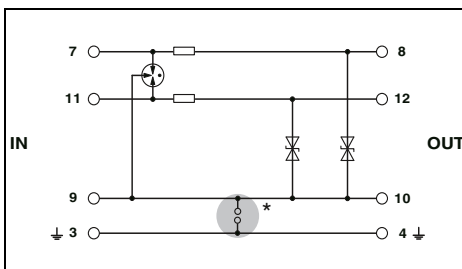
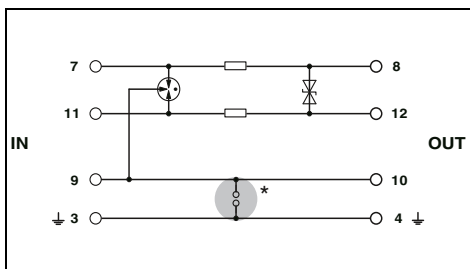

### Technical data

... 12AC	... 24AC
C1 / C2 / C3 / D1	C1 / C2 / C3 / D1
18 V DC / 13 V AC	40 V DC / 28 V AC
2.5 kA	2.5 kA
450 mA (45°C)	450 mA (45°C)
10 kA / 10 kA	10 kA / 10 kA
20 kA	20 kA
≤ 25 V	≤ 55 V
-	-
typ. 4 MHz / - 2.2 Ω	typ. 8 MHz / - 2.2 Ω

17.7 mm / 90 mm / 65.5 mm  
 0.2 ... 4 mm<sup>2</sup> / 0.2 ... 2.5 mm<sup>2</sup> / 24 - 12  
 -40°C ... 85°C  
 IP20  
 V0  
 IEC 61643-21

### Technical data

... 5DC	... 12DC	... 24DC
C1 / C2 / C3 / D1	C1 / C2 / C3 / D1	C1 / C2 / C3 / D1
6 V DC / 4 V AC	13 V DC / 9 V AC	28 V DC / 20 V AC
2.5 kA	2.5 kA	2.5 kA
300 mA (45°C)	300 mA (45°C)	300 mA (45°C)
- / 10 kA	- / 10 kA	- / 10 kA
20 kA	20 kA	20 kA
≤ 10 V	≤ 18 V	≤ 40 V
-	-	-
- / typ. 1 MHz	- / typ. 3 MHz	- / typ. 4.5 MHz
4.7 Ω	4.7 Ω	4.7 Ω

17.7 mm / 90 mm / 65.5 mm  
 0.2 ... 4 mm<sup>2</sup> / 0.2 ... 2.5 mm<sup>2</sup> / 24 - 12  
 -40°C ... 85°C  
 IP20  
 V0  
 IEC 61643-21

### Technical data

... 12AC	... 24AC
C1 / C2 / C3 / D1	C1 / C2 / C3 / D1
18 V DC / 13 V AC	40 V DC / 28 V AC
2.5 kA	2.5 kA
300 mA (45°C)	300 mA (45°C)
- / 10 kA	- / 10 kA
20 kA	20 kA
≤ 25 V	≤ 55 V
-	-
- / typ. 4 MHz	- / typ. 8 MHz
4.7 Ω	4.7 Ω

17.7 mm / 90 mm / 65.5 mm  
 0.2 ... 4 mm<sup>2</sup> / 0.2 ... 2.5 mm<sup>2</sup> / 24 - 12  
 -40°C ... 85°C  
 IP20  
 V0  
 IEC 61643-21

### Ordering data

Type	Order No.	Pcs. / Pkt.
PT 1X2-12AC-ST	2856045	10
PT 1X2-24AC-ST	2856058	10
PT 1X2-BE	2856113	10
PT 1X2+F-BE	2856126	10

### Ordering data

Type	Order No.	Pcs. / Pkt.
PT 2X1-5DC-ST	2856061	10
PT 2X1-12DC-ST	2856074	10
PT 2X1-24DC-ST	2856087	10
PT 2X1-BE	2856139	10
PT 2X1+F-BE	2856142	10

### Ordering data

Type	Order No.	Pcs. / Pkt.
PT 2X1-12AC-ST	2856090	10
PT 2X1-24AC-ST	2856100	10
PT 2X1-BE	2856139	10
PT 2X1+F-BE	2856142	10

### Accessories

SSA 3-6	2839295	10
SSA 5-10	2839512	10

### Accessories

SSA 3-6	2839295	10
SSA 5-10	2839512	10

### Accessories

SSA 3-6	2839295	10
SSA 5-10	2839512	10

# Surge protection and interference suppression filters

## Surge protection for MCR technology

### MCR-PLUGTRAB PT, 4-wire or combination with power supply

- Consistent plug-in signal circuit protection
- Maximum ease of maintenance thanks to the two-piece design
- Base element remains an integral part of the installation
- Impedance-neutral disconnection of plug for test and maintenance purposes
- Plugs can be checked with CHECKMASTER

**\* Note:**

Various grounding options for the base elements:

**PT .x.-BE** connection 9/10 (GND) directly connected to the mounting foot.

**PT .x.+F-BE** connection 9/10 (GND) connected to the mounting foot via a gas-filled surge arrester.



4-wire, floating, impedance-free, e.g., for temperature measurement



Combination of double wire protection (floating) and single-phase power supply

ERC

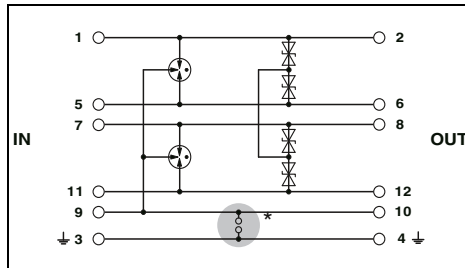

ERC

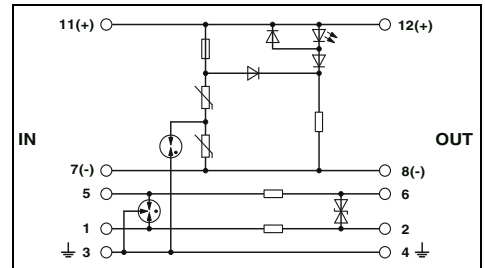

#### Technical data

Electrical data	... 5DC	... 12DC	... 24DC	... 24AC
	IEC test classification/EN type	C1 / C2 / C3 / D1	C1 / C2 / C3 / D1	C1 / C2 / C3 / D1
Maximum continuous operating voltage $U_c$	6 V DC / 4 V AC	12.8 V DC / 9 V AC	27 V DC / 19 V AC	40 V DC / 28 V AC
Impulse discharge curr. $I_{imp}$ (10/350) $\mu$ s	2.5 kA	2.5 kA	2.5 kA	2.5 kA
Nominal current $I_N$	2 A (80°C)	2 A (80°C)	2 A (80°C)	2 A AC (80°C)
Nominal discharge current $I_n$ (8/20) $\mu$ s				
Total surge current (8/20) $\mu$ s	720 A / 10 kA	690 A / 10 kA	365 A / 10 kA	187 A / 10 kA
	20 kA	20 kA	20 kA	20 kA
Max. discharge current $I_{max}$ (8/20) $\mu$ s	10 kA	10 kA	10 kA	10 kA
Output voltage limitation at 1 kV/ $\mu$ s				
Core-Core	$\leq 10$ V	$\leq 18$ V	$\leq 40$ V	$\leq 75$ V
Core-Ground	$\leq 450$ V	$\leq 450$ V	$\leq 450$ V (PT 4-BE)	$\leq 450$ V (PT 4-BE)

#### Technical data

Mains protection	Data protection
III / T3	C1 / C2 / C3 / D1
44 V DC / 34 V AC	40 V DC / 28 V AC
-	2.5 kA
6 A (30°C)	450 mA (45°C)
700 A / 700 A	10 kA / 10 kA
-	20 kA
2 kA	10 kA
-	$\leq 55$ V
-	450 V

General data	
Dimensions W / H / D	17.7 mm / 90 mm / 65.5 mm
Connection data solid / stranded / AWG	0.2 ... 4 mm <sup>2</sup> / 0.2 ... 2.5 mm <sup>2</sup> / 24 - 12
Temperature range	-40°C ... 85°C
Degree of protection in acc. with IEC 60529/EN 60529	IP20
Inflammability class in acc. with UL 94	V0
Test standards	IEC 61643-21 / DIN EN 61643-21 / UL 497B

General data	
Dimensions W / H / D	17.7 mm / 90 mm / 65.5 mm
Connection data solid / stranded / AWG	0.2 ... 4 mm <sup>2</sup> / 0.2 ... 2.5 mm <sup>2</sup> / 24 - 12
Temperature range	-40°C ... 85°C
Degree of protection in acc. with IEC 60529/EN 60529	IP20
Inflammability class in acc. with UL 94	V0
Test standards	IEC 61643-1 / EN 61643-11 IEC 61643-21

#### Ordering data

Description	Voltage $U_N$	Type	Order No.	Pcs. / Pkt.
<b>PLUGTRAB plug</b> , with protective circuit for plugging into PT base element	5 V DC	PT 4-5DC-ST	2839211	10
	12 V DC	PT 4-12DC-ST	2839237	10
	24 V DC	PT 4-24DC-ST	2839240	10
	24 V AC	PT 4-24AC-ST	2800078	1
<b>PLUGTRAB base element</b> , for mounting on NS 35	Bridge between 3/4 ( $\downarrow$ ) and 9/10	PT 4-BE	2839402	10
	Gas-filled surge arrester between 3/4 ( $\downarrow$ ) and 9/10	PT 4+F-BE	2839415	10

#### Ordering data

Description	Voltage $U_N$	Type	Order No.	Pcs. / Pkt.
<b>PLUGTRAB base element</b> , for mounting on NS 35	PT PE/S+1X2-24-ST	2819008	10	
	PT PE/S+1X2-BE	2856265	10	

#### Accessories

Shield fast connection	Order No.	Pcs. / Pkt.
For $\varnothing$ 3-6 mm	SSA 3-6 2839295	10
For $\varnothing$ 5-10 mm	SSA 5-10 2839512	10

#### Accessories

Shield fast connection	Order No.	Pcs. / Pkt.
For $\varnothing$ 3-6 mm	SSA 3-6 2839295	10
For $\varnothing$ 5-10 mm	SSA 5-10 2839512	10

### MCR-PLUGTRAB PT, for higher signal voltages

- Protective devices for higher nominal power
- Consistent plug-in signal circuit protection
- Maximum ease of maintenance thanks to the two-piece design
- Base element remains an integral part of the installation
- Impedance-neutral disconnection of plug for test and maintenance purposes
- Plugs can be checked with CHECKMASTER
- FM types with permanent and independent monitoring by a diagnostics unit



2-wire, floating, free of leakage current, e.g., for actuator circuits



2-wire, with common reference potential, remote signaling, e.g., for actuator circuits

**Notes:**  
If no protective plug is inserted, there is no electrical connection.

ERC

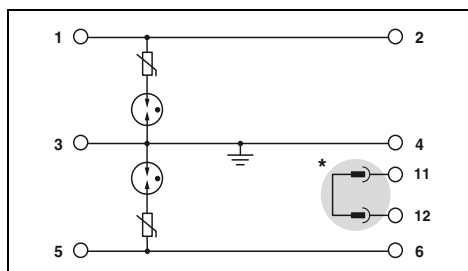

ERC

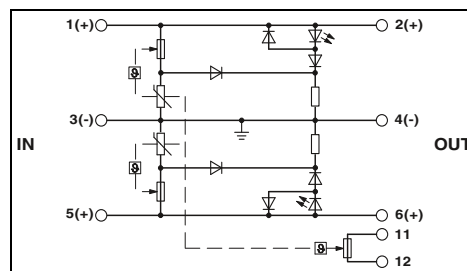

Electrical data		... 120AC	... 230AC
IEC test classification/EN type		C1 / C2 / C3	C1 / C2 / C3 / D1
Maximum continuous operating voltage $U_c$		- / 175 V AC	- / 250 V AC
Impulse discharge curr. $I_{imp}$ (10/350) $\mu$ s		300 A	500 A
Nominal current $I_N$		6 A	6 A
Nominal discharge current $I_n$ (8/20) $\mu$ s		3 kA	3 kA
Total surge current (8/20) $\mu$ s		8 kA	8 kA
Output voltage limitation at 1 kV/ $\mu$ s		$\leq$ 800 V	$\leq$ 1.4 kV
<b>General data</b>			
Dimensions W / H / D		17.7 mm / 90 mm / 65.5 mm	
Connection data solid / stranded / AWG		0.2 ... 4 mm <sup>2</sup> / 0.2 ... 2.5 mm <sup>2</sup> / 24 - 12	
Temperature range		-40°C ... 80°C	
Degree of protection in acc. with IEC 60529/EN 60529		IP20	
Inflammability class in acc. with UL 94		V0	
Test standards		EN 61643-21	

Technical data		
... 60AC	... 120AC	... 230AC
C1 / C2 / C3 / D1	C1 / C2 / C3 / D1	C1 / C2 / C3 / D1
500 A	500 A	500 A
26 A AC (30°C)	26 A AC (30°C)	26 A AC (30°C)
2 kA	2.5 kA	2.5 kA
4 kA	5 kA	5 kA

Technical data		
... 60AC	... 120AC	... 230AC
C1 / C2 / C3 / D1	C1 / C2 / C3 / D1	C1 / C2 / C3 / D1
500 A	500 A	500 A
26 A AC (30°C)	26 A AC (30°C)	26 A AC (30°C)
2 kA	2.5 kA	2.5 kA
4 kA	5 kA	5 kA

General data	
Dimensions W / H / D	17.7 mm / 90 mm / 65.5 mm
Connection data solid / stranded / AWG	0.2 ... 4 mm <sup>2</sup> / 0.2 ... 2.5 mm <sup>2</sup> / 24 - 12
Temperature range	-40°C ... 80°C
Degree of protection in acc. with IEC 60529/EN 60529	IP20
Inflammability class in acc. with UL 94	V0
Test standards	EN 61643-21

Ordering data			
Type	Order No.	Pcs. / Pkt.	
PT 2X1-VF-120AC	2859327	10	
PT 2X1-VF-230AC	2805460	10	
PT 2X1-VF-120AC-ST	2856799	10	
PT 2X1-VF-230AC-ST	2921365	10	
PT-BE/FM	2839282	10	

Ordering data			
Type	Order No.	Pcs. / Pkt.	
PT 2X1VA- 60AC-ST	2839172	10	
PT 2X1VA-120AC-ST	2839185	10	
PT 2X1VA-230AC-ST	2839198	10	
PT-BE/FM	2839282	10	

Accessories	
Shield fast connection For $\varnothing$ 3-6 mm	SSA 3-6
For $\varnothing$ 5-10 mm	SSA 5-10

Accessories			
SSA 3-6	2839295	10	
SSA 5-10	2839512	10	

Accessories			
SSA 3-6	2839295	10	
SSA 5-10	2839512	10	

# Surge protection and interference suppression filters

## Surge protection for MCR technology

### MCR-PLUGTRAB PT coarse surge protection

- For systems with high electric strength or fine protection installed
- Installation location - directly where the MCR cable enters the building
- Consistent plug-in signal circuit protection
- Maximum ease of maintenance thanks to the two-piece design
- Base element remains an integral part of the installation
- Impedance-neutral disconnection of plug for test and maintenance purposes
- Plugs can be checked with CHECKMASTER



2-wire, coarse protection, e.g., for actuator circuits



4-wire, coarse protection, e.g., for actuator circuits

ERC

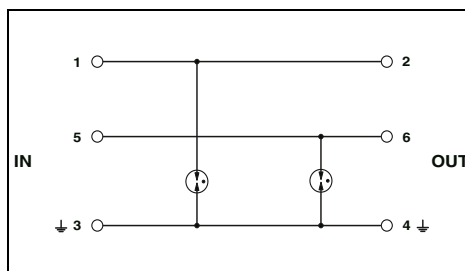

#### Technical data

Electrical data	
IEC test classification/EN type	C1 / C2 / C3 / D1
Maximum continuous operating voltage $U_C$	68 V DC / 48 V AC
Impulse discharge curr. $I_{imp}$ (10/350) $\mu$ s	5 kA
Nominal current $I_N$	2 A (80°C)
Nominal discharge current $I_n$ (8/20) $\mu$ s	- / 20 kA
	40 kA
Total surge current (8/20) $\mu$ s	Core-Core / Core-Ground
Protection level $U_p$	Core-Ground
	$\leq 600$ V
Output voltage limitation at 1 kV/ $\mu$ s	Core-Ground
	$\leq 600$ V
General data	
Dimensions W / H / D	17.7 mm / 90 mm / 65.5 mm
Connection data solid / stranded / AWG	0.2 ... 4 mm <sup>2</sup> / 0.2 ... 2.5 mm <sup>2</sup> / 24 - 12
Temperature range	-40°C ... 85°C
Degree of protection in acc. with IEC 60529/EN 60529	IP20
Inflammability class in acc. with UL 94	V0
Test standards	IEC 61643-21

ERC

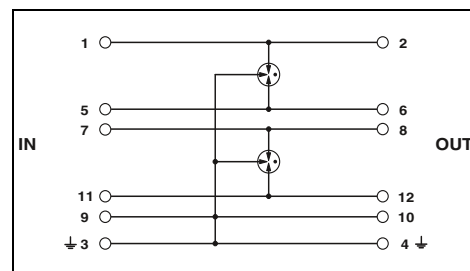

#### Technical data

Electrical data	
IEC test classification/EN type	C1 / C2 / C3 / D1
Maximum continuous operating voltage $U_C$	170 V DC / 120 V AC
Impulse discharge curr. $I_{imp}$ (10/350) $\mu$ s	2.5 kA
Nominal current $I_N$	2 A (80°C)
Nominal discharge current $I_n$ (8/20) $\mu$ s	10 kA / 10 kA
Total surge current (8/20) $\mu$ s	20 kA
Protection level $U_p$	Core-Ground
	$\leq 450$ V
Output voltage limitation at 1 kV/ $\mu$ s	Core-Ground
	$\leq 450$ V
General data	
Dimensions W / H / D	17.7 mm / 90 mm / 65.5 mm
Connection data solid / stranded / AWG	0.2 ... 4 mm <sup>2</sup> / 0.2 ... 2.5 mm <sup>2</sup> / 24 - 12
Temperature range	-40°C ... 85°C
Degree of protection in acc. with IEC 60529/EN 60529	IP20
Inflammability class in acc. with UL 94	V0
Test standards	IEC 61643-21

#### Ordering data

Description	Voltage $U_N$
<b>PLUGTRAB plug</b> , with protective circuit for plugging into PT base element	48 V AC
	110 V AC
<b>PLUGTRAB base element</b> , for mounting on NS 35	
Bridge between 3/4 ( $\frac{1}{2}$ ) and 9/10	

Type	Order No.	Pcs. / Pkt.
PT 2-F-ST	2859000	10
PT-BE/FM	2839282	10

#### Ordering data

Type	Order No.	Pcs. / Pkt.
PT 4-F-ST	2858441	10
PT 4-BE	2839402	10

#### Accessories

<b>Shield fast connection</b>
For $\varnothing$ 3-6 mm
For $\varnothing$ 5-10 mm

SSA 3-6	Order No.	Pcs. / Pkt.
SSA 3-6	2839295	10
SSA 5-10	2839512	10

#### Accessories

SSA 3-6	Order No.	Pcs. / Pkt.
SSA 3-6	2839295	10
SSA 5-10	2839512	10



### MCR-PLUGTRAB PT

#### for Ex-i circuits

- Tailored to the special requirements of intrinsically safe circuits
- Consistent plug-in signal circuit protection
- Maximum ease of maintenance thanks to the two-piece design
- Base element remains an integral part of the installation
- Impedance-neutral disconnection of plug for test and maintenance purposes
- Plugs can be checked with CHECKMASTER



2 double wires (loops), intrinsically safe, e.g., for 4 ... 20 mA current loops

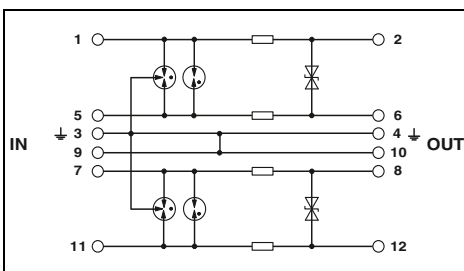

#### Technical data

Electrical data	
IEC test classification/EN type	C1 / C2 / C3 / D1
Maximum continuous operating voltage $U_C$	30 V DC / 21 V AC
Impulse discharge curr. $I_{imp}$ (10/350) $\mu$ s	1 kA
Nominal current $I_N$	325 mA (40°C)
Nominal discharge current $I_n$ (8/20) $\mu$ s	
Total surge current (8/20) $\mu$ s	Core-Core / Core-Ground: 10 kA / 10 kA
Protection level $U_p$	Core-Core: $\leq 50$ V (C3 - 25 A)
	Core-Ground: $\leq 1$ kV (C2 - 10 kV / 5 kA)
Output voltage limitation at 1 kV/ $\mu$ s	Core-Core / Core-Ground: $\leq 45$ V / $\leq 1$ kV
Cut-off frequency $f_g$ (3 dB)	Symmetrical in the 50 $\Omega$ system: typ. 4.5 MHz
Resistance per path	2.2 $\Omega$
General data	
Dimensions W / H / D	17.7 mm / 90 mm / 65.5 mm
Connection data solid / stranded / AWG	0.2 ... 4 mm <sup>2</sup> / 0.2 ... 2.5 mm <sup>2</sup> / 24 - 12
Temperature range	-40°C ... 85°C
Degree of protection in acc. with IEC 60529/EN 60529	IP20
Inflammability class in acc. with UL 94	V-0
Test standards	EN 61643-21/A2 / EN 60079-0 / EN 60079-11 / EN 60079-26 / IEC 60079-0 / IEC 60079-11

Safety data	
EC-type examination certificate according to ATEX	KEMA 00ATEX1099 X
Identification according to ATEX	Ex II 1G Ex ia IIC T4...T6 Ga Ex II 1D Ex ia IIC T135°C...T85°C Da
Maximum inner capacitance $C_i$	1.3 nF
Maximum inner inductance $L_i$	1 $\mu$ H
Maximum input current $I_i$	325 mA ( $T_4 / \leq 80^\circ\text{C}$ )
Maximum input voltage $U_i$	30 V DC
Maximum input power $P_i$	3 W

Description	Voltage $U_N$
PLUGTRAB plug, with protective circuit for plugging into PT base element	24 V DC
PLUGTRAB base element, for mounting on NS 35	

Shield fast connection	
For $\varnothing$ 3-6 mm	SSA 3-6
For $\varnothing$ 5-10 mm	SSA 5-10

Ordering data			
Type	Order No.	Pcs. / Pkt.	
PT 2XEX(I)-24DC-ST	2838225	10	
PT 2XEX(I)-BE	2839279	10	

Accessories			
SSA 3-6	2839295	10	
SSA 5-10	2839512	10	



4-wire, intrinsically safe, impedance-free, e.g., for temperature measurements

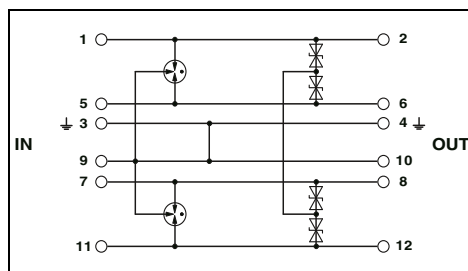

#### Technical data

Electrical data	
IEC test classification/EN type	C1 / C2 / C3 / D1
Maximum continuous operating voltage $U_C$	30 V DC / 21 V AC
Impulse discharge curr. $I_{imp}$ (10/350) $\mu$ s	1 kA
Nominal current $I_N$	308 A (40°C)
Nominal discharge current $I_n$ (8/20) $\mu$ s	
Total surge current (8/20) $\mu$ s	308 A / 10 kA
Protection level $U_p$	Core-Core: $\leq 50$ V (C3 - 25 A)
	Core-Ground: $\leq 1$ kV (C2 - 10 kV / 5 kA)
Output voltage limitation at 1 kV/ $\mu$ s	Core-Core / Core-Ground: $\leq 45$ V / $\leq 1$ kV
Cut-off frequency $f_g$ (3 dB)	Symmetrical in the 50 $\Omega$ system: typ. 7 MHz
Resistance per path	-
General data	
Dimensions W / H / D	17.7 mm / 90 mm / 65.5 mm
Connection data solid / stranded / AWG	0.2 ... 4 mm <sup>2</sup> / 0.2 ... 2.5 mm <sup>2</sup> / 24 - 12
Temperature range	-40°C ... 85°C
Degree of protection in acc. with IEC 60529/EN 60529	IP20
Inflammability class in acc. with UL 94	V-0
Test standards	EN 61643-21/A2 / EN 60079-0 / EN 60079-11 / EN 60079-26 / IEC 60079-0 / IEC 60079-11

Safety data	
EC-type examination certificate according to ATEX	KEMA 00ATEX1099 X
Identification according to ATEX	Ex II 1G Ex ia IIC T4...T6 Ga Ex II 1D Ex ia IIC T135°C...T85°C Da
Maximum inner capacitance $C_i$	1.1 nF
Maximum inner inductance $L_i$	1 $\mu$ H
Maximum input current $I_i$	500 mA ( $T_4 / \leq 80^\circ\text{C}$ )
Maximum input voltage $U_i$	30 V DC
Maximum input power $P_i$	850 mW ( $T_4 / \leq 80^\circ\text{C}$ )

Ordering data			
Type	Order No.	Pcs. / Pkt.	
PT 4-EX(I)-24DC-ST	2839253	10	
PT 4-EX(I)-BE	2839486	10	

Accessories			
SSA 3-6	2839295	10	
SSA 5-10	2839512	10	

# Surge protection and interference suppression filters

## Surge protection for MCR technology

### MCR-PLUGTRAB PT, for various applications

- Protection for fieldbus systems, PROFIBUS (up to 12 Mbps), and signal circuits with three to five-wire technology
- Cable shield connection using SSA... shield fast connection
- Maximum ease of maintenance thanks to the two-piece design
- Base element remains an integral part of the installation
- Impedance-neutral disconnection of plug for test and maintenance purposes

#### \* Note:

Various grounding options for the base elements:

**PT .x.-BE** connection 9/10 (GND) directly connected to the mounting foot.

**PT .x.+F-BE** connection 9/10 (GND) connected to the mounting foot via a gas-filled surge arrester.

**Notes:**  
Attenuation characteristics at phoenixcontact.net/products



5-wire protection for fieldbus and serial interface



3-wire protection for PROFIBUS and serial interface

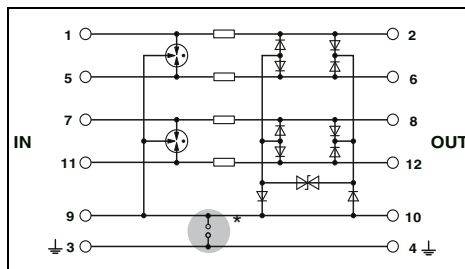

ERC

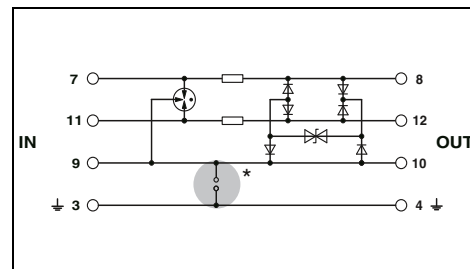

#### Technical data

Electrical data	... 5DC	... 12DC	... 24DC
IEC test classification/EN type	C1 / C2 / C3 / D1	C1 / C2 / C3 / D1	C1 / C2 / C3 / D1
Maximum continuous operating voltage $U_c$	5.2 V DC / 3.6 V AC	14 V DC / 9.8 V AC	-
Impulse discharge curr. $I_{imp}$ (10/350) $\mu$ s	2.5 kA	2.5 kA	2.5 kA
Nominal current $I_N$	450 mA (45°C)	450 mA (45°C)	450 mA (45°C)
Nominal discharge current $I_n$ (8/20) $\mu$ s	Core-Core / Core-Ground		
	10 kA / 10 kA	10 kA / 10 kA	10 kA / 10 kA (with PT 2x2+F-BE)
Total surge current (8/20) $\mu$ s	20 kA	20 kA	20 kA
Output voltage limitation at 1 kV/ $\mu$ s	Core-Core		
	$\leq 15$ V	$\leq 25$ V	-
	Core-Ground		
	$\leq 15$ V	$\leq 25$ V	-
Cut-off frequency $f_g$ (3 dB)	Symmetrical in the 100 $\Omega$ system		
	typ. 60 MHz	typ. 60 MHz	typ. 70 MHz
Resistance per path	2.2 $\Omega$	2.2 $\Omega$	2.2 $\Omega$

#### Technical data

Electrical data	... 5DC	... 12DC
IEC test classification/EN type	C1 / C2 / C3 / D1	C1 / C2 / C3 / D1
Maximum continuous operating voltage $U_c$	5.2 V DC / 3.6 V AC	14 V DC / 9.8 V AC
Impulse discharge curr. $I_{imp}$ (10/350) $\mu$ s	2.5 kA	2.5 kA
Nominal current $I_N$	450 mA (45°C)	450 mA (45°C)
Nominal discharge current $I_n$ (8/20) $\mu$ s	Core-Core / Core-Ground	
	10 kA / 10 kA	10 kA / 10 kA
Total surge current (8/20) $\mu$ s	20 kA	20 kA
Output voltage limitation at 1 kV/ $\mu$ s	Core-Core	
	$\leq 15$ V	$\leq 25$ V
	Core-Ground	
	$\leq 15$ V	$\leq 25$ V
Cut-off frequency $f_g$ (3 dB)	Symmetrical in the 100 $\Omega$ system	
	typ. 60 MHz	typ. 60 MHz
Resistance per path	2.2 $\Omega$	2.2 $\Omega$

General data	
Dimensions W / H / D	17.7 mm / 90 mm / 65.5 mm
Connection data solid / stranded / AWG	0.2 ... 4 mm <sup>2</sup> / 0.2 ... 2.5 mm <sup>2</sup> / 24 - 12
Temperature range	-40°C ... 85°C
Degree of protection in acc. with IEC 60529/EN 60529	IP20
Inflammability class in acc. with UL 94	V0
Test standards	EN 61643-21/A1 / IEC 61643-21/A1

Ordering data			
Type	Order No.	Pcs. / Pkt.	
PT 5-HF- 5 DC-ST	2838762	10	
PT 5-HF-12 DC-ST	2838775	10	
PT 5-HF-24DC-ST	2906002	1	
PT 2X2-BE	2839208	10	
PT 2X2+F-BE	2839224	10	

Ordering data			
Type	Order No.	Pcs. / Pkt.	
PT 3-PB-ST	2858030	10	
PT 3-HF-12DC-ST	2858043	10	
PT 1X2-BE	2856113	10	
PT 1X2+F-BE	2856126	10	

#### Accessories

Grounding connector, for MCR-PLUGTRAB base elements	
Shield fast connection	
For $\varnothing$ 3-6 mm	SSA 3-6
For $\varnothing$ 5-10 mm	SSA 5-10

Type	Order No.	Pcs. / Pkt.
PT MCR-EST	2880749	10
SSA 3-6	2839295	10
SSA 5-10	2839512	10

Type	Order No.	Pcs. / Pkt.
PT MCR-EST	2880749	10
SSA 3-6	2839295	10
SSA 5-10	2839512	10



2 x 2-wire protection for 2-wire bus system



2 x 2-wire protection for FOUNDATION Fieldbus



3-wire protection for DSL (ISDN U<sub>k0</sub>) applications with common reference potential

ERC  
Ex:

ERC  
Ex:

ERC

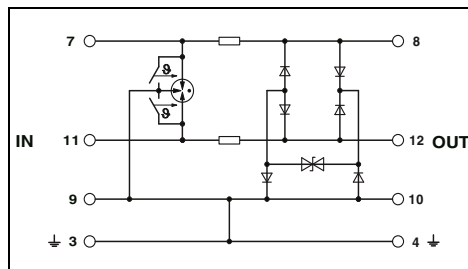
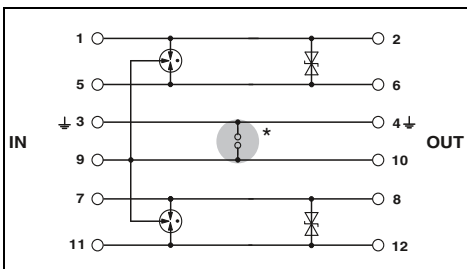
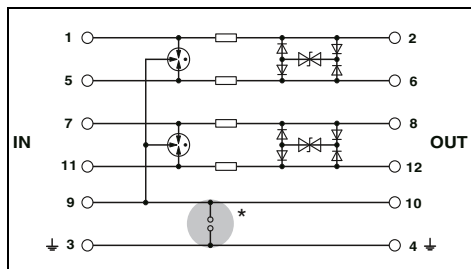

### Technical data

### Technical data

### Technical data

... 3-PB	... 3-HF	
C1 / C2 / C3 / D1	C1 / C2 / C3 / D1	C1 / C2 / C3 / D1
5.2 V DC / 3.6 V AC	13 V DC / 9 V AC	28 V DC / 19.8 V AC
2.5 kA	2.5 kA	2.5 kA
450 mA (45°C)	450 mA (45°C)	450 mA (45°C)
10 kA / 10 kA	10 kA / 10 kA	10 kA / 10 kA
20 kA	20 kA	20 kA
≤ 15 V	≤ 25 V	≤ 45 V
-	-	-
typ. 70 MHz	typ. 70 MHz	typ. 70 MHz
2.2 Ω	2.2 Ω	2.2 Ω

... 32DC
C1 / C2 / C3 / D1
36 V DC
1 kA
1.6 A
100 A / 10 kA
≤ 75 V
-
-
-

C1 / C2 / C3 / D1 / B2
185 V DC / 130 V AC
1 kA
450 mA (45°C)
10 kA / 10 kA
20 kA
≤ 300 V
≤ 300 V
typ. 20 MHz
-

17.7 mm / 45 mm / 52 mm  
0.2 ... 4 mm<sup>2</sup> / 0.2 ... 2.5 mm<sup>2</sup> / 24 - 12  
-40°C ... 85°C  
IP20  
V0  
IEC 61643-21

17.7 mm / 90 mm / 65.5 mm  
- / - / -  
-40°C ... 85°C  
IP20  
V0  
EN 61643-21/A1

17.7 mm / 90 mm / 65.5 mm  
0.2 ... 4 mm<sup>2</sup> / 0.2 ... 2.5 mm<sup>2</sup> / 24 - 12  
-40°C ... 85°C  
IP20  
V0  
IEC 61643-21 / DIN EN 61643-21

### Ordering data

### Ordering data

### Ordering data

Type	Order No.	Pcs. / Pkt.
PT 2X2-HF-5 DC-ST	2839567	10
PT 2X2-HF-12 DC-ST	2839570	10
PT 2X2-HF-24 DC-ST	2839729	10
PT 2X2-BE	2839208	10
PT 2X2+F-BE	2839224	10

Type	Order No.	Pcs. / Pkt.
PT 2X2-FF-ST	2800755	10
PT 4-BE	2839402	10
PT 4+F-BE	2839415	10

Type	Order No.	Pcs. / Pkt.
PT 2-TELE	2882828	10

### Accessories

### Accessories

### Accessories

PT MCR-EST	2880749	10
SSA 3-6	2839295	10
SSA 5-10	2839512	10

PT MCR-EST	2880749	10
SSA 3-6	2839295	10
SSA 5-10	2839512	10

PT MCR-EST	2880749	10
SSA 3-6	2839295	10
SSA 5-10	2839512	10

# Surge protection and interference suppression filters

## Surge protection for MCR technology

### LINETRAB LIT

- Protection of up to four signal wires with an overall width of 6.2 mm
- Can be used in binary, analog, and intrinsically safe circuits

**i** Your web code: #0157



Double wire (loop), floating, e.g., for 4 ... 20 mA current loops



2 double wires (loops), floating, e.g., for 4 ... 20 mA current loops

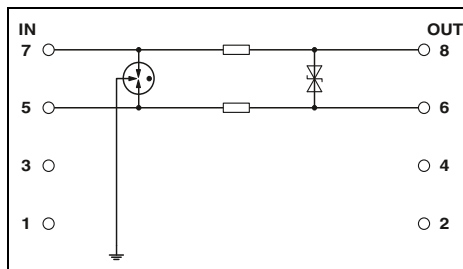

#### Technical data

<b>Electrical data</b>	
IEC test classification/EN type	C1 / C2 / C3 / D1
Maximum continuous operating voltage $U_C$	36 V DC / 25 V AC
Impulse discharge curr. $I_{imp}$ (10/350) $\mu$ s	500 A
Nominal current $I_N$	350 mA (40°C)
Nominal discharge current $I_n$ (8/20) $\mu$ s	5 kA / 5 kA
Total surge current (8/20) $\mu$ s	20 kA
Protection level $U_p$	$\leq 50$ V (C3 - 10 A) / $\leq 650$ V (C1 - 500 V / 250 A)
Cut-off frequency $f_g$ (3 dB)	typ. 6 MHz
Resistance per path	3.3 $\Omega$
<b>General data</b>	
Dimensions W / H / D	6.2 mm / 93 mm / 102.5 mm
Connection data solid / stranded / AWG	0.14 ... 2.5 mm <sup>2</sup> / 0.2 ... 2.5 mm <sup>2</sup> / 26 - 12
Temperature range	-40°C ... 80°C
Degree of protection in acc. with IEC 60529/EN 60529	IP20
Inflammability class in acc. with UL 94	V-0
Test standards	EN 61643-21/A2 / EN 60079-0 / EN 60079-11 / EN 60079-26 / IEC 60079-0 / IEC 60079-11
<b>Safety data</b>	
EC-type examination certificate according to ATEX	KEMA 09ATEX0051 X
Identification according to ATEX	Ex II 1 G Ex ia IIC T4...T6 Ex II 1 D Ex iaD 20 T85°C...135°C
Maximum inner capacitance $C_i$	1.3 nF
Maximum inner inductance $L_i$	< 1 $\mu$ H
Maximum input current $I_i$	350 mA (T4 / $\leq 80^\circ$ C)
Maximum input voltage $U_i$	36 V DC
Maximum input power $P_i$	3 W

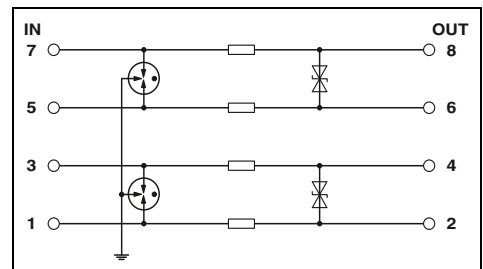

#### Technical data

<b>Electrical data</b>	
IEC test classification/EN type	C1 / C2 / C3 / D1
Maximum continuous operating voltage $U_C$	36 V DC / 25 V AC
Impulse discharge curr. $I_{imp}$ (10/350) $\mu$ s	500 A
Nominal current $I_N$	350 mA (40°C)
Nominal discharge current $I_n$ (8/20) $\mu$ s	5 kA / 5 kA
Total surge current (8/20) $\mu$ s	20 kA
Protection level $U_p$	$\leq 50$ V (C3 - 10 A) / $\leq 650$ V (C1 - 500 V / 250 A)
Cut-off frequency $f_g$ (3 dB)	typ. 6 MHz
Resistance per path	3.3 $\Omega$
<b>General data</b>	
Dimensions W / H / D	6.2 mm / 93 mm / 102.5 mm
Connection data solid / stranded / AWG	0.14 ... 2.5 mm <sup>2</sup> / 0.2 ... 2.5 mm <sup>2</sup> / 26 - 12
Temperature range	-40°C ... 80°C
Degree of protection in acc. with IEC 60529/EN 60529	IP20
Inflammability class in acc. with UL 94	V-0
Test standards	EN 61643-21/A2 / EN 60079-0 / EN 60079-11 / EN 60079-26 / IEC 60079-0 / IEC 60079-11
<b>Safety data</b>	
EC-type examination certificate according to ATEX	KEMA 09ATEX0051 X
Identification according to ATEX	Ex II 1 G Ex ia IIC T4...T6 Ex II 1 D Ex iaD 20 T85°C...135°C
Maximum inner capacitance $C_i$	1.3 nF
Maximum inner inductance $L_i$	< 1 $\mu$ H
Maximum input current $I_i$	350 mA (T4 / $\leq 80^\circ$ C)
Maximum input voltage $U_i$	36 V DC
Maximum input power $P_i$	3 W

#### Ordering data

Description	Voltage $U_N$	Type	Order No.	Pcs. / Pkt.
LINETRAB	12 V DC 24 V DC	LIT 1X2-24	2804610	10

#### Ordering data

Description	Voltage $U_N$	Type	Order No.	Pcs. / Pkt.
LINETRAB	12 V DC 24 V DC	LIT 2X2-24	2804623	10

#### Accessories

System adapter, for MINI Analog modules with screw connection	MINI MCR-SL-V8-FLK 16-A	2811268	1
VARIOFACE system cable for connecting LIT and MINI Analog via system adapter	VIP-CAB-FLK16/FR/FR/0,14/2,0M	2900156	1
Cable length: 2 m	VIP-CAB-FLK16/FR/FR/0,14/1,0M	2900155	1
Cable length: 1 m	VIP-CAB-FLK16/FR/FR/0,14/0,5M	2900154	1
Cable length: 0.5 m			
DIN rail connector			

#### Accessories

System adapter, for MINI Analog modules with screw connection	MINI MCR-SL-V8-FLK 16-A	2811268	1
VARIOFACE system cable for connecting LIT and MINI Analog via system adapter	VIP-CAB-FLK16/FR/FR/0,14/2,0M	2900156	1
Cable length: 2 m	VIP-CAB-FLK16/FR/FR/0,14/1,0M	2900155	1
Cable length: 1 m	VIP-CAB-FLK16/FR/FR/0,14/0,5M	2900154	1
Cable length: 0.5 m			
DIN rail connector			



SIL  
evaluated  
IEC 61508



2-wire, with common reference potential, e.g., for binary signals



SIL  
evaluated  
IEC 61508



4-wire, with common reference potential, e.g., for binary signals



SIL  
evaluated  
IEC 61508



4-wire, floating, impedance-free, e.g., for temperature measurement

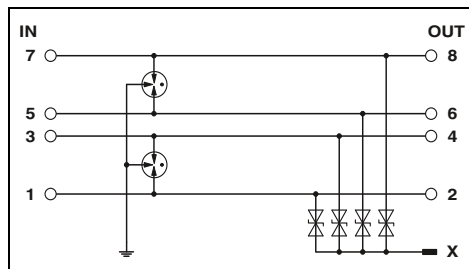
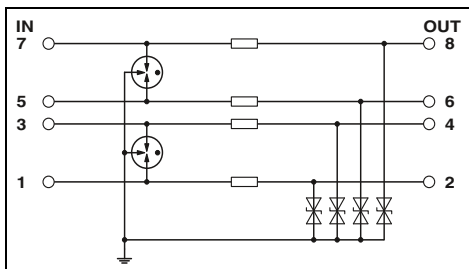
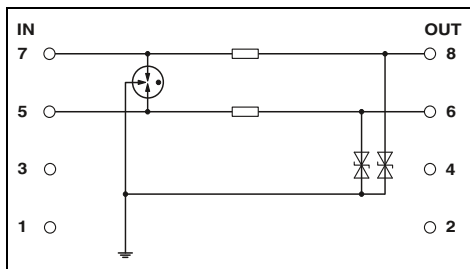

### Technical data

### Technical data

### Technical data

C1 / C2 / C3 / D1  
36 V DC / 25 V AC  
500 A  
350 mA (40°C)

- / 5 kA  
20 kA

/ ≤ 60 V (C1 - 500 V / 250 A)

-  
3.3 Ω

6.2 mm / 93 mm / 102.5 mm  
0.14 ... 2.5 mm<sup>2</sup> / 0.2 ... 2.5 mm<sup>2</sup> / 26 - 12  
-40°C ... 80°C  
IP20  
V0  
IEC 61643-21 / DIN EN 61643-21

C1 / C2 / C3 / D1  
36 V DC / 25 V AC  
500 A  
350 mA (40°C)

- / 5 kA  
20 kA

/ ≤ 60 V (C1 - 500 V / 250 A)

-  
3.3 Ω

6.2 mm / 93 mm / 102.5 mm  
0.14 ... 2.5 mm<sup>2</sup> / 0.2 ... 2.5 mm<sup>2</sup> / 26 - 12  
-40°C ... 80°C  
IP20  
V0  
IEC 61643-21 / DIN EN 61643-21

C1 / C2 / C3 / D1  
18 V DC / 13 V AC  
500 A  
500 mA (40°C)

350 A / 5 kA  
20 kA

≤ 50 V (C3 - 10 A) /  
≤ 650 V (C2 - 10 kV / 5 kA)

typ. 5 MHz  
0 Ω

6.2 mm / 93 mm / 102.5 mm  
0.14 ... 2.5 mm<sup>2</sup> / 0.2 ... 2.5 mm<sup>2</sup> / 26 - 12  
-40°C ... 80°C  
IP20  
V-0  
EN 61643-21/A2 / EN 60079-0 / EN 60079-11 /  
EN 60079-26 / IEC 60079-0 / IEC 60079-11

C1 / C2 / C3 / D1  
36 V DC / 25 V AC  
500 A  
500 mA (40°C)

250 A / 5 kA  
20 kA

≤ 60 V (C3 - 10 A) /  
≤ 650 V (C2 - 10 kV / 5 kA)

typ. 7.7 MHz  
0 Ω

KEMA 09ATEX0051 X  
Ex II 1 G Ex ia IIC T4...T6  
Ex II 1 D Ex iaD 20  
T85°C...135°C  
6 nF  
< 1 μH  
500 mA (T4 / -40...+80°C)  
18 V DC  
550 mW

KEMA 09ATEX0051 X  
Ex II 1 G Ex ia IIC T4...T6  
Ex II 1 D Ex iaD 20  
T85°C...135°C  
2.5 nF  
< 1 μH  
500 mA (T4 / -40...+80°C)  
36 V DC  
550 mW

### Ordering data

### Ordering data

### Ordering data

Type	Order No.	Pcs. / Pkt.
LIT 2X1-24	2804636	10

Type	Order No.	Pcs. / Pkt.
LIT 4X1-24	2804649	10

Type	Order No.	Pcs. / Pkt.
LIT 4-12	2804704	10
LIT 4-24	2804678	10

### Accessories

### Accessories

### Accessories

--	--	--

--	--	--

ME 6,2 TBUS-2 1,5/5-ST-3,81KMGY	2969401	10
---------------------------------	---------	----

# Surge protection and interference suppression filters

## Surge protection for MCR technology

### Modular terminal blocks with multi-stage surge protection TERMITRAB

- Multi-stage modular terminal blocks with screw connection technology
- Versions with and without disconnect knife
- To terminate a row of TERMITRAB TT... devices, covers are available in the corresponding colors

### TTEX(I)-...

- Use in Ex protection zones 1 and 2
- Wires can be led through to Ex protection zone 0



Double wire (loop), floating, e.g., for 4 ... 20 mA current loops

ERC

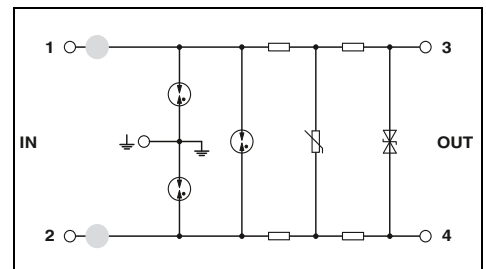

#### Technical data

	... M-24DC			... 24DC			... 110AC		
	C1 / C2 / C3 / D1			C1 / C2 / C3 / D1			C1 / C2 / C3 / D1		
Maximum continuous operating voltage $U_c$	DC / AC			30 V DC / 21 V AC			30 V DC / - / 120 V AC		
Impulse discharge curr. $I_{imp}$ (10/350) $\mu$ s	Per path			500 A			500 A		
Rated load current $I_L$	300 mA (40°C)			300 mA (40°C)			300 mA (30°C)		
Nominal discharge current $I_n$ (8/20) $\mu$ s	Core-Core / Core-Ground			5 kA / 5 kA			5 kA / 5 kA		
Total surge current (8/20) $\mu$ s	10 kA			10 kA			10 kA		
Output voltage limitation at 1 kV/ $\mu$ s	Core-Core / Core-Ground			$\leq 45$ V / $\leq 650$ V			$\leq 45$ V / $\leq 650$ V		
Cut-off frequency $f_g$ (3 dB)	Symmetrical / asymmetrical in the 50 $\Omega$ system			typ. 6 MHz / - 3.3 $\Omega$			typ. 3 MHz / - 3.7 $\Omega$		
Resistance per path				typ. 15 MHz / - 9.4 $\Omega$					
<b>General data</b>									
Dimensions W / H / D (with disconnect knife)				6.2 mm / 92 mm / 66.45 mm					
Dimensions W / H / D (without disconnect knife)				6.2 mm / 79.6 mm / 54.6 mm					
Connection data solid / stranded / AWG				0.2 ... 2.5 mm <sup>2</sup> / 0.2 ... 2.5 mm <sup>2</sup> / 24 - 14					
Temperature range				-40°C ... 80°C					
Degree of protection in acc. with IEC 60529/EN 60529				IP20					
Inflammability class in acc. with UL 94				V-2					
Test standards				IEC 61643-21/A1 / EN 61643-21/A1					
<b>Safety data</b>									
EC-type examination certificate according to ATEX	-			-			-		
Identification according to ATEX	-			-			-		
Approvals according to IECEx									
Maximum inner capacitance $C_i$	-			-			-		
Maximum inner inductance $L_i$	-			-			-		
Maximum input current $I_i$	-			-			-		
Maximum input voltage $U_i$	-			-			-		
Maximum input power $P_i$	-			-			-		

#### Ordering data

Description	Voltage $U_N$	Type	Order No.	Pcs. / Pkt.
<b>TERMITRAB</b> , modular terminal block with integrated surge protection, for mounting on NS 35				
With disconnect knife	24 V DC	TT-2-PE-M-24DC	2920641	14
Without disconnect knife	24 V DC	TT-2-PE- 24DC	2838186	10
Without disconnect knife	110 V AC	TT-2-PE-110AC	2858483	10

#### Accessories

<b>Cover</b> , for terminating a row of terminal blocks				
For terminal blocks with disconnect knife		TT-D-2-PE-M-BK	2920654	50
For terminal blocks without disconnect knife		D-DEK 1,5 BK	2838995	50



Double wire (loop), floating, e.g., for temperature measurement



2-wire, with common reference potential, e.g., for binary signals

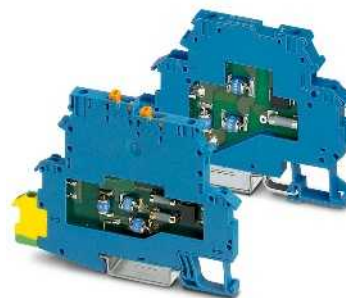

Double wire (loop), intrinsically safe, e.g., for 4 ... 20 mA current loops

ERC

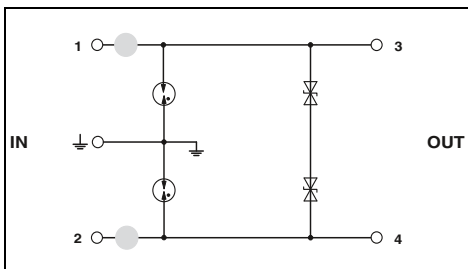

ERC

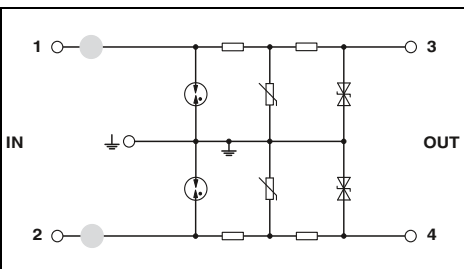

ERC

Ex:

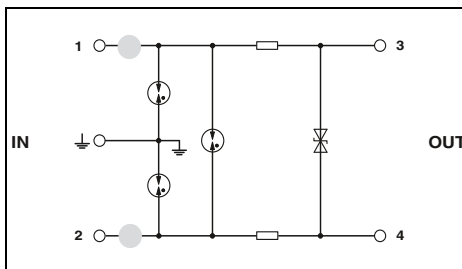

Technical data	
... M-24DC C1 / C2 / C3 / D1	... 24DC C1 / C2 / C3 / D1
30 V DC / 21 V AC 500 A 10 A (40°C)	30 V DC / 21 V AC 500 A 10 A (40°C)
300 A / 5 kA 10 kA	300 A / 5 kA 10 kA
≤ 45 V / ≤ 650 V	≤ 45 V / ≤ 700 V
typ. 7 MHz / -	typ. 6 MHz / -

Technical data	
... M-24DC C1 / C2 / C3 / D1	... 24DC C1 / C2 / C3 / D1
30 V DC / 21 V AC 500 A 300 mA (40°C)	30 V DC / - 500 A 300 mA (40°C)
5 kA / 5 kA 10 kA	- / 5 kA 10 kA
- / ≤ 45 V	- / ≤ 50 V
- / typ. 6 MHz 4.7 Ω	- / typ. 1.5 MHz 6.6 Ω

Technical data	
... M-24DC C1 / C2 / C3 / D1	... 24DC C1 / C2 / C3 / D1
30 V DC / 21 V AC 500 A 250 mA (40°C)	30 V DC / 21 V AC 500 A 250 mA (40°C)
5 kA / 5 kA 10 kA	5 kA / 5 kA 10 kA
≤ 44 V / ≤ 1.5 kV	≤ 50 V / ≤ 1.7 kV
typ. 6 MHz / - 4.7 Ω	typ. 6 MHz / - 4.7 Ω

6.2 mm / 92 mm / 66.45 mm	6.2 mm / 79.6 mm / 54.6 mm
0.2 ... 2.5 mm <sup>2</sup> / 0.2 ... 2.5 mm <sup>2</sup> / 24 - 14	0.2 ... 2.5 mm <sup>2</sup> / 0.2 ... 2.5 mm <sup>2</sup> / 24 - 14
-40°C ... 80°C	-40°C ... 80°C
IP20	IP20
V2	V2
DIN EN 61643-21	IEC 61643-21
-	-
-	-
-	-
-	-
-	-
-	-
-	-
-	-

6.2 mm / 92 mm / 66.45 mm	6.2 mm / 79.6 mm / 54.6 mm
0.2 ... 2.5 mm <sup>2</sup> / 0.2 ... 2.5 mm <sup>2</sup> / 24 - 14	0.2 ... 2.5 mm <sup>2</sup> / 0.2 ... 2.5 mm <sup>2</sup> / 24 - 14
-40°C ... 80°C	-40°C ... 80°C
IP20	IP20
V2	V2
IEC 61643-21	IEC 61643-21
-	-
-	-
-	-
-	-
-	-
-	-
-	-

6.2 mm / 92 mm / 66.45 mm	6.2 mm / 79.6 mm / 54.6 mm
0.2 ... 4 mm <sup>2</sup> / 0.2 ... 2.5 mm <sup>2</sup> / 24 - 14	0.2 ... 2.5 mm <sup>2</sup> / 0.2 ... 2.5 mm <sup>2</sup> / 24 - 14
-40°C ... 80°C	-40°C ... 80°C
IP20	IP20
V-2	V-2
EN 61643-21/A2 / EN 60079-0 / EN 60079-11 /	EN 61643-21/A2 / EN 60079-0 / EN 60079-11 /
KEMA 99ATEX5687 X	KEMA 99ATEX5687 X
II 1G Ex ia IIC T4...T6 Ga	II 1G Ex ia IIC T4...T6 Ga
II 1D Ex ia IIC	II 1D Ex ia IIC
T135°C...T85°C Da	T135°C...T85°C Da
Ex ia IIC T4...T6 Ga	Ex ia IIC T4...T6 Ga
Ex ia IIC T135°C...T85°C Da	Ex ia IIC T135°C...T85°C Da
2 nF	2 nF
1 μH	1 μH
250 mA	250 mA (T <sub>a</sub> < 40°C)
30 V	30 V
0.75 W	0.75 W

Ordering data		
Type	Order No.	Pcs. / Pkt.
TT-2-PE/S1-M-24DC	2920638	14
TT-2-PE/S1-24DC	2839538	10

Ordering data		
Type	Order No.	Pcs. / Pkt.
TT-2/2-M-24DC	2920722	14
TT-2/2-24DC	2838173	10

Ordering data		
Type	Order No.	Pcs. / Pkt.
TT-EX(I)-M-24DC	2803865	14
TT-EX(I)-24DC	2832124	10

Accessories		
TT-D-2-PE-M-BK	2920654	50
D-DEK 1,5 BK	2838995	50

Accessories		
TT-D-2-PE-M-BK	2920654	50
D-DEK 1,5 BK	2838995	50

Accessories		
TT-D-2-PE-M-BU	2803878	50
D-DEK 1,5 BU	2838982	50

# Surge protection and interference suppression filters

## Surge protection for MCR technology

### Modular terminal blocks with multi-stage surge protection **TERMITRAB**

- Multi-stage modular terminal blocks with spring-cage connection
- Versions with and without disconnect knife
- To terminate a row of TERMITRAB TT... devices, covers are available in the corresponding colors

### TT-ST-M-EX(I)-24D

- Can be used in Ex protection zones 1 and 2
- Wires can be led through to Ex protection zone 0



Double wire (loop), floating, e.g., for 4 ... 20 mA current loops

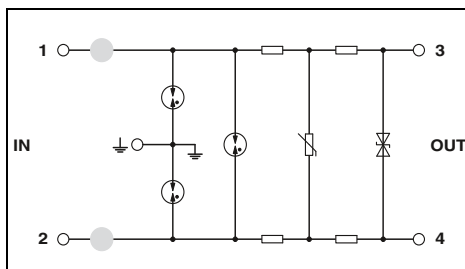

#### Technical data

Electrical data	... M...24AC	... M...24DC	... 24DC
IEC test classification/EN type	C1 / C2 / C3 / D1	C1 / C2 / C3 / D1	C1 / C2 / C3 / D1
Maximum continuous operating voltage $U_c$	DC / AC 45 V DC / 31 V AC	DC / AC 30 V DC / 21 V AC	DC / AC 30 V DC / 21 V AC
Impulse discharge curr. $I_{imp}$ (10/350) $\mu$ s	Per path 1 kA	1 kA	1 kA
Rated load current $I_L$	350 mA (45°C)	350 mA (45°C)	350 mA (45°C)
Nominal discharge current $I_n$ (8/20) $\mu$ s			
Total surge current (8/20) $\mu$ s	Core-Core / Core-Ground 5 kA / 5 kA	5 kA / 5 kA	5 kA / 5 kA
Output voltage limitation at 1 kV/ $\mu$ s	10 kA	10 kA	10 kA
Cut-off frequency $f_g$ (3 dB)	Core-Core / Core-Ground $\leq 55$ V / $\leq 600$ V	$\leq 40$ V / $\leq 600$ V	$\leq 40$ V / $\leq 600$ V
Resistance per path	Symmetrical / asymmetrical in the 50 $\Omega$ system 3.5 MHz / - 6.6 $\Omega$	typ. 3 MHz / - 6.6 $\Omega$	3 MHz / - 6.6 $\Omega$

General data	... M...24AC	... M...24DC	... 24DC
Dimensions W / H / D (with disconnect knife)		6.2 mm / 100 mm / 63.5 mm	
Dimensions W / H / D (without disconnect knife)		6.2 mm / 100 mm / 63.5 mm	
Connection data solid / stranded / AWG		0.2 ... 4 mm <sup>2</sup> / 0.2 ... 2.5 mm <sup>2</sup> / 24 - 12	
Temperature range		-40°C ... 85°C	
Degree of protection in acc. with IEC 60529/EN 60529		IP20	
Inflammability class in acc. with UL 94		V2	
Test standards		IEC 61643-21/A1 / EN 61643-21/A1	

Safety data	... M...24AC	... M...24DC	... 24DC
EC-type examination certificate according to ATEX	-	-	-
Identification according to ATEX	-	-	-
Approvals according to IECEx	-	-	-
Maximum inner capacitance $C_i$	-	-	-
Maximum inner inductance $L_i$	-	-	-
Maximum input current $I_i$	-	-	-
Maximum input voltage $U_i$	-	-	-
Maximum input power $P_i$	-	-	-

#### Ordering data

Description	Voltage $U_N$
<b>TERMITRAB</b> , spring-cage modular terminal block with integrated surge protection, for mounting on NS 35	
Without disconnect knife	12 V DC
With disconnect knife	24 V DC
Without disconnect knife	24 V DC
With disconnect knife	24 V AC
	24 V AC

#### Accessories

Cover, for terminating a row of terminal blocks	Order No.	Pcs. / Pkt.
TT-D-STTCO-BK	2858894	50

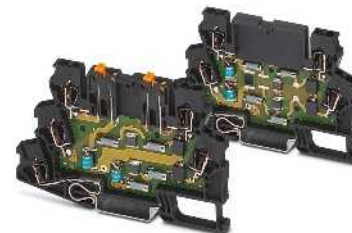

2-wire, with common reference potential, e.g., for binary signals

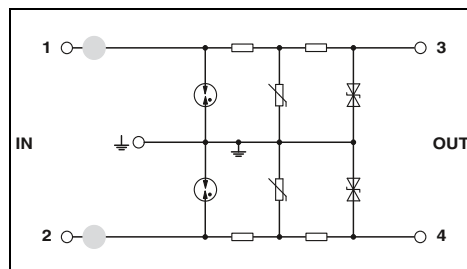

#### Technical data

Electrical data	... M...24AC	... M...24DC	... 24DC
IEC test classification/EN type	C1 / C2 / C3 / D1	C1 / C2 / C3 / D1	C1 / C2 / C3 / D1
Maximum continuous operating voltage $U_c$	DC / AC 45 V DC / 31 V AC	DC / AC 30 V DC / 21 V AC	DC / AC 30 V DC / 21 V AC
Impulse discharge curr. $I_{imp}$ (10/350) $\mu$ s	Per path 1 kA	1 kA	1 kA
Rated load current $I_L$	300 mA (45°C)	300 mA (45°C)	300 mA (45°C)
Nominal discharge current $I_n$ (8/20) $\mu$ s			
Total surge current (8/20) $\mu$ s	Core-Core / Core-Ground - / 5 kA	- / 5 kA	- / 5 kA
Output voltage limitation at 1 kV/ $\mu$ s	10 kA	10 kA	10 kA
Cut-off frequency $f_g$ (3 dB)	Core-Core / Core-Ground $\leq 55$ V / $\leq 600$ V	$\leq 40$ V / $\leq 600$ V	$\leq 40$ V / $\leq 600$ V
Resistance per path	Symmetrical / asymmetrical in the 50 $\Omega$ system - / typ. 3.5 MHz / 9.4 $\Omega$	- / typ. 3 MHz / 9.4 $\Omega$	- / typ. 3 MHz / 9.4 $\Omega$

General data	... M...24AC	... M...24DC	... 24DC
Dimensions W / H / D (with disconnect knife)		6.2 mm / 100 mm / 63.5 mm	
Dimensions W / H / D (without disconnect knife)		6.2 mm / 100 mm / 63.5 mm	
Connection data solid / stranded / AWG		0.2 ... 4 mm <sup>2</sup> / 0.2 ... 2.5 mm <sup>2</sup> / 24 - 12	
Temperature range		-40°C ... 85°C	
Degree of protection in acc. with IEC 60529/EN 60529		IP20	
Inflammability class in acc. with UL 94		V2	
Test standards		IEC 61643-21/A1 / EN 61643-21/A1	

Safety data	... M...24AC	... M...24DC	... 24DC
EC-type examination certificate according to ATEX	-	-	-
Identification according to ATEX	-	-	-
Approvals according to IECEx	-	-	-
Maximum inner capacitance $C_i$	-	-	-
Maximum inner inductance $L_i$	-	-	-
Maximum input current $I_i$	-	-	-
Maximum input voltage $U_i$	-	-	-
Maximum input power $P_i$	-	-	-

#### Ordering data

Description	Voltage $U_N$
<b>TERMITRAB</b> , spring-cage modular terminal block with integrated surge protection, for mounting on NS 35	
Without disconnect knife	12 V DC
With disconnect knife	24 V DC
Without disconnect knife	24 V DC
With disconnect knife	24 V AC
	24 V AC

#### Accessories

Cover, for terminating a row of terminal blocks	Order No.	Pcs. / Pkt.
TT-D-STTCO-BK	2858894	50





# Surge protection and interference suppression filters

## Surge protection for MCR technology

### Surge protection directly at the sensor head SURGETRAB

- Arresters in hexagonal tube with various outer threads
- **S-PT-1x2...** and **S-PT-EX(I)...** installation in signal path feed-through
- **S-PT-EX**, **S-PT-2xEX...**, and **S-PT-4-EX** installation in a separate cable gland parallel to the signal cables
- S-PT-EX... devices are approved for Ex-i and Ex-d measuring probes



Double wire (loop), floating, e.g., for 4 ... 20 mA current loops



Double wire (loop), intrinsically safe, e.g., for 4 ... 20 mA current loops

<b>Notes:</b>
For more information about EX approvals, visit <a href="http://phoenixcontact.com">phoenixcontact.com</a>
For additional safety data, visit <a href="http://phoenixcontact.net/products">phoenixcontact.net/products</a>

ERC

ERC

Ex:

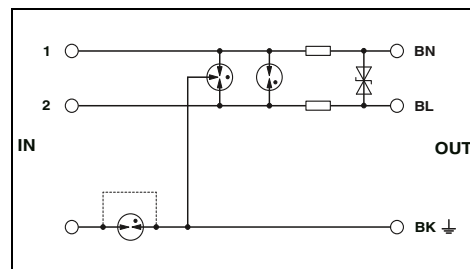
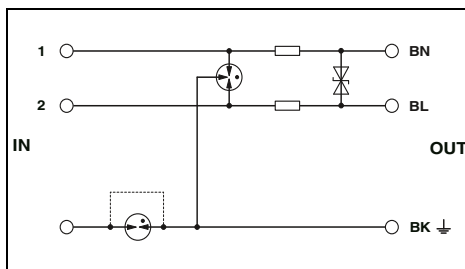

#### Technical data

#### Technical data

<b>Electrical data</b>	
Maximum continuous operating voltage $U_C$	40 V DC / 28 V AC
Impulse discharge curr. $I_{imp}$ (10/350) $\mu$ s	1 kA
Nominal current $I_N$	450 mA (55°C)
Nominal discharge current $I_n$ (8/20) $\mu$ s	
Maximum permitted short-circuit current at installation location	Core-Core / Core-Ground: 10 kA / 10 kA 1 A
Total surge current (8/20) $\mu$ s	20 kA
Protection level $U_p$	Core-Core $\leq 80$ V (C2 - 5 kA) Core-Ground
Output voltage limitation at 1 kV/ $\mu$ s	Core-Core / Core-Ground $\leq 55$ V / $\leq 450$ V (direct grounding) 2.2 $\Omega$
Resistance per path	
<b>General data</b>	
Dimensions W / H / D	34 mm / 34 mm / 137 mm
Temperature range	-40°C ... 85°C
Degree of protection in acc. with IEC 60529/EN 60529	IP67
Test standards	IEC 61643-21
<b>Safety data</b>	
EC-type examination certificate according to ATEX	-
Identification according to ATEX	-
Maximum inner capacitance $C_i$	-
Maximum inner inductance $L_i$	-
Maximum input current $I_i$	-
Maximum input voltage $U_i$	-
Maximum input power $P_i$	-

<b>Technical data</b>	
Maximum continuous operating voltage $U_C$	30 V DC / 21 V AC
Impulse discharge curr. $I_{imp}$ (10/350) $\mu$ s	1 kA
Nominal current $I_N$	350 mA (50°C)
Nominal discharge current $I_n$ (8/20) $\mu$ s	
Maximum permitted short-circuit current at installation location	10 kA / 10 kA 350 mA
Total surge current (8/20) $\mu$ s	20 kA
Protection level $U_p$	Core-Core $\leq 50$ V (C3 - 25 A) Core-Ground $\leq 1.4$ kV (C3 - 100 A)
Output voltage limitation at 1 kV/ $\mu$ s	Core-Core / Core-Ground $\leq 50$ V / $\leq 1.4$ kV (direct grounding) 2.2 $\Omega$
Resistance per path	
<b>General data</b>	
Dimensions W / H / D	34 mm / 34 mm / 137 mm
Temperature range	-40°C ... 50°C
Degree of protection in acc. with IEC 60529/EN 60529	IP67
Test standards	EN 61643-21/A2 / EN 60079-0 / EN 60079-11 / EN 60079-26 / IEC 60079-0 / IEC 60079-11
<b>Safety data</b>	
EC-type examination certificate according to ATEX	KEMA 06ATEX0002
Identification according to ATEX	II 1G Ex ia IIC T4...T6 Ga
Maximum inner capacitance $C_i$	2 nF
Maximum inner inductance $L_i$	1 $\mu$ H
Maximum input current $I_i$	350 mA (T4, T5, T6 $\leq 50^\circ$ C)
Maximum input voltage $U_i$	30 V
Maximum input power $P_i$	3 W

#### Ordering data

#### Ordering data

Description	Voltage $U_N$
<b>SURGETRAB</b> , protective adapter for installation on measuring sensors	
Outer thread: M20 x 1.5	24 V DC
Outer thread: 1/2" 14 NPT	24 V DC
Outer thread: 3/4" 14 NPT	24 V DC
<b>SURGETRAB</b> protective adapter for installation on measuring sensors for Ex protection zones	
Outer thread: M20 x 1.5	24 V DC
Outer thread: 1/2" 14 NPT	24 V DC
Outer thread: 3/4" 14 NPT	24 V DC
Outer thread: M20 x 1.5	48 V DC
Outer thread: 1/2" 14 NPT	48 V DC

Type	Order No.	Pcs. / Pkt.
S-PT-1X2-24DC	2880668	1
S-PT-1X2-24DC-1/2"	2882569	1
S-PT-1X2-24DC-3/4"	2882598	1

Type	Order No.	Pcs. / Pkt.
S-PT-EX(I)-24DC	2880671	1
S-PT-EX(I)-24DC-1/2"	2882572	1
S-PT-EX(I)-24DC-3/4"	2882585	1



**SIL**  
evaluated  
IEC 61508



Double wire (loop), floating, intrinsically safe, encapsulated, without decoupling resistance



**SIL**  
evaluated  
IEC 61508



2 double wires (loops), floating, intrinsically safe, encapsulated, without decoupling resistance



**SIL**  
evaluated  
IEC 61508



4-wire with common reference potential, intrinsically safe, encapsulated, without decoupling resistance

ERC

Ex:

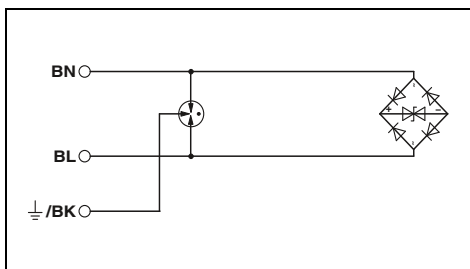

ERC

Ex:

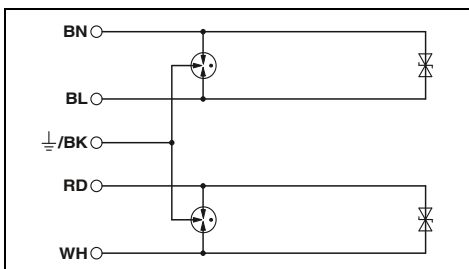

ERC

Ex:

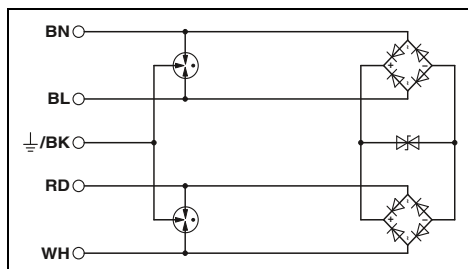

### Technical data

... 24DC	... 48DC
36 V DC / 25 V AC	53 V DC / 37 V AC
1 kA	1 kA
-	-

260 A / 10 kA	170 A / 10 kA
1 A (non-EX)	1 A (non-EX)

20 kA	20 kA
-------	-------

≤ 65 V (C3 - 10 A)	≤ 90 V (C3 - 10 A)
≤ 1.1 kV (C3 - 100 A)	≤ 1.1 kV (C3 - 100 A)

≤ 60 V / -	≤ 80 V / -
------------	------------

28 mm / 28 mm / 79 mm  
-40°C ... 80°C (non-EX)  
IP67

EN 61643-21/A2 / EN 60079-0 / EN 60079-1 /  
EN 60079-11 / EN 60079-26 / EN 60079-31

KEMA 09ATEX0028 X	KEMA 09ATEX0028 X
II 1 G Ex ia IIC T4...T6	II 1 G Ex ia IIC T4...T6
II 2 G Ex d IIC T4...T6	II 2 G Ex d IIC T4...T6
1.65 nF	1.14 nF
1 μH	1 μH
500 mA (T4 / ≤ 75°C)	500 mA (T4 / ≤ 75°C)
36 V DC	53 V DC
3 W	3 W

### Technical data

... 24DC	... 48DC
36 V DC / 25 V AC	53 V DC / 37 V AC
1 kA	1 kA
-	-

260 A / 10 kA	170 A / 10 kA
1 A (non-EX)	1 A (non-EX)

20 kA	20 kA
-------	-------

≤ 50 V (C3 - 10 A)	≤ 80 V (C3 - 10 A)
≤ 1.1 kV (C3 - 100 A)	≤ 1.1 kV (C3 - 100 A)

≤ 50 V / -	≤ 80 V / -
------------	------------

28 mm / 28 mm / 79 mm  
-40°C ... 80°C (non-EX)  
IP67

EN 61643-21/A2 / EN 60079-0 / EN 60079-1 /  
EN 60079-11 / EN 60079-26 / EN 60079-31

KEMA 09ATEX0028 X	KEMA 09ATEX0028 X
II 1 G Ex ia IIC T4...T6	II 1 G Ex ia IIC T4...T6
II 2 G Ex d IIC T4...T6	II 2 G Ex d IIC T4...T6
1.65 nF	1.14 nF
1 μH	1 μH
500 mA (T4 / ≤ 75°C)	500 mA (T4 / ≤ 75°C)
36 V DC	53 V DC
3 W	3 W

### Technical data

36 V DC / 25 V AC
1 kA
-

260 A / 10 kA
1 A (non-EX)

20 kA
-------

≤ 65 V (C3 - 10 A)
≤ 1.1 kV (C3 - 100 A)

≤ 60 V / -
------------

28 mm / 28 mm / 79 mm  
-40°C ... 80°C (non-EX)  
IP67

EN 61643-21/A2 / EN 60079-0 / EN 60079-1 /  
EN 60079-11 / EN 60079-26 / EN 60079-31

KEMA 09ATEX0028 X
II 1 G Ex ia IIC T4...T6
II 2 G Ex d IIC T4...T6
1.65 nF
1 μH
500 mA (T4 / ≤ 75°C)
36 V DC
3 W

### Ordering data

Type	Order No.	Pcs. / Pkt.
S-PT-EX-24DC	2800034	1
S-PT-EX-24DC-1/2"	2800035	1
S-PT-EX-48DC	2800053	1
S-PT-EX-48DC-1/2"	2800054	1

### Ordering data

Type	Order No.	Pcs. / Pkt.
S-PT-2XEX-24DC	2800040	1
S-PT-2XEX-24DC-1/2"	2800041	1
S-PT-2XEX-48DC	2800038	1
S-PT-2XEX-48DC-1/2"	2800039	1

### Ordering data

Type	Order No.	Pcs. / Pkt.
S-PT-4-EX-24DC	2800036	1
S-PT-4-EX-24DC-1/2"	2800037	1

# Surge protection and interference suppression filters

## Surge protection for MCR technology

### Protection of a binary signal input with actuator circuit, floating reference potential

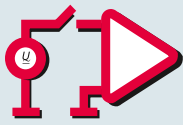

E.g.,  
24 V switched

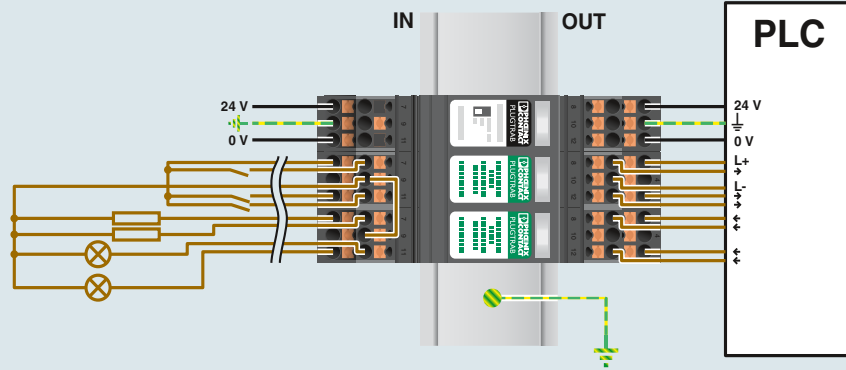

Plug-in

Push-in connection

1 x PT-IQ-PTB-PT +  
2 x PT-IQ-4X1+F-24DC-PT  
2801296 + 2801272  
Page 76

Optional screw connection

1 x PT-IQ-PTB-UT +  
2 x PT-IQ-4X1+F-24DC-UT  
2800768 + 2800983  
Page 76

### Protection of a binary signal input with actuator circuit, grounded reference potential



E.g.,  
24 V switched

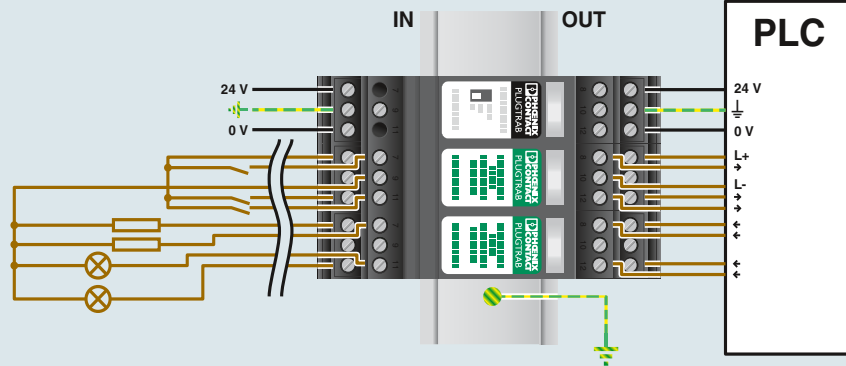

Plug-in

Screw connection

1 x PT-IQ-PTB-UT +  
2 x PT-IQ-4X1-24DC-UT  
2800768 + 2800982  
Page 76

Optional push-in connection

1 x PT-IQ-PTB-PT +  
2 x PT-IQ-4X1-24DC-PT  
2801296 + 2801271  
Page 76

### Protection of a binary signal input with actuator circuit, common grounded reference potential (negative pole)



E.g.,  
24 V switched

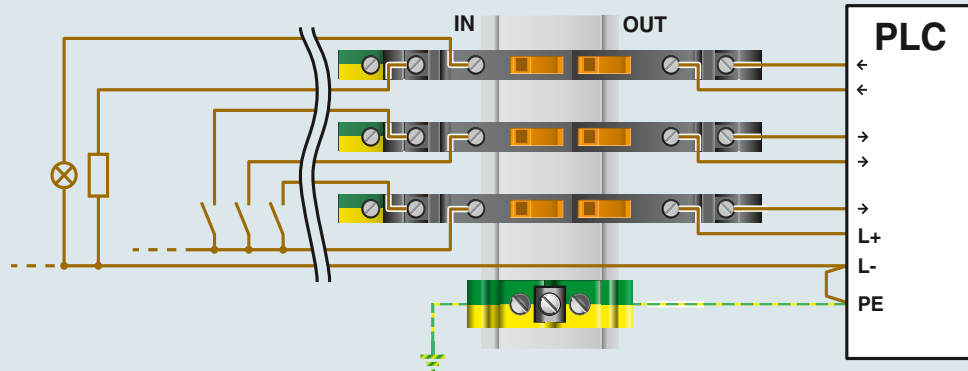

One-piece

Screw connection

TT-2/2-M-24DC  
2920722  
Page 95

Optional  
spring-cage connection

TT-ST-M-2/2-24DC  
2858917  
Page 96

### Protection of a binary signal input with actuator circuit, common floating reference potential (negative pole)



E.g.,  
24 V switched

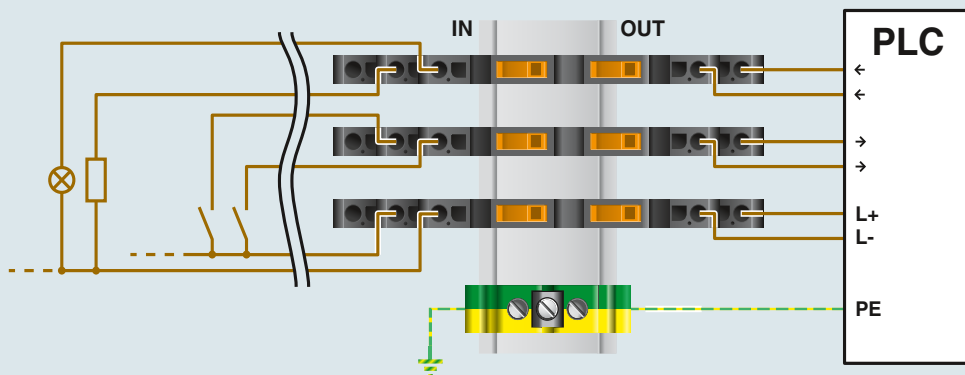

One-piece

Spring-cage connection

**TT-ST-M-2/2-24DC**

2858917  
Page 96

Optional  
screw connection

**TT-2/2-M-24DC**

2920722  
Page 95

### Protection of a four-wire measurement

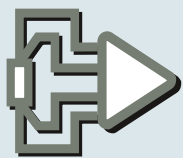

E.g.,  
temperature  
measurement

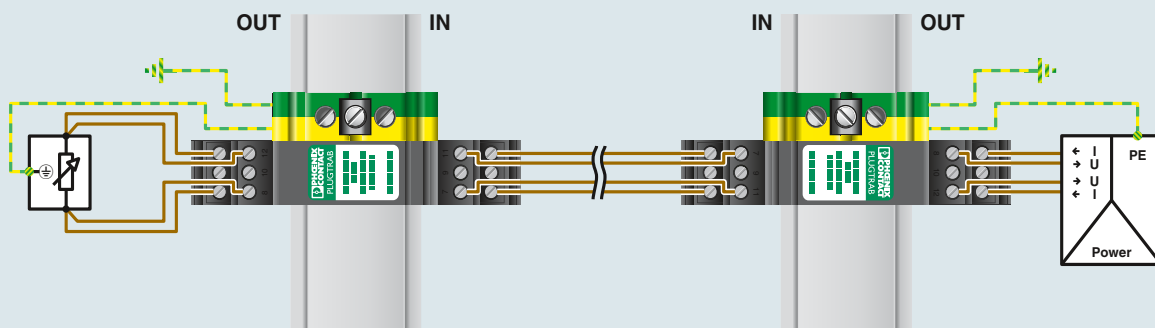

Plug-in

**PT 4-24DC-ST + PT 4-BE**

2839240 + 2839402  
Page 86

**PT 4-24DC-ST + PT 4-BE**

2839240 + 2839402  
Page 86

### Protection of a four-wire measurement, for Ex and non-Ex applications

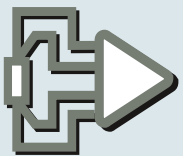

E.g.,  
temperature  
measurement

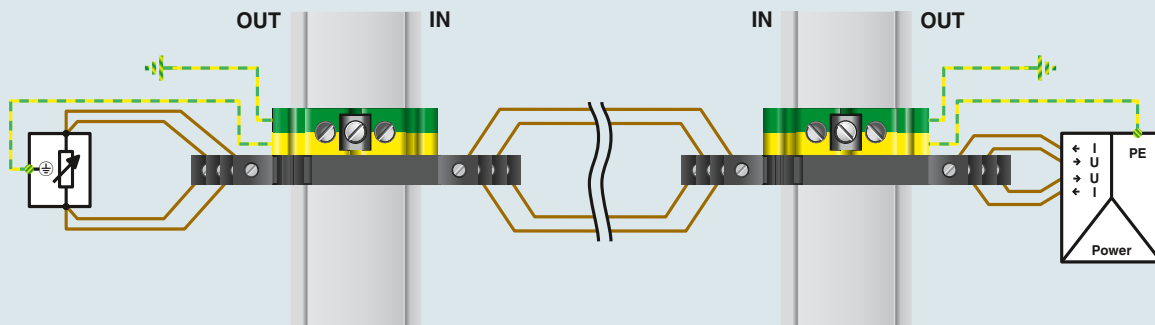

One-piece

**LIT 4-24**

2804678  
Page 93

**LIT 4-24**

2804678  
Page 93

# Surge protection and interference suppression filters

## Surge protection for MCR technology

### Protection of an analog measurement

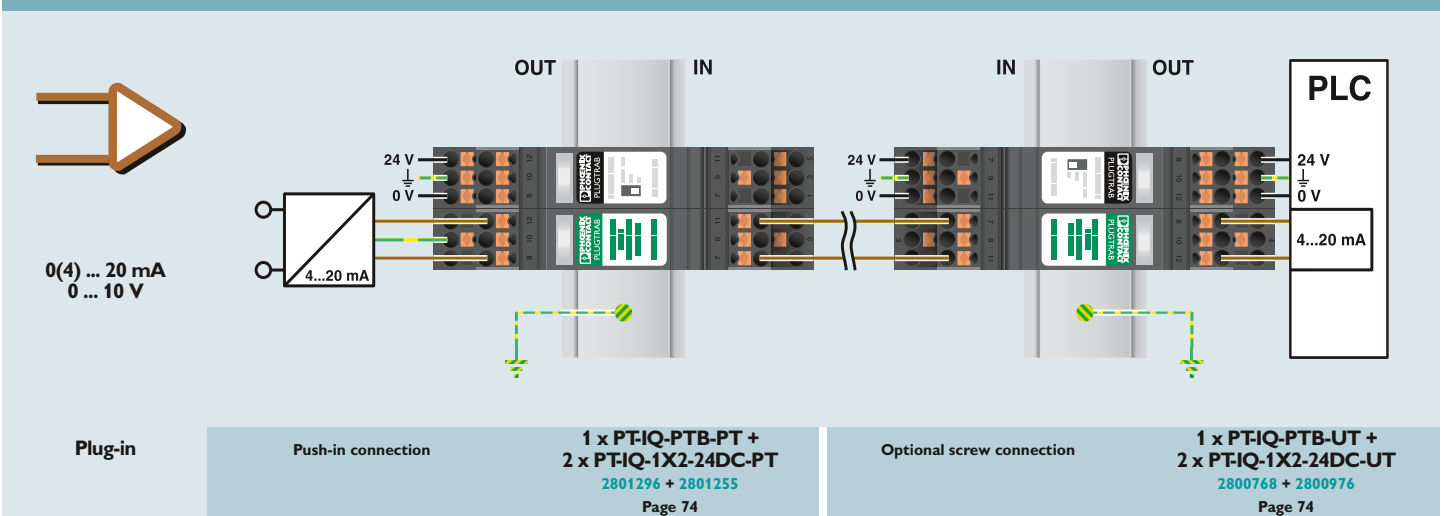

### Protection of an analog measurement

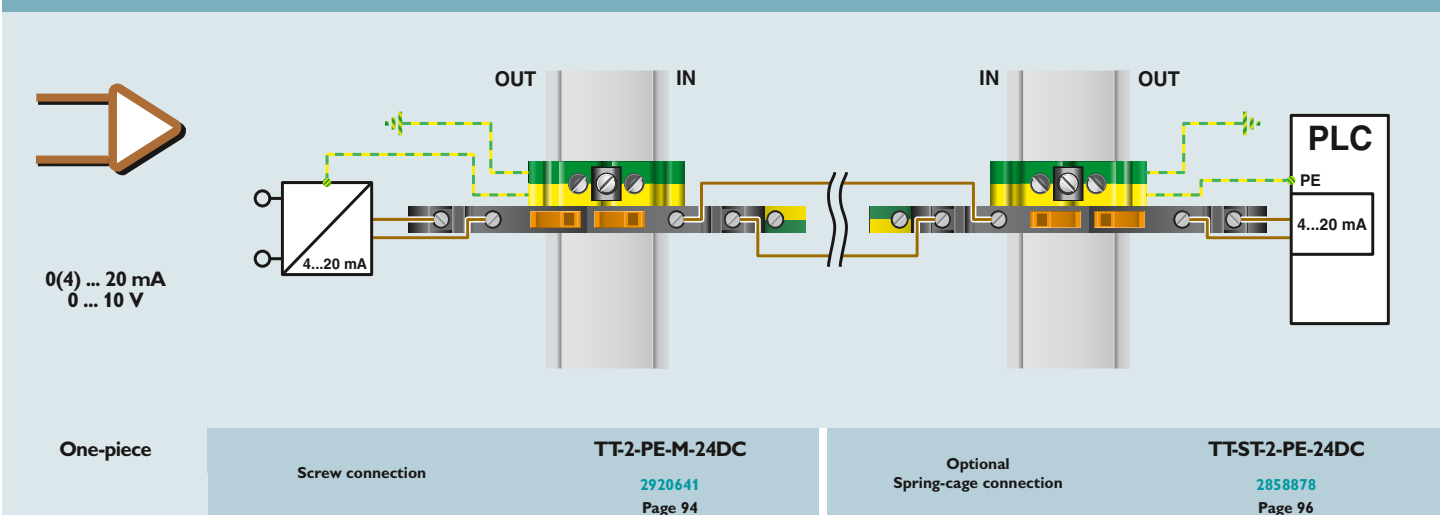

### Protection of an analog measurement, intrinsically safe circuits

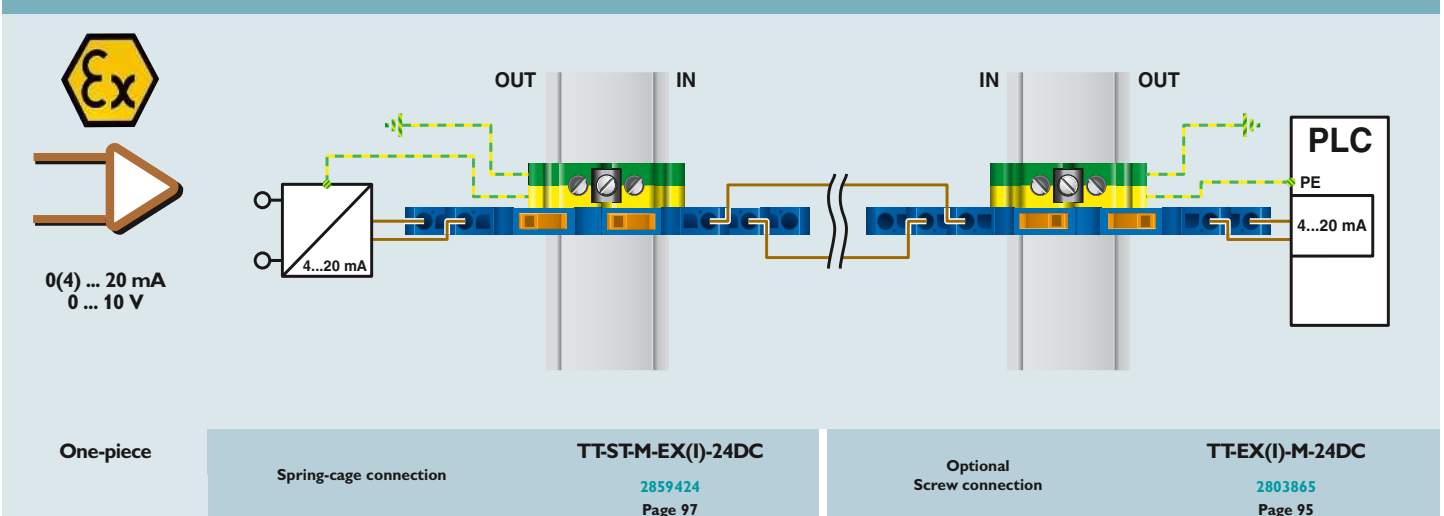

### Protection of an analog measurement, intrinsically safe circuits

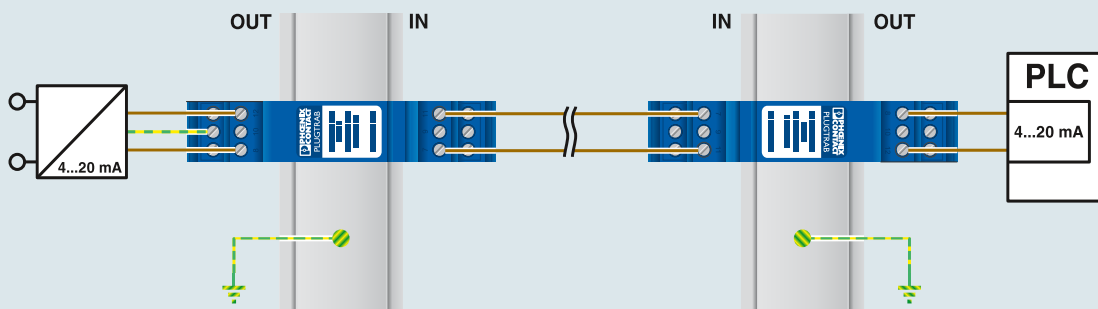

Plug-in

PT 2XEX(I)-24DC-ST + PT 2XEX(I)-BE

2838225 + 2839279  
Page 89

PT 2XEX(I)-24DC-ST + PT 2XEX(I)-BE

2838225 + 2839279  
Page 89

### Protection of an analog measurement, intrinsically safe circuits

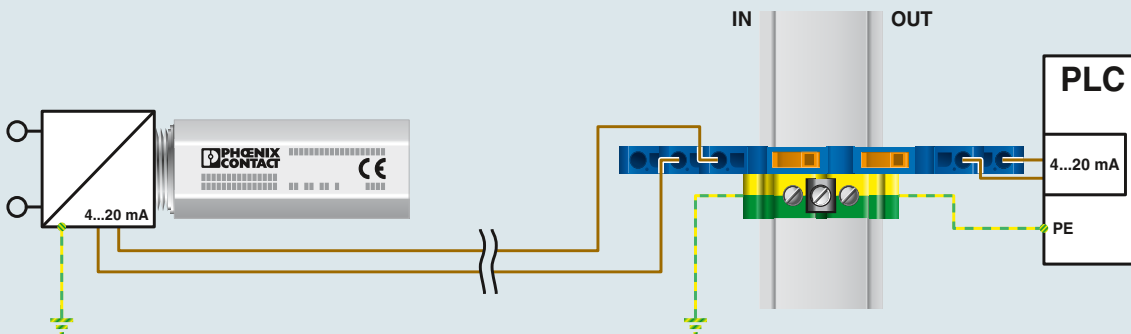

One-piece

S-PTEX-24DC

2800034  
Page 99

TT-ST-M-EX(I)- 24DC

2859424  
Page 97

### Protection of an analog measurement, intrinsically safe circuits

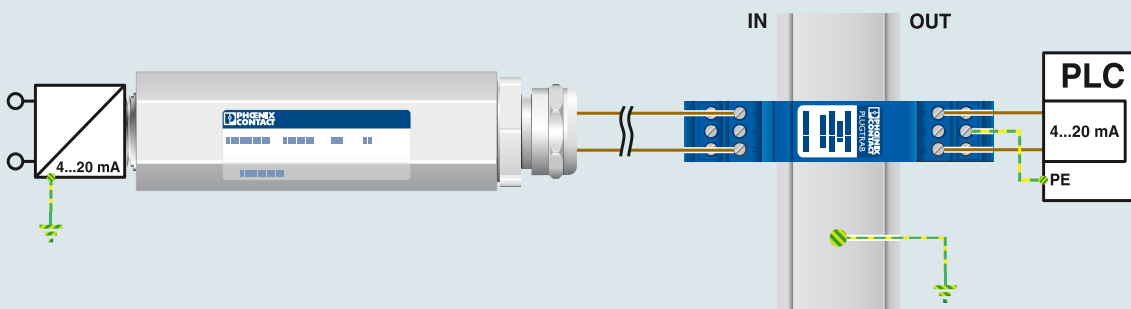

One-piece

S-PTEX(I)-24DC

2880671  
Page 98

PT 2XEX(I)-24DC-ST + PT 2XEX(I)-BE

2838225 + 2839279  
Page 89



Low signal levels at high frequencies require special protective circuits in data processing and telecommunications. The arresters must guarantee short response times to quickly limit the surge voltages to safe values, without impairing signal quality. In addition, the protective devices support system-specific connections, such as RJ45 or D-SUB connectors, and all types of network topologies.

#### **DATATRAB DT - the all-round solution for protecting data interfaces**

DATATRAB DT reliably protects high-speed networks against damage caused by surge voltages. DT-LAN-CAT.6+ supports various data protocols at very high transmission speeds, such as Ethernet, Power over Ethernet (PoE), ISDN, token ring, and DS1, in a single device.

The housing has a ground connection snap-on foot into which the ground connection cover with equipotential bonding cable is inserted. DATATRAB can be therefore used either as an adapter or a DIN rail module after removing the ground connection cover.

**i** Your web code: [#0145](#)



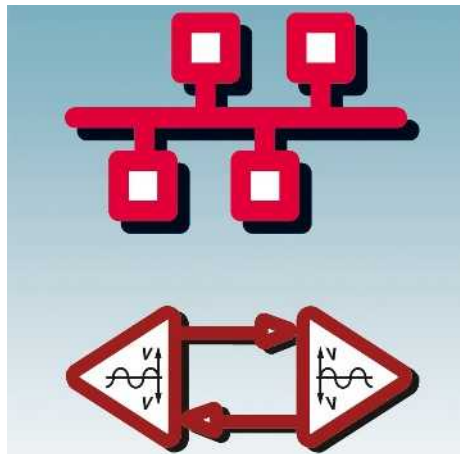

### Use

Protective devices suitable for all common applications including Ethernet, token ring, ISDN, DS1, DSL, analog telecommunications, RS-485, V.24, V.11, etc. are available.

The circuit breakers also support Power over Ethernet (PoE) in mode A and B versions.



### Speed

Used in EDP systems with a transmission speed of up to 10 Gbps (CAT6/CLASS E<sub>2</sub>) and in telecommunications networks with 50 Mbps (VDSL).



### Versatile

The DATATRAB product range can offer a suitable protective device for various applications. The protective devices are simply installed between the signal paths with interfaces for RJ11/12, RJ45, D-SUB or screw connection.



### COMTRAB modular

For protecting telecommunications systems

- Direct insertion in LSA-PLUS marshalling panels
- Coarse protection magazines with gas-filled surge arrester
- Modular miniature connectors with combined coarse and fine protection elements for optimum protection



### Other designs

Other application-specific protective devices include:

- Two-piece plug-in protective devices in the PLUGTRAB product range
- Combined adapters for the power supply and MAINTRAB interfaces

# Surge protection and interference suppression filters

## Surge protection for information technology and telecommunications

The interface matrix indicates which surge protective device is suitable for a specific interface.





























### Note:

For further interface recommendations, visit [phoenixcontact.net/products](http://phoenixcontact.net/products).

1) The PT-IQ-PTB-UT supply module is required in order to operate the PT-IQ series.

### Explanation of the IEC categories

LPZ	Test category for SPD according to IEC 61643-21	Test class for SPD according to IEC 61643-11
0/1	D1	I
1/2	C2	II
2/3	C1	III

Technology	Interface	Mounting
	CAN-BUS	
	DeviceNet™	
	Ethernet	 
	Gigabit Ethernet (1/10 GBase-T)	
	FOUNDATION Fieldbus H1	
	FOUNDATION Fieldbus Ex(i)	
	INTERBUS-INLINE (analog I/Os)	
	INTERBUS-INLINE (digital I/Os)	
	INTERBUS remote bus	
	LON (Works)	
	PROFIBUS® DP (FMS)	 
	PROFIBUS® PA (FMS)	
	PROFINET®	
	RS-422A, V.11, X.27, RS-423A	
	RS-485	
	RS-232-C/V.24	
	TTY, 0(4) - 20 mA	
	ADSL 2+, T-DSL- HDSL, VDSL	 
	DSL broadband (coax)	 
	ISDN (S <sub>0</sub> & S <sub>2M</sub> bus)	
	ISDN (U <sub>k0</sub> )	 
	SHDSL	
	Analog telephone	



### Note

Products bearing this stamp (plug elements) can be tested with the CHECKMASTER.



Connection technology	IEC category	Protected wires	Arrester	Order No.	Page
Screw terminal block	D1/C2/C1	3	PT-IQ-3-HF-12DC-UT (bus)	<a href="#">2800786</a>	78
	T3	2	PLT-SEC-T3-24-FM	<a href="#">2905223</a>	30
Screw terminal block	D1/C2/C1	3	PT-IQ-3-HF-12DC-UT (bus)	<a href="#">2800786</a>	78
	T3	2	PLT-SEC-T3-24-FM	<a href="#">2905223</a>	30
RJ45	D1/C2/C1	8	DT-LAN-CAT.6+	<a href="#">2881007</a>	108
RJ45	C2/C1	24 x 8	DT-LAN-19"	<a href="#">2838791</a>	113
RJ45	D1/C2/C1	8	DT-LAN-CAT.6+	<a href="#">2881007</a>	108
Screw terminal block	D1/C2/C1	4	PT 2X2-FF-ST & PT 4-BE	<a href="#">2800755</a> & <a href="#">2839402</a>	91
Screw terminal block	D1/C2/C1	3	PT 2XEX(I)-24DC-ST & PT 2XEX(I)-BE (bus)	<a href="#">2838225</a> & <a href="#">2839279</a>	89
	T3	2	PLT-SEC-T3-DC-24-FM	<a href="#">2905223</a>	31
Screw terminal block	D1/C2/C1	4	PT-IQ-2X2-24DC-UT <sup>1)</sup>	<a href="#">2800980</a>	76
Screw terminal block	D1/C2/C1	5	PT-IQ-4X1-24DC-UT <sup>1)</sup>	<a href="#">2800982</a>	77
D-SUB	D1/C2/C1	5	DT-UFB-IB-RBI	<a href="#">2800055</a>	111
		5	DT-UFB-IB-RBO	<a href="#">2800056</a>	111
Screw terminal block	D1/C2/C1	2	PT-IQ-1X2-48DC-UT <sup>1)</sup>	<a href="#">2800978</a>	74
Screw terminal block	D1/C2/C1	3	PT-IQ-3-PB-UT <sup>1)</sup>	<a href="#">2800785</a>	78
D-SUB	C1	2	D-UFB-PB	<a href="#">2880642</a>	112
Screw terminal block	D1/C2/C1	2	PT 2XEX(I)-24DC-ST & PT 2XEX(I)-BE (bus)	<a href="#">2838225</a> & <a href="#">2839279</a>	89
		4	PT 4-EX(I)-24DC-ST & PT 4-EX(I)-BE	<a href="#">2839253</a> & <a href="#">2839486</a>	89
RJ45	D1/C2/C1	8	DT-LAN-CAT.6+	<a href="#">2881007</a>	108
Screw terminal block	D1/C2/C1	5	PT-IQ-5-HF+F-12DC-UT <sup>1)</sup>	<a href="#">2800801</a>	79
D-SUB	D1/C2/C1	5	DT-UFB-485/BS	<a href="#">2920612</a>	110
Screw terminal block		5	PT-IQ-5-HF+F-12DC-UT <sup>1)</sup>	<a href="#">2800801</a>	79
D-SUB	C2/C1	9	DT-UFB-V24/S-9-SB	<a href="#">2803069</a>	109
		9	DT-UFB-V24/S-SB-SET	<a href="#">2803072</a>	109
Screw terminal block	D1/C2/C1	3	PT-IQ-3-HF+F-12DC-UT <sup>1)</sup>	<a href="#">2800995</a>	79
Screw terminal block	D1/C2/C1	4	PT-IQ-2X2-24DC-UT <sup>1)</sup>	<a href="#">2800980</a>	76
Screw terminal block	D1/C2/C1	4	DT-TELE-RJ45	<a href="#">2882925</a>	114
	D1/C2/C1	2	PT-IQ-1X2-TELE-UT	<a href="#">2800769</a>	80
LSA	D1/C2/C1	2	CTM 1X2-110AC & CTM 10-MAG	<a href="#">2838539</a> & <a href="#">2838610</a>	116
TAE	D1/C2/C1	4	TAE-TRAB FM-NFN-AP	<a href="#">2749628</a>	115
RJ45/TAE	D1/C2/C1 & T3	2	MNT-TEL... or MNT-TAE	<a href="#">2882404</a> / <a href="#">2882394</a>	57
Coax	D1/C2/C1	2	C-TV-SAT	<a href="#">2856993</a>	130
	D1/C2/C1 & T3	2	MNT-TV-SAT	<a href="#">2882297</a>	57
LSA	D1/C2/C1	2 x 2	CTM ISDN (2x) & CTM 10-MAG	<a href="#">2838555</a> & <a href="#">2838610</a>	117
RJ45	D1/C2/C1	4	DT-LAN-CAT.6+	<a href="#">2881007</a>	108
Screw terminal block & RJ45/RJ12	D1/C2/C1	4	DT-TELE-RJ45	<a href="#">2882925</a>	114
Screw terminal block	D1/C2/C1	2	PT 2-TELE	<a href="#">2882828</a>	91
LSA	D1/C2/C1	2	CTM 1X2-110AC & CTM 10-MAG	<a href="#">2838539</a> & <a href="#">2838610</a>	116
RJ45/TAE	D1/C2/C1 & T3	2	MNT-TEL... or MNT-TAE	<a href="#">2882404</a> / <a href="#">2882394</a>	57
Screw terminal block & RJ45/RJ12	D1/C2/C1	4	DT-TELE-SHDSL	<a href="#">2801593</a>	114
			See ADSL 2+		

# Surge protection and interference suppression filters

## Surge protection for information technology and telecommunications

### For Ethernet/PROFINET® networks as well as RS-232 interfaces

#### DT-LAN-CAT.6+

- Suitable for category 6 high-speed data networks
- Reliable transmission rates up to 10 Gbps
- Protective adapter for eight signal paths via RJ45 connector
- Can be installed in a control cabinet by removing a ground connection adapter

#### D-LAN-CAT.5-FP

- Suitable for category 5 data networks
- Reliable transmission speeds up to 1 Gbps
- Protective adapter for eight signal paths via RJ45 connector

### Protection for RS-232 interfaces

#### DT-UFB-V24/S

- Connection: 9-pos. D-SUB and 25-pos. D-SUB
- For data and handshake cables

#### Pin assignment DT-UFB-V24/S-9-SB

- 1,2,3,4,6,7,8,9 Data lines
- 5 Signal ground (ground)

#### Pin assignment DT-UFB-V24/S-SB-SET

- 2,3,4,5,6,8,20,22 Data lines
- 7 Signal ground (ground)



For LAN interfaces (Class E<sub>A</sub>/CAT6) including PoE and ISDN S<sub>0</sub> protection

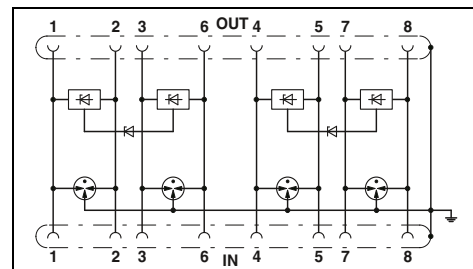

Electrical data	
IEC test classification/EN type	
Maximum continuous operating voltage U <sub>c</sub>	
Nominal current I <sub>n</sub>	
Nominal discharge current I <sub>n</sub> (8/20) μs	
Total surge current (8/20) μs	Core-Core / Core-Ground
Protection level U <sub>p</sub>	Core-Core / Core-Ground
Output voltage limitation at 1 kV/μs	Core-Core / Core-Ground
Cut-off frequency f <sub>g</sub> (3 dB)	Symmetrical
In a 100 Ω system	
General data	
Dimensions W / H / D	
Temperature range	
Degree of protection in acc. with IEC 60529/EN 60529	
Inflammability class in acc. with UL 94	
Connection method	
Test standards	

#### Technical data

B2 / C1 / C2 / C3 / D1
≤ 3.3 V DC (± 60 V DC/PoE+)
≤ 1.5 A (25°C)
100 A / 2 kA (per signal pair)
10 kA
≤ 9 V (B2 - 1 kV/25 A) /
≤ 700 V (C2 - 4 kV/2 kA)
≤ 9 V / ≤ 700 V
> 500 MHz

Description
DATATRAB adapter, protective adapter to be inserted into the data line

#### Ordering data

Type	Order No.	Pcs. / Pkt.
DT-LAN-CAT.6+	2881007	1

# Surge protection and interference suppression filters

## Surge protection for information technology and telecommunications

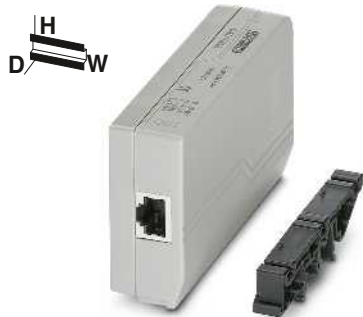

For LAN interfaces (Class D/CAT5) including PoE and ISDN S<sub>0</sub> protection

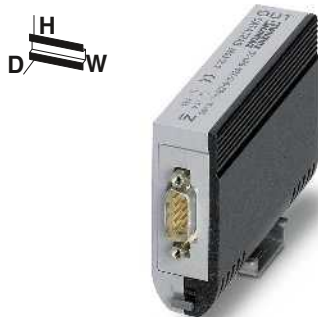

For RS-232 interfaces with D-SUB 9 connection



For RS-232 interfaces with D-SUB 9 connection

ERC

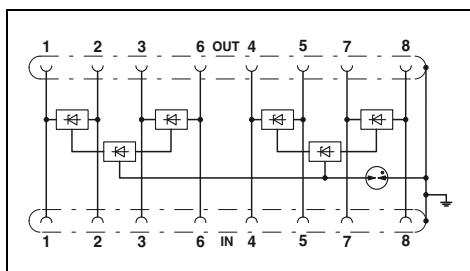

### Technical data

B2 / C1
≤ 5 V DC (±57 V DC/PoE) / -
≤ 1.5 A (25°C)
350 A / 350 A
-
≤ 35 V (C1 - 700 V/350 A) ≤ 110 V (C1 - 700 V/350 A - PoE) / -
≤ 25 V / ≤ 750 V
> 100 MHz
28 mm / 110 mm / 60 mm
-40°C ... 85°C
IP20
V0
RJ45
IEC 61643-21/A1 / GB/T 18802.21 / EN 61643-21/A1

### Ordering data

Type	Order No.	Pcs. / Pkt.
D-LAN-CAT.5-FP	2800723	1

ERC

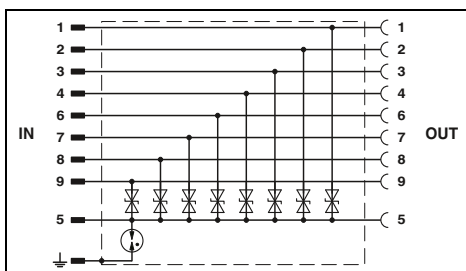

### Technical data

B2 / C1 / C2 / C3
- / -
≤ 1 A (25°C)
≤ 250 A / ≤ 250 A
5 kA
≤ 55 V (C1 - 250 A) / ≤ 450 V (C1 - 250 A)
≤ 50 V / -
typ. 2.5 MHz
25 mm / 108 mm / 63 mm
-40°C ... 85°C
IP20
-
D-SUB-9
DIN EN 61643-21 / IEC 61643-21

### Ordering data

Type	Order No.	Pcs. / Pkt.
DT-UFB-V24/S-9-SB	2803069	1

ERC

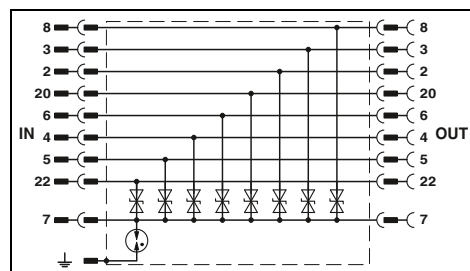

### Technical data

B2 / C1 / C2 / C3
- / -
≤ 1 A (25°C)
≤ 250 A / ≤ 250 A
5 kA
≤ 55 V (C1 - 250 A) / ≤ 450 V (C1 - 250 A)
≤ 50 V / -
typ. 2.5 MHz
25 mm / 110 mm / 63 mm
-40°C ... 85°C
IP20
-
D-SUB-25
DIN EN 61643-21 / IEC 61643-21

### Ordering data

Type	Order No.	Pcs. / Pkt.
DT-UFB-V24/S-SB-SET	2803072	1

# Surge protection and interference suppression filters

## Surge protection for information technology and telecommunications

### For RS-485 or INTERBUS remote bus



For RS-485 interfaces with D-SUB 9 connection

#### DATATRAB DT-UFB-485

- Adapter type
- 9-pos. D-SUB connection
- Can be installed in a control cabinet by removing a ground connection adapter

#### Pin assignment DT-UFB-485:

- 3,8 Data line pair 1 T(A)/T(B)
- 4,9 Data line pair 2 R(A)/R(B)
- 2,7 Signal ground (ground)
- $\perp$   $\perp$

#### DATATRABDT-UFB-IB-RBI/ -RBO

- Adapter type
- 9-pos. D-SUB connection
- For remote bus modules
- Can be installed in a control cabinet by removing a ground connection adapter
- D-SUB cable included

ERC

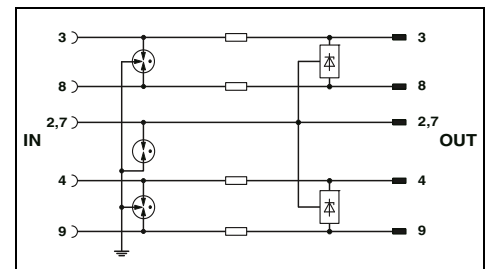

#### Technical data

Electrical data		Technical data	
IEC test classification/EN type		B2 / C1 / C2 / C3 / D1	
Maximum continuous operating voltage $U_c$		12 V DC / -	
Nominal current $I_n$		$\leq 380$ mA (25°C)	
Nominal discharge current $I_n$ (8/20) $\mu$ s			
Total surge current (8/20) $\mu$ s		Core-Core / Core-Ground	$\leq 5$ kA / $\leq 5$ kA
Protection level $U_p$			10 kA
		Core-Core / Core-Ground	$\leq 30$ V (C1 - 500 A) / $\leq 700$ V (C1 - 500 A)
Cut-off frequency $f_g$ (3 dB)		typ. 50 MHz	
In a 100 $\Omega$ system		Symmetrical	-
In a 150 $\Omega$ system		Symmetrical	-
General data		Ordering data	
Dimensions W / H / D		25 mm / 108 mm / 63 mm	
Temperature range		-40°C ... 85°C	
Degree of protection in acc. with IEC 60529/EN 60529		IP20	
Inflammability class in acc. with UL 94		-	
Connection method		D-SUB-9	
Test standards		DIN EN 61643-21	

Description		Ordering data	
DATATRAB adapter, protective adapter to be inserted into the data line		Type	Order No.
		DT-UFB-485/BS	2920612
			Pcs. / Pkt.
			1



For the INTERBUS remote bus input (RBI)



For the INTERBUS remote bus output (RBO)

ERC

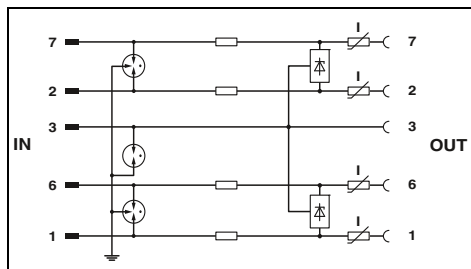

### Technical data

B2 / C1 / C2 / C3 / D1  
5.8 V DC / -  
≤ 180 mA (25°C)

≤ 5 kA / ≤ 5 kA  
10 kA

≤ 20 V (C1 - 500 A) / ≤ 700 V (C1 - 500 A)

≥ 100 MHz  
≥ 100 MHz

25 mm / 110 mm / 63 mm  
-40°C ... 85°C  
IP20

-  
D-SUB-9  
DIN EN 61643-21 / IEC 61643-21

ERC

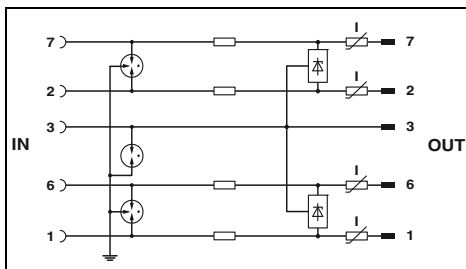

### Technical data

B2 / C1 / C2 / C3 / D1  
5.8 V DC / -  
≤ 180 mA (25°C)

≤ 5 kA / ≤ 5 kA  
10 kA

≤ 20 V (C1 - 500 A) / ≤ 700 V (C1 - 500 A)

≥ 100 MHz  
≥ 100 MHz

25 mm / 110 mm / 63 mm  
-40°C ... 85°C  
IP20

-  
D-SUB-9  
DIN EN 61643-21 / IEC 61643-21

### Ordering data

Type	Order No.	Pcs. / Pkt.
DT-UFB-IB-RBI	2800055	1

### Ordering data

Type	Order No.	Pcs. / Pkt.
DT-UFB-IB-RBO	2800056	1

# Surge protection and interference suppression filters

## Surge protection for information technology and telecommunications

### For PROFIBUS®

- Direct use at the PROFIBUS® interface
- Data transmission speed of up to 12 Mbps
- Integrated termination resistor



PROFIBUS® fine protection with D-SUB 9

ERIC®

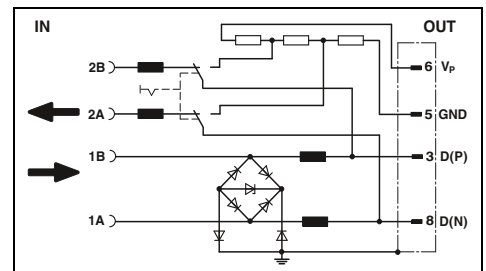

#### Technical data

Electrical data		
IEC test classification/EN type		C1 / C3 / B2
Maximum continuous operating voltage $U_c$		5.2 V DC / -
Nominal current $I_N$		250 mA (25°C)
Nominal discharge current $I_n$ (8/20) $\mu$ s		350 A / 350 A
Total surge current (8/20) $\mu$ s	Core-Core / Core-Ground	350 A
Protection level $U_p$	Core-Core / Core-Ground	$\leq 25$ V (C1 (500 V/250 A)) / $\leq 25$ V (C1 (500 V/250 A))
Output voltage limitation at 1 kV/ $\mu$ s	Core-Core / Core-Ground	$\leq 14$ V / $\leq 14$ V
Cut-off frequency $f_g$ (3 dB)		typ. 70 MHz
In a 100 $\Omega$ system	Symmetrical	
General data		
Dimensions W / H / D		44.5 mm / 58 mm / 16.6 mm
Temperature range		-20°C ... 75°C
Degree of protection in acc. with IEC 60529/EN 60529		IP40
Connection method		Screw connection & D-SUB-9
Test standards		IEC 61643-21

#### Ordering data

Description	Nominal voltage $U_N$	Type	Order No.	Pcs. / Pkt.
<b>DATATRAB</b> , protective device for PROFIBUS® DP applications with up to 12 Mbps		<b>D-UFB-PB</b>	<b>2880642</b>	1



### For Ethernet/PROFINET® networks

- 19" rack for installation in storey distributors
- Up to 24 ports with RJ45 connection
- Reliable transmission speeds up to 1 Gbps
- Protection of all eight signal wires of the data cable
- Indirect grounding via a gas-filled surge arrester in the housing
- Direct grounding via a connection on the housing



**For data interfaces, with RJ45 connection  
Class D/CAT5e**

ERIC

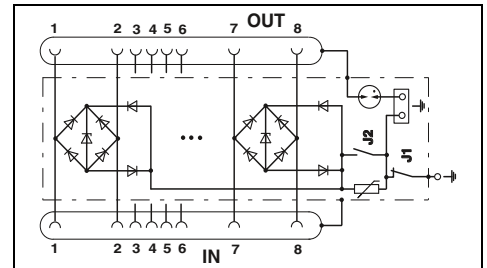

#### Technical data

<b>Electrical data</b>		C1 / C2 / C3 / B3
IEC test classification/EN type		6 V DC
Maximum continuous operating voltage $U_C$		1.5 A (25°C)
Nominal current $I_N$		
Nominal discharge current $I_n$ (8/20) $\mu$ s	Core-Core / Core-Ground	350 A / 350 A
Total surge current (8/20) $\mu$ s		10 kA
Protection level $U_p$	Core-Core / Core-Ground	$\leq 50$ V (C1, 500 V/250 A) / $\leq 40$ V (C1, 500 V/250 A (J2 ON))
Output voltage limitation at 1 kV/ $\mu$ s	Core-Core / Core-Ground	$\leq 20$ V / $\leq 30$ V (J2 inserted)
Cut-off frequency fg (3 dB)		
In a 100 $\Omega$ system	Symmetrical	> 100 MHz
<b>General data</b>		
Dimensions W / H / D		483 mm / 44 mm / 160 mm
Temperature range		-40°C ... 80°C
Degree of protection in acc. with IEC 60529/EN 60529		IP20
Connection method		RJ45
Test standards		IEC 61643-21

#### Ordering data

Description	Type	Order No.	Pcs. / Pkt.	
<b>DATATRAB</b> , for use in Ethernet, token ring, FDDI/CDDI according to Cat. D/CAT5 EN 50173 (1000Base-T)	24 ports	<b>D-LAN-19"-24</b>	2838791	1
	20 ports	<b>D-LAN-19"-20</b>	2880134	1
	16 ports	<b>D-LAN-19"-16</b>	2880147	1
	12 ports	<b>D-LAN-19"-12</b>	2880150	1
	8 ports	<b>D-LAN-19"-8</b>	2880163	1
	4 ports	<b>D-LAN-19"-4</b>	2880176	1
<b>Surge protection PCB</b> as replacement or for retrofitting in D-LAN-19".... products, incl. RJ45 sockets				
4 ports	<b>D-LAN-19"-D-P</b>	2880192		1

# Surge protection and interference suppression filters

## Surge protection for information technology and telecommunications

### For telecommunications interfaces

- Protection for two DSL ports
- Connection: RJ45 (RJ12/RJ11) and plug-in screw terminal block (COMBICON)
- Alternatively, can be snapped onto a DIN rail
- Protective circuit:  
Course/fine protection combination between all cables of signal wire pairs, as well as common mode voltage coarse protection between all signal wires and ground
- Separate ground connection line
- The adapter included enables conversion from RJ45 to RJ11 and RJ12 (for contacting, see circuit diagram)



Attachment plug for two VDSL interfaces (ports)



Attachment plug for two SHDSL interfaces (ports)

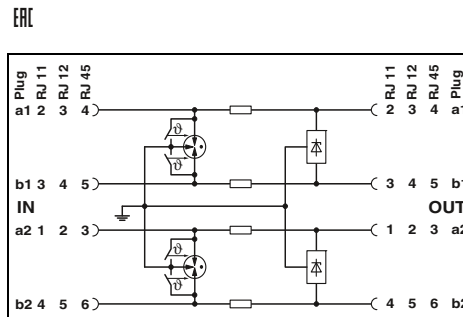

#### Technical data

Electrical data		
IEC test classification/EN type		B2 / C1 / C2 / C3 / D1
Maximum continuous operating voltage $U_C$		185 V DC
Nominal current $I_N$		$\leq 380$ mA (25°C)
Nominal discharge current $I_n$ (8/20) $\mu$ s	Core-Core / Core-Ground	$\leq 5$ kA / $\leq 5$ kA
Total surge current (8/20) $\mu$ s		10 kA
Protection level $U_p$	Core-Core / Core-Ground	- / -
Cut-off frequency $f_g$ (3 dB)		typ. 50 MHz
In a 100 $\Omega$ system	Core-Core	
General data		
Dimensions W / H / D		25 mm / 103 mm / 63 mm
Connection data solid / stranded / AWG		0.14 ... 1.5 mm <sup>2</sup> / 0.14 ... 1.5 mm <sup>2</sup> / 28 - 16
Temperature range		-40°C ... 85°C
Degree of protection in acc. with IEC 60529/EN 60529		IP20
Connection method		RJ45/COMBICON
Test standards		IEC 61643-21

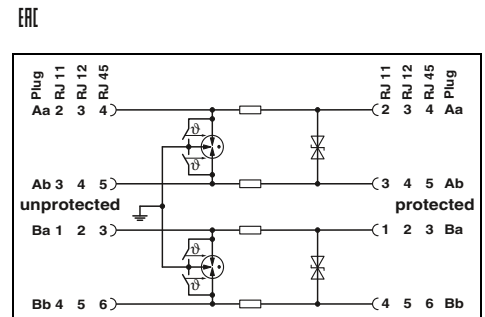

#### Technical data

Electrical data		
IEC test classification/EN type		B2 / C1 / C2 / C3 / D1
Maximum continuous operating voltage $U_C$		185 V DC
Nominal current $I_N$		$\leq 380$ mA (25°C)
Nominal discharge current $I_n$ (8/20) $\mu$ s	Core-Core / Core-Ground	$\leq 5$ kA / $\leq 5$ kA
Total surge current (8/20) $\mu$ s		10 kA
Protection level $U_p$	Core-Core / Core-Ground	$\leq 250$ V (C1 - 500 A) / $\leq 580$ V (C1 - 500 A)
Cut-off frequency $f_g$ (3 dB)		25 MHz
In a 100 $\Omega$ system	Core-Core	
General data		
Dimensions W / H / D		25 mm / 103 mm / 63 mm
Connection data solid / stranded / AWG		0.14 ... 1.5 mm <sup>2</sup> / 0.14 ... 1.5 mm <sup>2</sup> / 28 - 16
Temperature range		-40°C ... 85°C
Degree of protection in acc. with IEC 60529/EN 60529		IP20
Connection method		RJ45/COMBICON
Test standards		IEC 61643-21

#### Ordering data

Description	Voltage $U_N$	Type	Order No.	Pcs. / Pkt.
DATATRAB, protective adapter for insertion in the data cable		DT-TELE-RJ45	2882925	1

#### Ordering data

Description	Voltage $U_N$	Type	Order No.	Pcs. / Pkt.
DATATRAB, protective adapter for insertion in the data cable		DT-TELE-SHDSL	2801593	1

**For analog and DSL telecommunications systems**

- For surface mounting
- Three TAE6 slots
- For two N-coded and one F-coded end device
- Suitable for ADSL and VDSL
- Main areas of application: phone terminals, answering machines, modems, and fax machines



**TAE outlet box for VDSL (NFN)**

ERIC

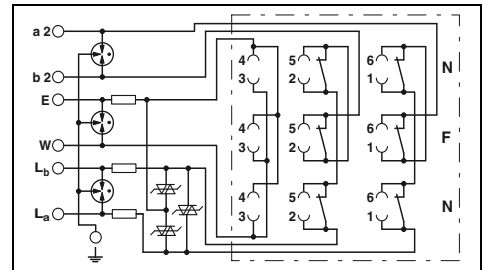

**Technical data**

Electrical data		
IEC test classification/EN type		B2 / C1 / C2 / C3 / D1
Nominal voltage $U_N$		60 V DC
Maximum continuous operating voltage $U_C$		185 V DC
Nominal current $I_N$		450 mA ( $\leq 40^\circ\text{C}$ )
Nominal discharge current $I_n$ (8/20) $\mu\text{s}$		
Total surge current (8/20) $\mu\text{s}$	Core-Core / Core-Ground	5 kA / 5 kA
Protection level $U_p$		10 kA
	Core-Core / Core-Ground	$\leq 250\text{ V}$ (C2 - 10 kV / 5 kA) / $\leq 500\text{ V}$ (C2 - 10 kV / 5 kA)
Output voltage limitation at 1 kV/ $\mu\text{s}$		
	Core-Core / Core-Ground	$\leq 250\text{ V} / \leq 450\text{ V}$
Cut-off frequency $f_g$ (3 dB)		
In a 600 $\Omega$ system	Core-Core	typ. 2 MHz
General data		
Dimensions W / H / D		65 mm / 27 mm / 80 mm
Temperature range		$-40^\circ\text{C} \dots 80^\circ\text{C}$
Degree of protection in acc. with IEC 60529/EN 60529		IP20
Connection method		Screw connection & TAE 6
Test standards		DIN EN 61643-21 / IEC 61643-21

**Ordering data**

Description	Type	Order No.	Pcs. / Pkt.
<b>TAE outlet box (NFN)</b> with surge protection for analog telecommunications interfaces			
Surface-mounted socket	D TAE-TRAB FM-NFN-AP	2749628	1

# Surge protection and interference suppression filters

## Surge protection for information technology and telecommunications

### For telecommunications and measurement and control interfaces COMTRAB modular

- Space-saving LSA-PLUS connection technology
- Can be used in LSA-PLUS disconnect and control strips or CT-TERMIBLOCK
- The CTM 10-MAG surge protection magazine can be fitted with ten different protective plugs



Double wire (loop), floating



2-wire, with common reference potential

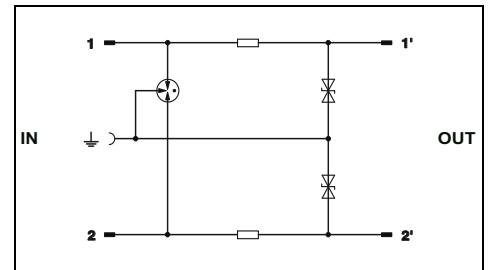
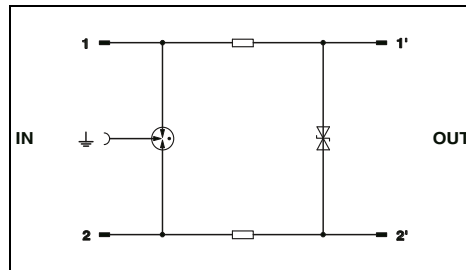

#### Technical data

Electrical data	... 12DC	... 24DC	... 60DC	... 110AC
IEC test classification/EN type	B2 / C1 / C2 / C3 / D1	B2 / C1 / C2 / C3 / D1	B2 / C1 / C2 / C3 / D1	B2 / C1 / C2 / C3 / D1
Maximum continuous operating voltage $U_c$	± 15 V DC / 10 V AC	± 30 V DC / 21 V AC	± 65 V DC / 50 V AC	± 180 V DC / 125 V AC
Impulse discharge curr. $I_{mp}$ (10/350) $\mu$ s	1 kA	1 kA	1 kA	1 kA
Nominal current $I_N$	380 mA (25°C)	380 mA (25°C)	380 mA (25°C)	380 mA (25°C)
Nominal discharge current $I_n$ (8/20) $\mu$ s				
Total surge current (8/20) $\mu$ s	Core-Core / Core-Ground	5 kA / 5 kA	5 kA / 5 kA	5 kA / 5 kA
	Core-Ground	10 kA	10 kA	10 kA
Output voltage limitation at 1 kV/ $\mu$ s	Core-Core	≤ 25 V	≤ 70 V	≤ 160 V
	Core-Ground	≤ 700 V	≤ 700 V	≤ 800 V
Cut-off frequency $f_g$ (3 dB)	Symmetrical / asymmetrical in the 100 $\Omega$ system	1.2 MHz / -	2.7 MHz / -	2 MHz / -
		3.3 $\Omega$	3.3 $\Omega$	3.3 $\Omega$
Resistance per path				
General data				
Dimensions W / H / D		9.5 mm / 21 mm / 53.5 mm		
Temperature range		-25°C ... 75°C		
Degree of protection in acc. with IEC 60529/EN 60529		IP20		
Inflammability class in acc. with UL 94		V0		
Test standards		IEC 61643-21		

#### Technical data

Electrical data	... 12DC	... 24DC	... 60DC	... 110AC
IEC test classification/EN type	B2 / C1 / C2 / C3 / D1	B2 / C1 / C2 / C3 / D1	B2 / C1 / C2 / C3 / D1	B2 / C1 / C2 / C3 / D1
Maximum continuous operating voltage $U_c$	± 15 V DC / 10 V AC	± 30 V DC / 21 V AC	± 65 V DC / 50 V AC	± 180 V DC / 125 V AC
Impulse discharge curr. $I_{mp}$ (10/350) $\mu$ s	1 kA	1 kA	1 kA	1 kA
Nominal current $I_N$	380 mA (25°C)	380 mA (25°C)	380 mA (25°C)	380 mA (25°C)
Nominal discharge current $I_n$ (8/20) $\mu$ s				
Total surge current (8/20) $\mu$ s	Core-Core / Core-Ground	- / 5 kA	- / 5 kA	- / 5 kA
	Core-Ground	10 kA	10 kA	10 kA
Output voltage limitation at 1 kV/ $\mu$ s	Core-Core	-	-	-
	Core-Ground	≤ 22 V	≤ 45 V	≤ 160 V
Cut-off frequency $f_g$ (3 dB)	Symmetrical / asymmetrical in the 100 $\Omega$ system	- / 1.5 MHz	- / 2.7 MHz	- / 2 MHz
		3.3 $\Omega$	3.3 $\Omega$	3.3 $\Omega$
Resistance per path				
General data				
Dimensions W / H / D		9.5 mm / 21 mm / 53.5 mm		
Temperature range		-25°C ... 75°C		
Degree of protection in acc. with IEC 60529/EN 60529		IP20		
Inflammability class in acc. with UL 94		V0		
Test standards		IEC 61643-21		

#### Ordering data

Description	Voltage $U_N$	Type	Order No.	Pcs. / Pkt.
<b>COMTRAB modular</b>	12 V DC	CTM 1X2- 12DC	2838597	10
	24 V DC	CTM 1X2- 24DC	2838513	10
	60 V DC	CTM 1X2- 60DC	2838568	10
	110 V AC	CTM 1X2-110AC	2838539	10
	180 V DC			
<b>COMTRAB modular, surge protection for the ISDN-S<sub>0</sub> interface</b>				
	6 V DC			

#### Ordering data

Type	Order No.	Pcs. / Pkt.
CTM 2X1- 12DC	2838584	10
CTM 2X1- 24DC	2838500	10
CTM 2X1- 60DC	2838542	10
CTM 2X1-110AC	2838526	10

#### Accessories

Accessories	Order No.	Pcs. / Pkt.
CTM 10-MAG	2838610	5
CTM EST	2838649	10

#### Accessories

Accessories	Order No.	Pcs. / Pkt.
CTM 10-MAG	2838610	5
CTM EST	2838649	10



2-wire, with common reference potential



2-wire, coarse protection, with failsafe contact



2-wire, coarse protection, with failsafe contact and current protection (Powercross)

ERIC

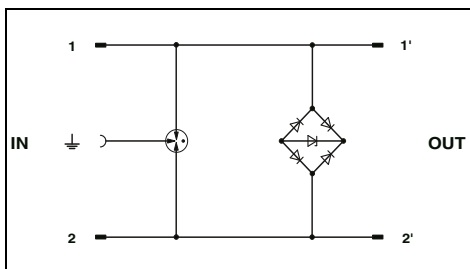

### Technical data

B2 / C2 / C3 / D1 / C1

± 6 V DC / -

1 kA  
1.5 A (25°C)

350 A / 5 kA  
10 kA

≤ 15 V  
≤ 700 V

≥ 100 MHz / -

9.5 mm / 21 mm / 53.5 mm

-25°C ... 75°C

IP20

V0

IEC 61643-21

### Ordering data

Type	Order No.	Pcs. / Pkt.
CTM ISDN	2838555	10

### Accessories

CTM 10-MAG	2838610	5
CTM EST	2838649	10

ERIC

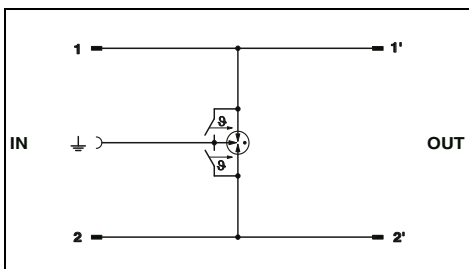

### Technical data

A2 / B1 / B2 / B3 / C1 / C2 / C3 / D1 / D2

± 180 V DC / -

1 kA  
1.5 A (25°C)

- / 5 kA  
10 kA

-  
≤ 800 V

- / > 100 MHz

9.5 mm / 21 mm / 53.5 mm

-40°C ... 85°C

IP20

V0

IEC 61643-21

### Ordering data

Type	Order No.	Pcs. / Pkt.
CTM 2X1-180DC-GS	2838636	10

### Accessories

CTM 10-MAG	2838610	5
CTM EST	2838649	10

ERIC

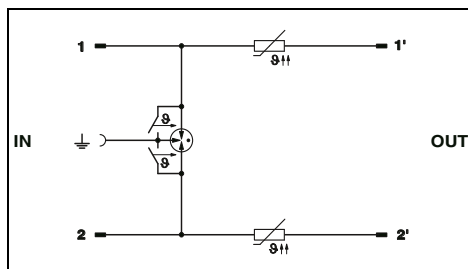

### Technical data

A2 / B1 / B2 / B3 / C1 / C2 / C3 / D1 / D2

± 180 V DC / -

1 kA  
120 mA (25°C)

- / 5 kA  
10 kA

-  
≤ 800 V

- / > 100 MHz  
5.5 Ω

9.5 mm / 21 mm / 53.5 mm

-40°C ... 85°C

IP20

V0

IEC 61643-21

### Ordering data

Type	Order No.	Pcs. / Pkt.
CTM 2X1-180DC-GS-P	2838623	10

### Accessories

CTM 10-MAG	2838610	5
CTM EST	2838649	10

# Surge protection and interference suppression filters

## Surge protection for information technology and telecommunications

### LSA-PLUS coarse protection magazine

- For use in CT-TERMIBLOCK or in LSA-PLUS and LSA-PROFIL disconnect and terminal strips

#### CT 10-2/2-GS

- For fitting with 20 two-electrode arresters filled with inert gas
- Common mode voltage coarse protection for 20 signal wires

#### CT ...-2/2-GS/3E

- Fitted with up to 10 three-electrode arresters filled with inert gas
- When the gas-filled arrester is triggered, the potentials of the three connections a-b- $\perp$  are equalized
- Coarse protection both in the normal mode voltage branch and the common mode voltage branch for 10 double wires

#### Notes:

For dimensional drawings, see phoenixcontact.net/products



For 10 double wires (loops) and 20 two-electrode gas-filled surge arresters



For 10 double wires (loops) and 10 three-electrode gas-filled surge arresters

ERC

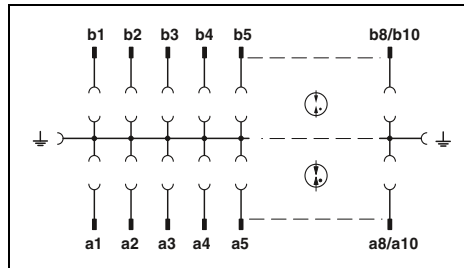

ERC

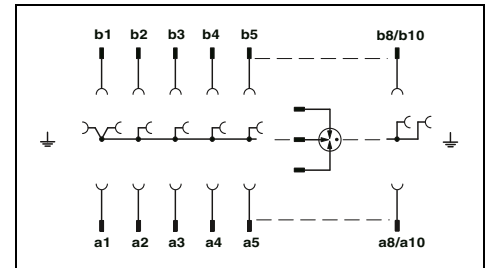

#### Ordering data

Type	Order No.	Pcs. / Pkt.
CT 10-2/2-GS	2765398	5

#### Ordering data

Type	Order No.	Pcs. / Pkt.
CT 10-2/2-GS/3E	2765408	5
CT 10-2/2-GS/3E-110AC	2920829	10

#### Accessories

Type	Order No.	Pcs. / Pkt.
SVP 2E- 48AC	2788919	10
SVP 2E-110AC	2765534	10

#### Accessories

Type	Order No.	Pcs. / Pkt.
SVP 3E-110AC	2765521	10

Description	Voltage U <sub>N</sub>
Coarse protection magazine, to accommodate 20 two-electrode gas-filled surge arresters, type H, unassembled, version: 10 double wires	
Coarse protection card cage, for 10 double wires unassembled, for accommodating 10 three-electrode gas-filled surge arresters	
assembled, with 10 three-electrode gas-filled surge arresters	110 V AC
2-electrode gas-filled surge arrester filled with inert gas, type H, for use in CT 10-2/2-GS coarse protection magazine	48 V AC 110 V AC
3-electrode gas-filled surge arrester filled with inert gas, for use in CT 10-2/2-GS/3E coarse protection magazine	110 V AC

### CT-TERMIBLOCK

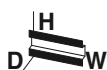

- Screw terminal block
- For COMTRAB protective plugs
- Automatically closing feed-through/disconnect contacts
- Ground terminal blocks on both sides with plug-in connection for the protective plugs used
- Mounting on DIN rails according to EN 60715



For accommodating the CT and CTM protective plugs, with screw connection



Magazine for 10 CTM

**Notes:**  
For dimensional drawings, see [phoenixcontact.net/products](http://phoenixcontact.net/products)

General data
Dimensions W / H / D
Connection data solid / stranded / AWG
Temperature range
Degree of protection in acc. with IEC 60529/EN 60529
Inflammability class in acc. with UL 94

#### Technical data

118 mm / 43 mm / 40.9 mm
0.2 ... 2.5 mm <sup>2</sup> / 0.2 ... 2.5 mm <sup>2</sup> / 24 - 14
-40°C ... 85°C
IP20
V2

#### Technical data

112.5 mm / 21.8 mm / 44 mm
- / - / -
-25°C ... 75°C
IP20
V0

#### Description

**Screw termination block** with disconnect contacts for accommodating CT and CTM protective plugs, version: 10 double wires

**Magazine**, with a grounding rail to accommodate up to 10 LSA-PLUS protective plugs (CTM...), to insert in CT-TERMIBLOCK or LSA-PLUS disconnect strip

#### Ordering data

Type	Order No.	Pcs. / Pkt.
CT-TERMIBLOCK 10 DA	0441711	10

#### Ordering data

Type	Order No.	Pcs. / Pkt.
CTM 10-MAG	2838610	5

### COMTRAB disconnect strip

- LSA-PLUS disconnect strip
- For COMTRAB protective plugs
- For up to 10 CTM plugs

**Notes:**  
For dimensional drawings, see [phoenixcontact.net/products](http://phoenixcontact.net/products)

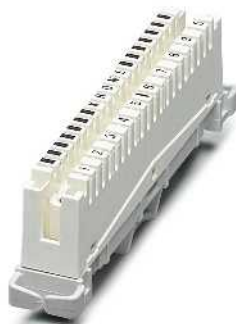

For accommodating the CT and CTM protective plugs, with LSA-PLUS connection



Grounding rail/mounting clip

#### Description

**LSA-PLUS disconnect strip** to hold the CTM and CT 10 protection modules, version: 10 double wires

**Grounding rail** for CTM protective plug when used in combination with LSA-PLUS disconnect strip, version: 10 double wires

**Mounting clip**, for holding 3 disconnect or ground wire strips, version: 10 double wires

**Mounting clip**, for holding 10 disconnect or ground wire strips, version: 10 double wires

**Cable feed-through sleeve** for assembly troughs, for protection of the lines guided through the laminated frame

#### Ordering data

Type	Order No.	Pcs. / Pkt.
CT 10-TL	2765356	5

#### Ordering data

Type	Order No.	Pcs. / Pkt.
CT 1-10-ES	2765547	10
CT 10-MB/3	2765372	2
CT 10-MB/10	2765385	2
CT-KDT	2765518	10

# Surge protection and interference suppression filters

## Surge protection for information technology and telecommunications

### Protection of PROFIBUS DP

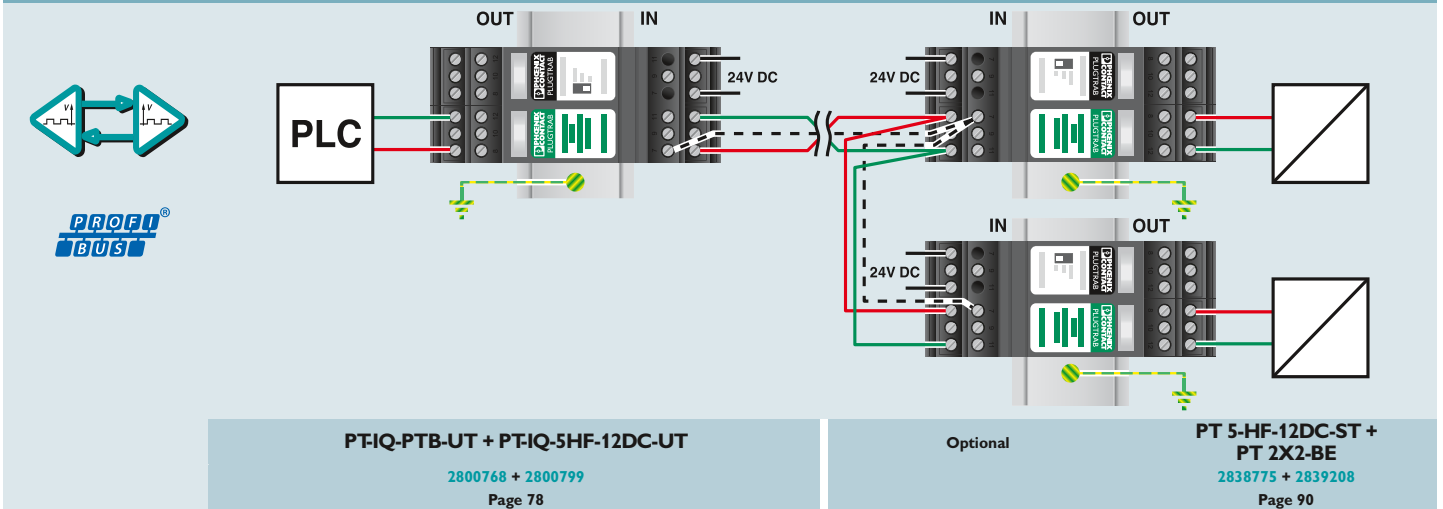

### Protection of PROFIBUS PA

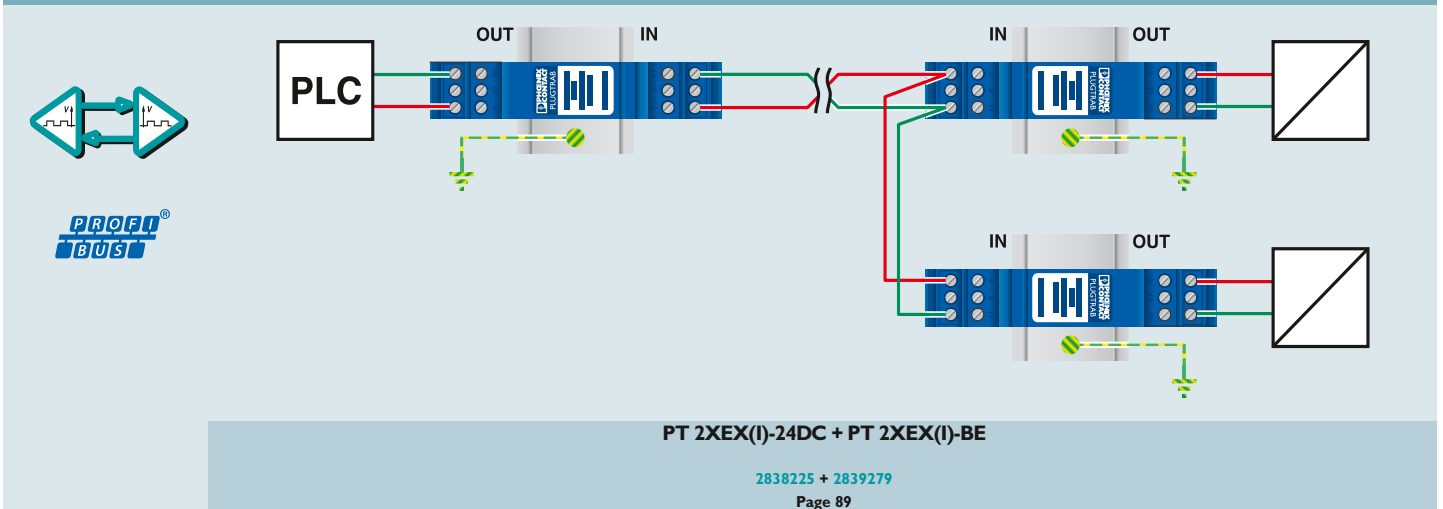

### Protection of CAN bus/DeviceNet™

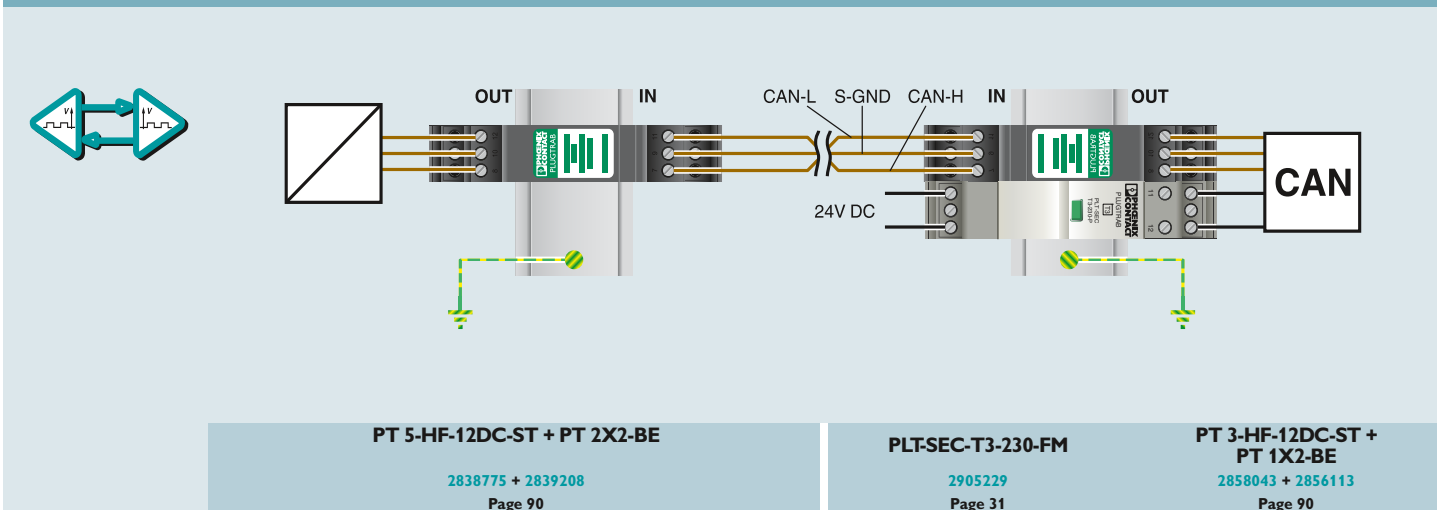



### Protection of an RS-485 interface

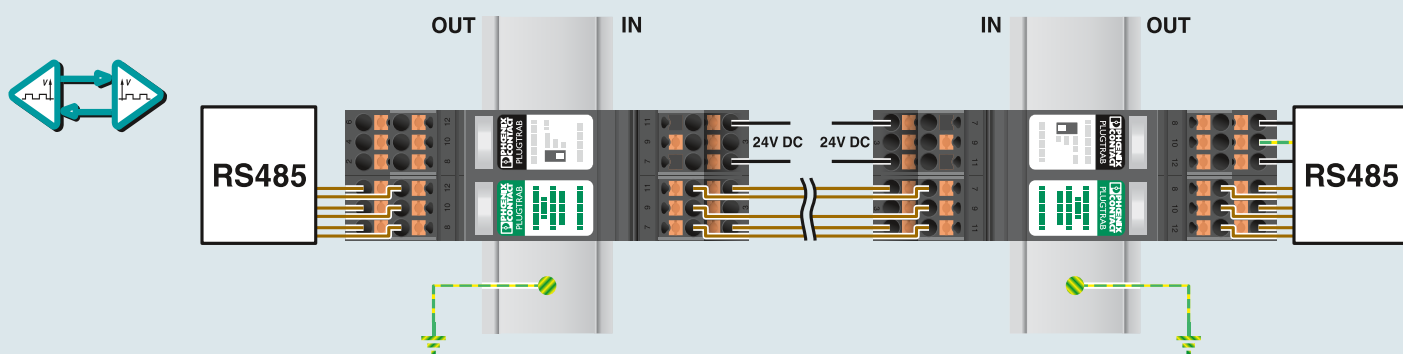

**PT-IQ-PTB-PT + PT-IQ-5-HF-12DC-PT**

2801296 + 2801293

Page 78

Optional

**PT 5-HF-12DC-ST + PT 2X2+F-BE**

2838775 + 2839224

Page 90

### Protection of an Ethernet interface (including PoE)

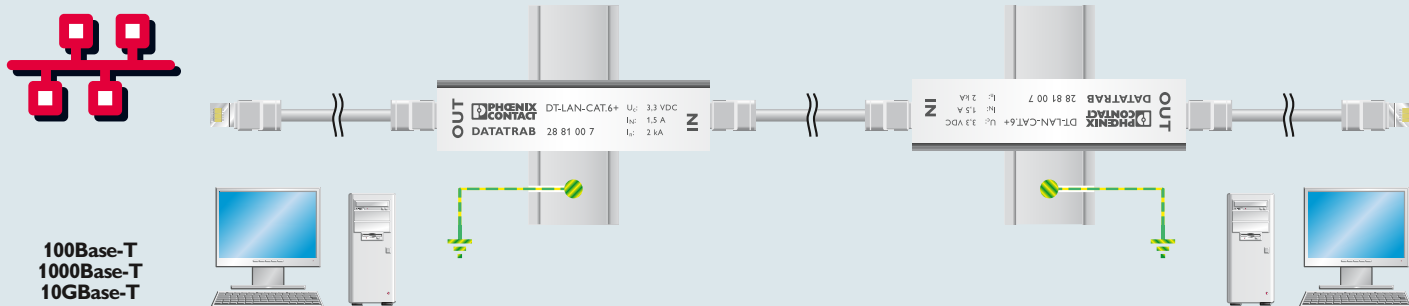

100Base-T  
1000Base-T  
10GBase-T

**DTLAN-CAT.6+**

2881007

Page 108

### Protection of a DSL interface

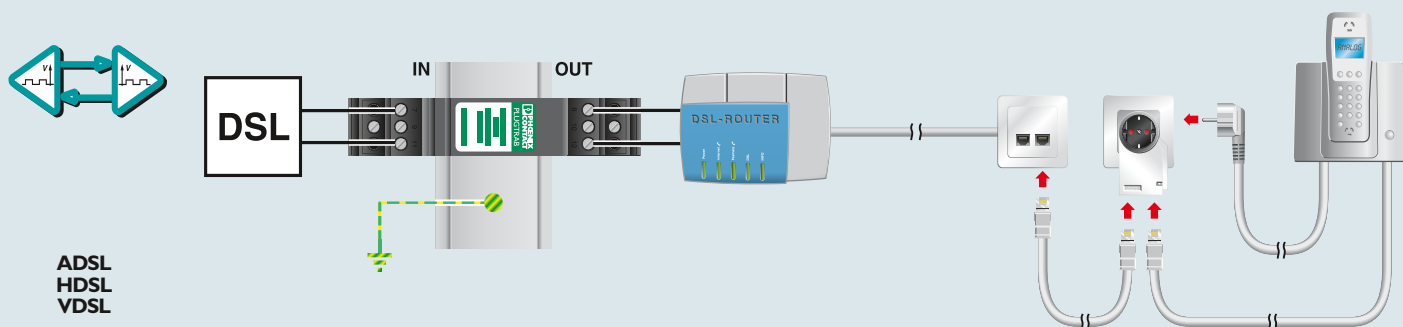

ADSL  
HDSL  
VDSL

**PT 2-TELE**

2882828

Page 91

**MNT-TAE D/WH**

2882394

Page 57



### You won't lose reception with COAXTRAB

Transceiver systems are generally considered to be particularly susceptible to surge voltages. Antenna cables which extend beyond a building and are usually very long, plus the antennas themselves, are directly exposed to atmospherical discharge.

Cables with a coaxial structure and therefore favorable EMC properties are primarily used in antenna systems. However, the risk of surge voltage coupling in antenna cables and potential transfer through to the sensitive interfaces of transceiver systems is not eliminated.

Thanks to interface-optimized surge protective devices, the COAXTRAB product range significantly increases safety for transceiver equipment. The aim of such safety measures is to increase the availability and operability of the devices affected.

**i** Your web code: [#0146](#)

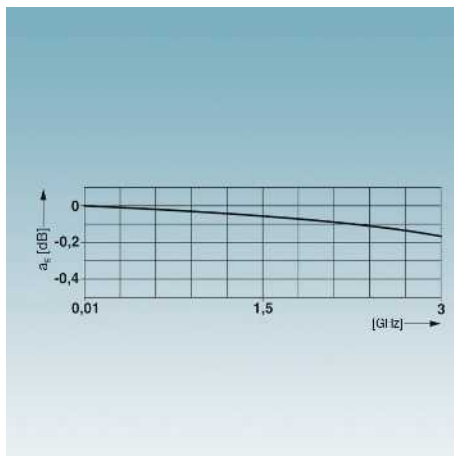

### Shielding

Good shielding properties are vital for a clean transmission. The robust metal housings provide ideal shielding properties and are also suitable for use in harsh industrial environments.

### Customized products

Appropriate protective devices are available for all applications including SAT receiver systems, mobile phones, and video monitoring.

The very low attenuation values ensure that data transmission is clean.

### Performance classes

The protective devices conform to standards in all performance classes. This applies for coarse protection in accordance with Category D1, 10/350  $\mu$ s and for fine protection in accordance with Category C2 and C1, 8/20  $\mu$ s.



### Connection technology

The right connection technology to suit the application: F connector, TV connector, type N, 7/16, UHF, BNC, SMA.

# Surge protection and interference suppression filters

## Surge protection for transceiver systems







The interface matrix indicates which surge protective device is suitable for a specific transceiver system.

### Note:

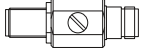
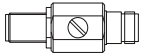
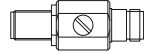
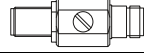
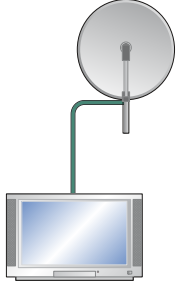
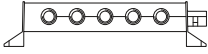
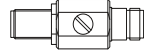
For further interface recommendations, visit [phoenixcontact.net/products](http://phoenixcontact.net/products)

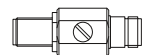
1) The PT-IQ-PTB-UT supply module is required in order to operate the PT-IQ series.

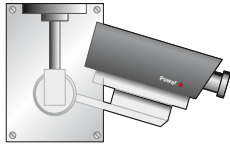
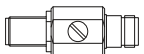
Explanation of the IEC categories		
LPZ	Test category for SPD corresponds to IEC 61643-21	Test class for SPD corresponds to IEC 61643-11
0/1	D1	I
1/2	C2	II
2/3	C1	III

Technology	Interface	Mounting
	GPS, GSM, UMTS, LTE (900, 1800, 1900 MHz)	
	GSM, UMTS, LTE (without COAX DC supply) (900, 1800, 1900 MHz)	
	WiMAX, LTE (2.4 ... 6 GHz)	
	GSM, Industrial wireless (2.4 GHz)	
	Satellite television (upstream of the antenna distributor)	
	Satellite television (upstream of the SAT receiver or TV)	 
	Cable/terrestrial TV	
		
	Video monitoring (Coax connection)	
	Video monitoring (2-wire connection)	

Connection technology	IEC category	Protected wires	Arrester	Order No.	Page
Coax type N	D1/C2/C3	2	CN-UB-280DC-3	<a href="#">2801050 / 2801051</a>	126
	D1/C2/C3	2	CN-UB-70-6	<a href="#">2803166 / 2803153</a>	126
Coax type N	D1/C2/C3	2	CN-LAMBDA/4-2.25	<a href="#">2801057 / 2801056</a>	128
Coax 7/16	D1/C2/C3	2	C7/16-LAMBDA/4-2.25	<a href="#">2801060 / 2801059</a>	129
Coax type N	D1/C2/C3	2	CN-LAMBDA/4-5.9	<a href="#">2838490 / 2800023</a>	129
Coax SMA	D1/C2/C3	2	CSMA-LAMBDA/4-2.0-BS-SET	<a href="#">2800491</a>	129
Coax F	D1/C2/C1	5 x 2	C-SAT-BOX	<a href="#">2880561</a>	130
Coax F	D1/C2/C1	2	C-TV-SAT	<a href="#">2856993</a>	131
Coax F and IEC	D1/C2/C3 & T3	2	MNT-TV-SAT	<a href="#">2882297</a>	57
Coax IEC	D1/C2/C1	2	C-TV/HIFI	<a href="#">2857002</a>	131
Coax F and IEC	D1/C2/C3 & T3	2	MNT-TV-SAT	<a href="#">2882297</a>	57
Coax BNC	D1/C2/C3	2	C-UFB-5DC/E	<a href="#">2782300</a>	127
	D1/C2/C3	2	C-UFB-5DC/E 75	<a href="#">2763604</a>	127
Terminal block	D1/C2/C1	2	PT-IQ-3-PB+F-UT	<a href="#">2800994</a>	78
	D1/C2/C1	2 x 2	PT-IQ-2X2-5DC-UT	<a href="#">2800807</a>	76

# Surge protection and interference suppression filters

## Surge protection for transceiver systems

### For GSM, TETRA, and video systems

- For antennas with N and BNC connection
- High transmission capacities even for frequencies up to 6 GHz
- Mounting plate enables fixed mounting, e.g., in a control cabinet
- The protective adapters can also be used in a 75 Ω system with 50 Ω BNC connectors
- For the CN-UB-280DC, the gas-filled surge arrester can be replaced in case of malfunction



For GSM systems (0 - 3 GHz), grounded shield, connection: N type



For GSM systems (0 - 6 GHz), grounded shield, connection: type N

**Notes:**  
Attenuation characteristics at phoenixcontact.net/products

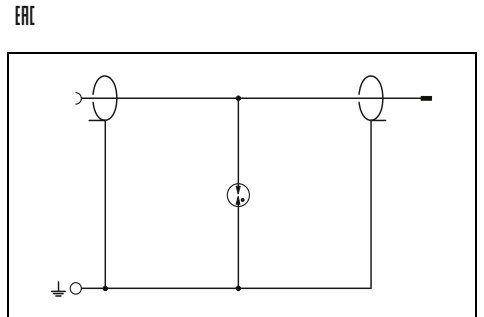
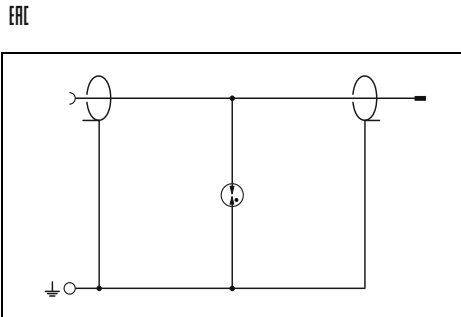

Electrical data	
IEC test classification/EN type	
Maximum continuous operating voltage $U_C$	
Nominal current $I_N$	
Nominal discharge current $I_n$ (8/20) $\mu$ s	
Total surge current (8/20) $\mu$ s	Core-Shield / Core-Ground
Protection level $U_p$	Core-Shield / Core-Ground
In a 50 Ω system	Asymmetrical
Standing wave ratio SWR in a 50 Ω system	> 3 GHz
Permissible RF power $P_{max}$	typ. 1.15 ( $\leq$ 3 GHz) 700 W (VSWR = 1.1)
General data	
Dimensions W / H / D	
Temperature range	
Degree of protection in acc. with IEC 60529/EN 60529	
Connection method	
Test standards	

Technical data		
C2 / C3 / D1	280 V DC	5 A (25°C)
Core-Shield / Core-Ground	20 kA / 20 kA	20 kA
Core-Shield / Core-Ground	$\leq$ 900 V (C1 - 1 kV/500 A) / $\leq$ 900 V (C1 - 1 kV/500 A)	
Asymmetrical	> 3 GHz	typ. 1.15 ( $\leq$ 3 GHz)
		700 W (VSWR = 1.1)
	31 mm / 33.5 mm / 57.8 mm	
	-40°C ... 80°C	
	IP55	
	N connector 50 Ω	
	IEC 61643-21/A1 / -	

Technical data		
C2 / C3 / D1	70 V DC / 50 V AC	10 A
Core-Shield / Core-Ground	5 kA / 5 kA	5 kA
Core-Shield / Core-Ground	$\leq$ 800 V (C2 - 4 kV/2 kA) / $\leq$ 800 V (C2 - 4 kV/2 kA)	
	> 6 GHz	typ. 1.15 (6 GHz)
		30 W (VSWR = 1.15)
	24 mm / 50 mm / 24 mm	
	-40°C ... 90°C	
	IP68	
	N connector 50 Ω	
	IEC 61643-21	

Description	
COAXTRAB, protective adapter for antenna connections	
Socket-socket	CN-UB-280DC-3-BB
Connector-socket	CN-UB-280DC-3-SB
COAXTRAB, as surge protection for coaxial cables, connection via connector and socket	
BNC 50 Ω	
BNC 75 Ω	

Ordering data		
Type	Order No.	Pcs. / Pkt.
CN-UB-280DC-3-BB	2801050	1
CN-UB-280DC-3-SB	2801051	1

Ordering data		
Type	Order No.	Pcs. / Pkt.
CN-UB-70DC-6-BB	2803166	1
CN-UB-70DC-6-SB	2803153	1

Mounting plate, for individual attachment to housing panels	
straight	CN-UB/MP
angled	CN-UB/MP-90DEG-50
BNC connector, single-level, for mounting on NS 32 or NS 35/7,5	
50 Ω wave impedance	
75 Ω wave impedance	
Adapter, insertion loss <0.3 dB at 2.4 GHz	
N (male) -> SMA (female)	
Adapter cable, pigtail, 50 Ω impedance; 50 cm long, MCX (male) -> N (male)	

Accessories		
Type	Order No.	Pcs. / Pkt.
CN-UB/MP	2818135	10
CN-UB/MP-90DEG-50	2803137	10

Accessories		
Type	Order No.	Pcs. / Pkt.
CN-UB/MP	2818135	10
CN-UB/MP-90DEG-50	2803137	10
RAD-ADP-N/M-SMA/F	2917036	1
RAD-PIG-EF316-MCX-N	2867681	1



For TETRA systems (380 MHz - 470 MHz), floating shield, connection: type N



For video systems, floating shield, coarse protection, connection: BNC



For video systems, floating shield, connection: BNC

ERC

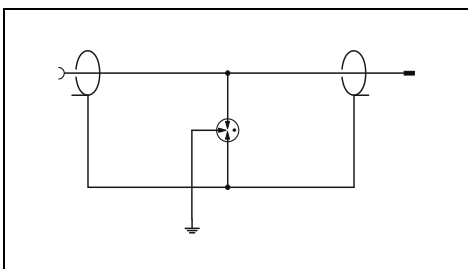

### Technical data

C2 / C3 / D1  
180 V DC / 130 V AC  
5 A (25°C)

5 kA / 5 kA  
10 kA

≤ 700 V (C2 - 10 kV/5 kA) / ≤ 500 V (C2 - 10 kV/5 kA)

typ. 1 GHz  
≤ 1.2 (≤ 200 MHz)  
300 W (VSWR = 1.1)

25.4 mm / 25.4 mm / 83 mm  
-40°C ... 80°C  
IP20  
N connector 50 Ω

ERC

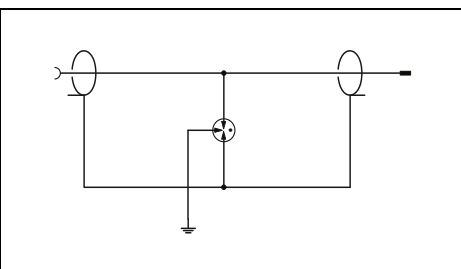

### Technical data

C2 / C3 / D1  
180 V DC / 130 V AC  
3.5 A (25°C)

5 kA / 5 kA  
10 kA

≤ 700 V (C2 - 10 kV / 5 kA) / ≤ 500 V (C2 - 10 kV / 5 kA)

typ. 1 GHz  
typ. 1.3 (≤ 150 MHz)  
300 W (VSWR = 1.1)

25.4 mm / 80 mm / 2.54 mm  
-40°C ... 80°C  
IP20  
BNC 50 Ω  
IEC 61643-21 / -

ERC

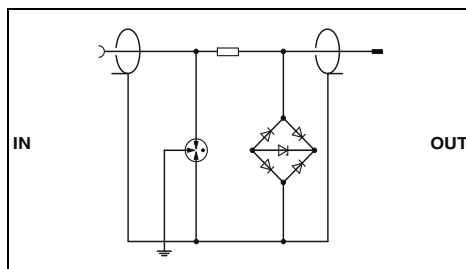

### Technical data

... 5DC/E	... 24DC/E	... 5DC/E 75
C2 / C3 / D1	C2 / C3 / D1	C2 / C3 / D1
5 V DC	30 V DC	-
185 mA (25°C)	185 mA (25°C)	-

10 kA / 10 kA	10 kA / 10 kA	10 kA / 10 kA
20 kA	20 kA	20 kA

≤ 55 V (C1 - 1 kV/500 A) / ≤ 500 V (C1 - 1 kV/500 A)	≤ 70 V (C1 - 1 kV/500 A) / -	≤ 55 V (C1 - 1 kV/500 A) / -
typ. 90 MHz	typ. 90 MHz	typ. 80 MHz

BNC 50 Ω	BNC 50 Ω	BNC 75 Ω
		IEC 61643-21

### Ordering data

Type	Order No.	Pcs. / Pkt.
CN-UB/E-BB	2817686	1
CN-UB/E	2763691	1

### Ordering data

Type	Order No.	Pcs. / Pkt.
C-UB/E	2763701	10

### Ordering data

Type	Order No.	Pcs. / Pkt.
C-UFB-24DC/E	2782313	10
C-UFB-5DC/E 75	2763604	10

### Accessories

Type	Order No.	Pcs. / Pkt.
BNC-V 50	2805041	10

### Accessories

Type	Order No.	Pcs. / Pkt.
BNC-V 50	2805041	10

### Accessories

Type	Order No.	Pcs. / Pkt.
BNC-V 50	2805041	10
BNC-V 75	2805070	10

# Surge protection and interference suppression filters

## Surge protection for transceiver systems

### With Lambda/4 technology for TETRA, GSM, and WiMAX systems

- For antennas with N, 7/16, and SMA connection
- High transmission capacities even for frequencies up to 6 GHz
- Maintenance-free surge protection with Lambda/4 technology
- Low protection level

**Notes:**  
Attenuation characteristics at phoenixcontact.net/products



For TETRA systems (380 MHz - 470 MHz), grounded shield, connection: type N



For GSM systems (0.8 GHz-2.25 GHz), grounded shield, connection: N type

ERC

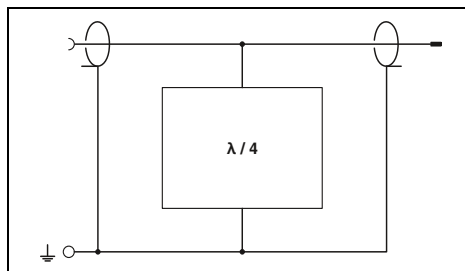

ERC

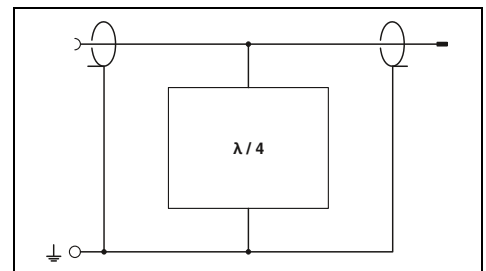

	Technical data	Technical data
<b>Electrical data</b>		
IEC test classification/EN type	C2 / C3 / D1	C2 / C3 / D1
Nominal current $I_N$	5 A (25°C)	5 A (25°C)
Nominal discharge current $I_n$ (8/20) $\mu$ s		
	Core-Shield / Core-Ground	Core-Shield / Core-Ground
Total surge current (8/20) $\mu$ s	20 kA / 20 kA	50 kA / 50 kA
Protection level $U_p$	30 kA	60 kA
	Core-Shield / Core-Ground	Core-Shield / Core-Ground
Frequency range	$\leq 95$ V (C2 - 10 kV / 5 kA) / $\leq 95$ V (C2 - 10 kV / 5 kA)	- / $\leq 5$ V (C1 - 1 kV/500 A)
Standing wave ratio SWR in a 50 $\Omega$ system	380 MHz ... 470 MHz	0.8 GHz ... 2.25 GHz
Permissible RF power $P_{max}$	typ. 1.05 ( $\leq 1.15$ )	typ. 1.2
General data	$\leq 800$ W	$\leq 500$ W
Dimensions W / H / D	32 mm / 32 mm / 83 mm	25 mm / 78.7 mm / 77.5 mm
Temperature range	-40°C ... 90°C	-40°C ... 85°C
Degree of protection in acc. with IEC 60529/EN 60529	IP68	IP68
Connection method	N connector	N connector 50 $\Omega$
Test standards	IEC 61643-21	IEC 61643-21/A1 / EN 61643-21/A1

	Ordering data			Ordering data			
Description	Type	Order No.	Pcs. / Pkt.	Type	Order No.	Pcs. / Pkt.	
<b>COAXTRAB</b> , protective adapter for antenna connections with Lambda/4 technology							
	Socket-socket	<b>CN-LAMBDA/4-0.47-BB</b>	<b>2800021</b>	1	<b>CN-LAMBDA/4-2.25-BB</b>	<b>2801057</b>	1
	Connector-socket	<b>CN-LAMBDA/4-0.47-SB</b>	<b>2800022</b>	1	<b>CN-LAMBDA/4-2.25-SB</b>	<b>2801056</b>	1
<b>Surge protection</b> for UMTS and quad-band GSM antenna, with SMA connector and SMA coupling							

	Accessories			Accessories		
Mounting plate, for individual attachment to housing panels	Type	Order No.	Pcs. / Pkt.	Type	Order No.	Pcs. / Pkt.
straight				<b>CN-UB/MP</b>	<b>2818135</b>	10
angled	<b>CN-UB/MP-90DEG-50</b>	<b>2803137</b>	10	<b>CN-UB/MP-90DEG-50</b>	<b>2803137</b>	10
<b>Adapter</b> , insertion loss <0.3 dB at 2.4 GHz						
N (male) -> SMA (female)	<b>RAD-ADP-N/M-SMA/F</b>	<b>2917036</b>	1	<b>RAD-ADP-N/M-SMA/F</b>	<b>2917036</b>	1
<b>Adapter cable</b> , pigtail, 50 $\Omega$ impedance;						
50 cm long, MCX (male) -> N (male)	<b>RAD-PIG-EF316-MCX-N</b>	<b>2867681</b>	1	<b>RAD-PIG-EF316-MCX-N</b>	<b>2867681</b>	1
30 cm long, N (female) -> SMA (male)	<b>RAD-PIG-EF316-N-SMA</b>	<b>2867694</b>	1	<b>RAD-PIG-EF316-N-SMA</b>	<b>2867694</b>	1





For GSM systems (0.8 GHz-2.25 GHz), grounded shield, connection: 7/16



For GSM systems (0.8 GHz - 2.25 GHz), grounded shield, connection: SMA



For GSM and WIMAX systems (2.4 GHz - 5.9 GHz), grounded shield, connection: type N

ERC

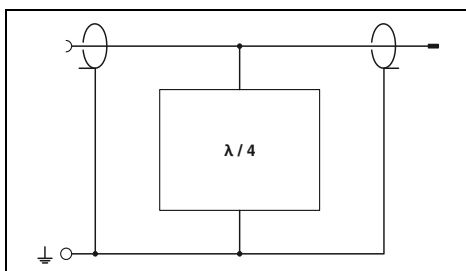
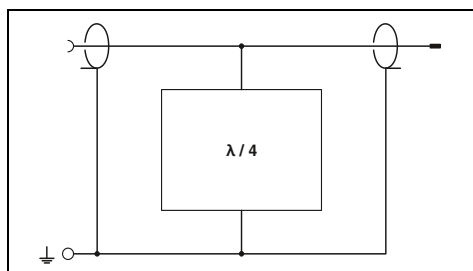

ERC

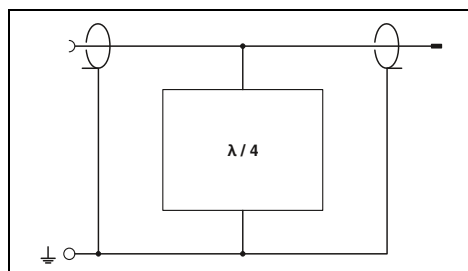

Technical data
C2 / C3 / D1 5 A (25°C)
50 kA / 50 kA 60 kA
-/ ≤ 5 V (C1 - 1 kV/500 A) 0.8 GHz ... 2.25 GHz typ. 1.2 ≤ 500 W
39 mm / 83.5 mm / 82 mm -40°C ... 85°C IP68 7/16 connector IEC 61643-21/A1 / EN 61643-21/A1

Technical data
C2 / C3 / D1 2 A (25°C)
6 kA / 6 kA 6 kA
-/ ≤ 5 V (C1 (1 kV/500 A)) 0.8 GHz ... 2.25 GHz ≤ 1.2 (0.8 GHz ... 2.25 GHz) ≤ 110 W (VSWR = 1.0)
46.5 mm / 25 mm / 70 mm -40°C ... 70°C IP55 SMA connector IEC 61643-21/A1 / EN 61643-21/A1

Technical data
C2 / C3 / D1 5 A (25°C)
50 kA / 50 kA 60 kA
-/ ≤ 11 V (6 kV/3 kA) 2.4 GHz ... 5.9 GHz typ. 1.1 (≤ 1.20 (2.4 GHz...5.9 GHz)) ≤ 500 W
26.1 mm / 38 mm / 60 mm -40°C ... 90°C IP68 N connector IEC 61643-21

Ordering data		
Type	Order No.	Pcs. / Pkt.
C7/16-LAMBDA/4-2.25-BB	2801060	1
C7/16-LAMBDA/4-2.25-SB	2801059	1
C5MA-LAMBDA/4-2.0-BS-SET	2800491	1

Ordering data		
Type	Order No.	Pcs. / Pkt.
CN-LAMBDA/4-5.9-BB	2838490	1
CN-LAMBDA/4-5.9-SB	2800023	1
CN-UB/MP	2818135	10
CN-UB/MP-90DEG-50	2803137	10
RAD-ADP-N/M-SMA/F	2917036	1
RAD-PIG-EF316-MCX-N	2867681	1

Ordering data		
Type	Order No.	Pcs. / Pkt.
CN-LAMBDA/4-5.9-BB	2838490	1
CN-LAMBDA/4-5.9-SB	2800023	1
CN-UB/MP	2818135	10
CN-UB/MP-90DEG-50	2803137	10
RAD-ADP-N/M-SMA/F	2917036	1
RAD-PIG-EF316-MCX-N	2867681	1

Accessories		
Type	Order No.	Pcs. / Pkt.
CN-UB/MP	2818135	10
CN-UB/MP-90DEG-50	2803137	10
RAD-ADP-N/M-SMA/F	2917036	1
RAD-PIG-EF316-MCX-N	2867681	1

Accessories		
Type	Order No.	Pcs. / Pkt.
CN-UB/MP	2818135	10
CN-UB/MP-90DEG-50	2803137	10
RAD-ADP-N/M-SMA/F	2917036	1
RAD-PIG-EF316-MCX-N	2867681	1

Accessories		
Type	Order No.	Pcs. / Pkt.
CN-UB/MP	2818135	10
CN-UB/MP-90DEG-50	2803137	10
RAD-ADP-N/M-SMA/F	2917036	1
RAD-PIG-EF316-MCX-N	2867681	1

# Surge protection and interference suppression filters

## Surge protection for transceiver systems

### For antenna inputs of radio and television equipment

#### C-SAT-BOX

- Protection for antenna inputs in satellite receiver technology
- For use upstream of antenna distributor or multi-switch
- Analog and digital SAT signals
- Terrestrial antenna signals
- Direct wall mounting supported

#### C-TV-SAT and C-TV/HIFI

- Protective adapter for antenna connections
- For use on broadband cable or SAT connection
- TV (IEC) or F connector

**Notes:**  
Attenuation characteristics at [phoenixcontact.net/products](http://phoenixcontact.net/products)



For antenna distributor or multi-switch, grounded shield, connection: F

ERC

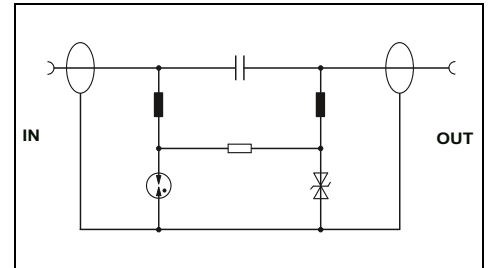

#### Technical data

Electrical data	
IEC test classification/EN type	B2 / C1 / C2 / C3 / D1
Maximum continuous operating voltage $U_c$	20 V DC / -
Nominal current $I_n$	400 mA (25°C)
Nominal discharge current $I_n$ (8/20) $\mu$ s	
Core-Shield / Core-Ground	2.5 kA / 2.5 kA
Total surge current (8/20) $\mu$ s	10 kA
Output voltage limitation at 1 kV/ $\mu$ s	
Core-Shield / Core-Ground	$\leq 80$ V / $\leq 80$ V
Cut-off frequency fg (3 dB)	
In a 75 $\Omega$ system	Symmetrical / Asymmetrical
	- / > 2.5 GHz
General data	
Dimensions W / H / D	145 mm / 72 mm / 32 mm
Temperature range	-25°C ... 55°C
Degree of protection in acc. with IEC 60529/EN 60529	IP40
Inflammability class in acc. with UL 94	-
Connection method	F connector
Test standards	-

#### Ordering data

Description	Type	Order No.	Pcs. / Pkt.
<b>COAXTRAB</b> , protective device for antenna distributors/multi-switches for insertion in the antenna line			
<b>COAXTRAB</b> , surge protection adapter			
	F connector TV connector		
		<b>2880561</b>	1

#### Accessories

<b>Adapter</b> , to connect the C-SAT-BOX with antenna distributors with a pitch of 20 mm (e.g. ASTRO, SPAUN)			
<b>Connecting cable</b> , to connect the C-SAT-BOX with the antenna distributor, length: 0.2 m			
	<b>ADAPTER KOAX TYP F</b>	<b>2880972</b>	5
	<b>KBL-SAT/20</b>	<b>2880985</b>	5



For TV equipment and SAT systems, grounded shield, connection: F or TV (IEC)

ERC

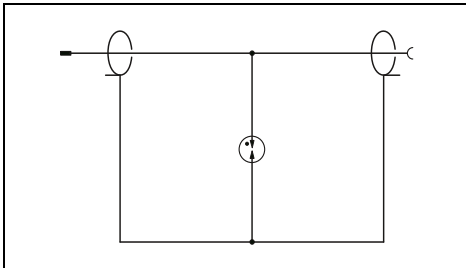

**Technical data**

F connector	TV connector
C1 / C2 / C3 / D1	C1 / C2 / C3 / D1
180 V DC / 130 V AC	180 V DC / 130 V AC
1.5 A (25°C)	1.5 A (25°C)
2.5 kA / - 2.5 kA	2.5 kA / - 2.5 kA
≤ 600 V / -	≤ 600 V / -
- / > 3 GHz	- / > 1 GHz

28 mm / 66 mm / 44 mm  
 -25°C ... 75°C  
 IP20  
 V0

F connector PAL-TV (IEC 169-2)  
 IEC 61643-21 / EN 50083 - CLASS A

**Ordering data**

Type	Order No.	Pcs. / Pkt.
C-TV-SAT	2856993	1
C-TV/HIFI	2857002	1

**Accessories**

Accessories	Order No.	Pcs. / Pkt.

# Surge protection and interference suppression filters

## Surge protection for transceiver systems

### Protection of video signals

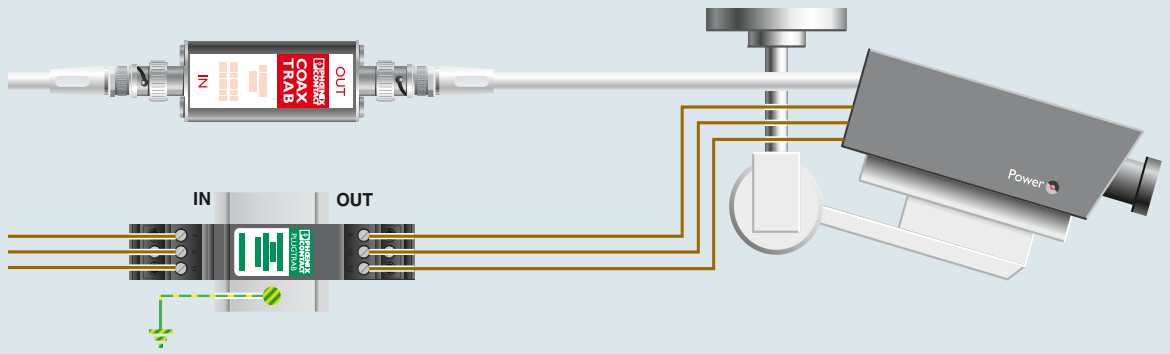
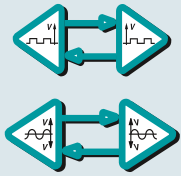

**C-UFB 5DC**  
2797858  
Page 127

**PT 3-HF-12DC-ST + PT 1X2-BE**  
2858043 + 2856113  
Page 90

### Protection of the SAT antenna connection

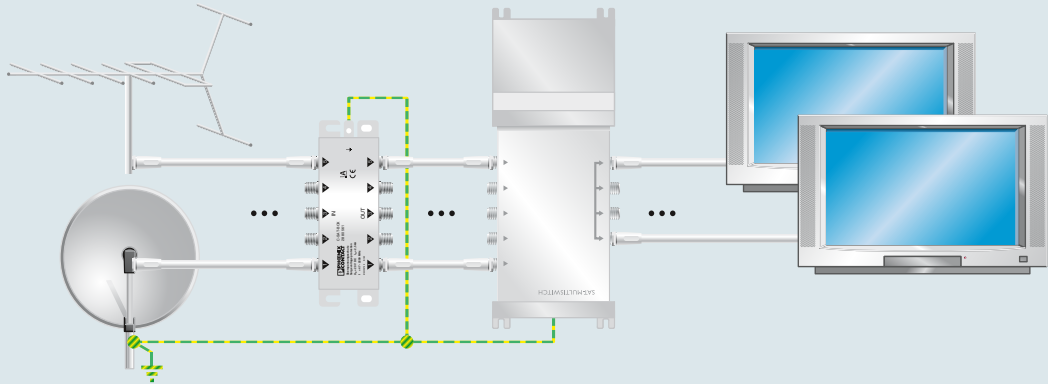
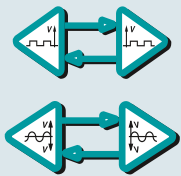

**C-SAT-BOX**  
2880561  
Page 130

### Protection of the cable TV connection

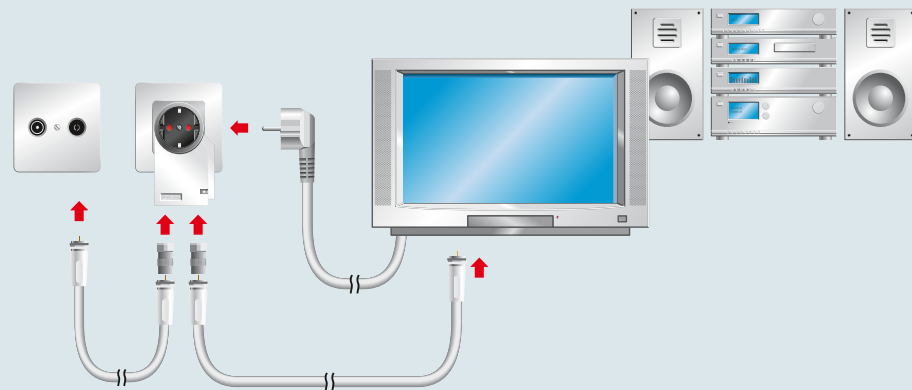
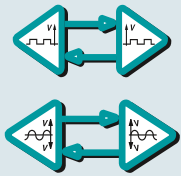

**MNT-TV-SAT D**  
2882284  
Page 57

### Protection of antenna signals

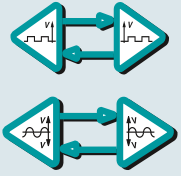

GPS  
GSM  
UMTS

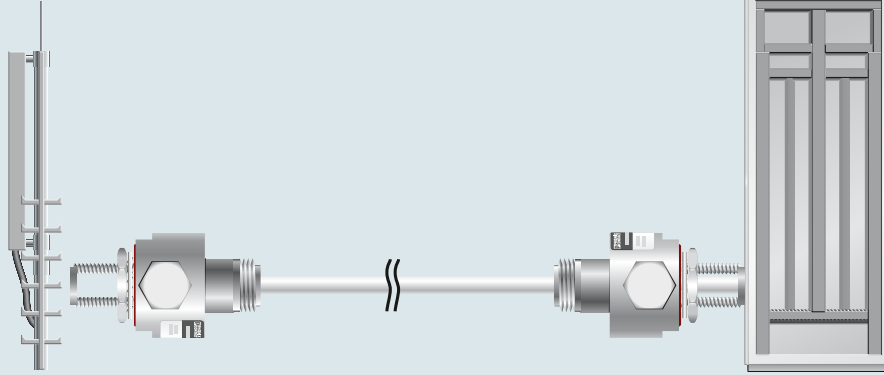

**CN-UB-280DC-3-BB**  
2801050  
Page 126

Optional

**CN-LAMBDA/4-2.25-BB**  
2801057  
Page 128

# Surge protection and interference suppression filters

## Accessories for surge protection

### Feed-through terminal block

- For wiring mixed combinations of lightning and surge arresters
- As a system extension for FLASHTRAB and VALVETRAB applications
- Practical wiring of all common applications



Feed-through terminal block

Electrical data		Technical data		
Maximum continuous operating voltage $U_c$		500 V AC/DC		
Nominal current $I_N$		125 A (30°C)		
Impulse discharge curr. $I_{imp}$ (10/350) $\mu$ s	Peak value	100 kA		
General data		Ordering data		
Dimensions W / H / D		17.7 mm / 89.8 mm / 65.5 mm		
Connection data solid / stranded / AWG		0.5 ... 35 mm <sup>2</sup> / 0.5 ... 25 mm <sup>2</sup> / 20 - 2		
Temperature range		-40°C ... 85°C		
Inflammability class in acc. with UL 94		V0		
Test standards		IEC 60947-7-1 / IEC 60947-7-1 / IEC 60947-7-1		
Description		Type	Order No.	Pcs. / Pkt.
Feed-through terminal block		DK-BIC-35	2749880	1

### Equipotential bonding and TRABTECH housing

#### Equipotential bonding strip

- For main equipotential bonding according to DIN VDE 0100
- As well as for lightning protection equipotential bonding in acc. with DIN EN 62305

#### TRABTECH housing

- Use in harsh environmental conditions at the installation location
- Installation outdoors or indoors possible



Equipotential bonding strip



IP65 protection class

Description	Ordering data			Ordering data		
	Type	Order No.	Pcs. / Pkt.	Type	Order No.	Pcs. / Pkt.
Equipotential bonding strip	PAS-1	2765615	1			
TRABTECH housing, for the isolated mounting of surge arresters				TG 40	2788896	1

### Marking material

- For clear and logical identification
- The multi-section ZB strips can be easily separated
- Can be marked with CMS computer marking system or by hand using B-STIFT



For terminal width of 6.2 mm



Marking label for the SEC product range

Description	Ordering data			Ordering data		
	Type	Order No.	Pcs. / Pkt.	Type	Order No.	Pcs. / Pkt.
<b>Marking labels</b> , corresponding material can be found on our website Can be marked acc. to customer specifications <b>UniCard materials</b> , can be marked with BLUEMARK, corresponding material can be found on our website	ZBN 18 CUS	0825059	1			
<b>Zack marker strip, 10-section, unprinted, printed</b> , corresponding material can be found on our website 5-section <b>Continuous roll</b> , width: 20 mm Color: white Color: yellow	UC-TM 6 GN	0818360	10			
	ZB 12:UNPRINTED	0812120	10			
				EML (20XE)R	0803452	1
				EML (20XE)R YE	0803453	1

### Shield fast connection and wiring bridges

- For connecting cable shielding to cable terminal points
- Easy assembly
- **Wiring bridges**
- 1, 3 or 4-phase with various numbers of positions
- Rated cross section per phase: 16 mm<sup>2</sup>
- End covers to terminate and insulate individually cut bridges



Shield fast connection



Wiring bridges

Description	Ordering data			Ordering data		
	Type	Order No.	Pcs. / Pkt.	Type	Order No.	Pcs. / Pkt.
<b>Shield fast connection</b> , for connection to PLUGTRAB PT For Ø 3-6 mm For Ø 5-10 mm	SSA 3-6	2839295	10			
	SSA 5-10	2839512	10			
<b>Wiring bridge</b> , for wiring applications with lightning and surge arresters, these can be found on our website under the corresponding items 57-pos.				MPB 18/1-57	2809238	1



### **CHECKMASTER 2 – the intelligent test device for surge protective devices**

Outdoor and indoor lightning protection must be regularly tested in accordance with normative requirements (IEC 62305) and official regulations. A basic visual check is not enough to identify damage to surge protective devices. Only an electrical check using the CHECKMASTER 2 produces meaningful results. The electrical check is performed with the aid of a programmable logic controller, a high-voltage source, and a constant current source. During the check, a program-controlled electrical test is performed on all the relevant components of the surge protective device. Thanks to the integrated database for surge protective devices, spark gaps, gas-filled surge protective devices, varistors, and suppressor diodes can be checked automatically. Surge protective devices that were previously damaged, surge protective devices that are nearing the electrical tolerance limits, and faulty surge protective devices can be safely identified.

In industries where high demands are placed on system availability, the CHECKMASTER 2 enables predictive maintenance to be carried out on surge protective devices. This provides additional security for failure-critical systems.

**i** Your web code: #0147





### Easy selection

The CHECKMASTER 2 has a modular design. Corresponding test adapters are available for the various surge protective devices. Further information about the test adapters required can be found on the next page.



### Convenient scanning

The barcodes on the surge protective devices present a fast and error-free solution for entering items. Plant-specific ID codes or user-defined designations can be entered via the color touch display or read from individually created barcode labels.



### Fast logging and easy data export

The tests are documented in accordance with IEC 62305. The CHECKMASTER 2 saves all test results to the internal memory with mains failure protection. The test reports are available via USB stick for convenient further processing in Office programs.

### CHECKMASTER 2

- Modular test device for plug-in surge protective devices from Phoenix Contact
- Easy and tool-free changing of test adapters
- Integrated programmable logic controller with high-voltage source and constant current source
- Automatic and program-controlled testing of surge protective devices
- Easy operation by means of color touch display with virtual keypad
- User interface: German, English; other languages in preparation
- Barcode scanner for automatic identification of surge protective devices and for reading user-specific barcodes (e.g., plant identification codes)
- Plant identification codes can also be entered using the virtual keypad
- USB interface for connecting standard USB sticks
- Easy transfer of test reports to Office programs and easy system software update via USB stick
- No additional software required
- No data cable required
- Robust plastic transport case; with removable lid
- Additional compartment for another test adapter
- Calibration certificate

Test adapters are not supplied as standard with the CHECKMASTER 2. The required test adapters must be ordered separately.

### PA-CASE 2 transport case for test adapters

- Padded compartments for holding test adapters for the CHECKMASTER 2
- Test adapters are not supplied as standard with the PA-CASE 2

Free software for updating the CHECKMASTER 2 can be found in the download area on the Phoenix Contact homepage.

The CHECKMASTER 2 is designed for use in industrial environments (EMC: class A product) and may not meet the requirements for radiated disturbance variables for use in residential areas.

Nominal voltage  $U_N$   
Ambient temperature (operation)

---

#### Description

**Test device**, for testing the correct function of surge protective devices from Phoenix Contact; test adapters must be ordered separately

**Transport case**, to hold four test adapters

**Test adapter**, for testing the correct function of surge protective devices from Phoenix Contact:  
FLASHTRAB FLT-CP/SEC and VALVETRAB VAL-CP/SEC

VALVETRAB VAL-MS  
PLUGTRAB PT/PLT  
COMTRAB CTM

---



Test device



Transport case



Test adapter

### Technical data

100 V AC ... 240 V AC  
5°C ... 35°C

### Ordering data

Type	Order No.	Pcs. / Pkt.
CHECKMASTER 2	2905256	1

### Ordering data

Type	Order No.	Pcs. / Pkt.
PA-CASE 2	2906272	1

### Ordering data

Type	Order No.	Pcs. / Pkt.
CM 2-PA-FLT/VAL-CP/SEC	2905283	1
CM 2-PA-VAL-MS	2905265	1
CM 2-PA-PT/PLT	2905284	1
CM 2-PA-CTM	2905282	1



### **FLT isolating spark gap for lightning protection equipotential bonding**

On the one hand, isolating spark gaps are used where electrical isolation is required between electrically conductive system parts and, on the other hand, where equipotential bonding is required in order to limit temporary voltage rises. These voltage rises can be caused by a direct lightning strike or a lightning event in the immediate vicinity.

### **Maximum discharge capacity**

The FLT isolating spark gap is designated for the maximum possible discharge class H and has been tested with surge currents of 100 kA with pulse shape (10/350  $\mu$ s) and (8/20  $\mu$ s).

### **Worldwide use in explosion-protected areas**

Thanks to the comprehensive approvals, installation in explosion-protected areas is possible worldwide.

### **Corrosion resistance**

The FLT isolating spark gap is particularly resistant when dealing with an aggressive surrounding atmosphere.

### **Low response voltage**

The FLT isolating spark gaps are characterized by a low impulse sparkover voltage of 1250 V (1.2/50  $\mu$ s). At the same time, the frequently required power-frequency withstand voltage of 250 V (50/60 Hz) is maintained. The parameters therefore comply with the recommendation of the working group for cathodic corrosion protection and meet DVGW requirements.

**i** Your web code: **#0148**



### Optimum coordination

Optimum protection is achieved thanks to precise coordination between the electric strength of the insulating sets for flanges and the response voltage of the isolating spark gap.



### Connecting material

For easy mounting, use the accessories that are available. Terminal boards (PL) and brackets (BR) are available for screw connections with a hole diameter of up to 42 mm and 62 mm respectively.



### Connecting cable

Pre-assembled connecting cables (CA) are available in three lengths. A lightning current absorbing connection is ensured by all accessory components.



### Pipeline segments

In modern pipelines, the pipes are assembled in segments and electrically isolated from one another. This means that cathodic corrosion protection can be used effectively. Insulating flanges act as connecting elements between the individual pipe segments. It is important to provide indirect equipotential bonding here.



### Indirect grounding

The isolating spark gap can also be used to implement indirect grounding of system parts. Typical fields of application include gas compression and distribution stations, for example.

## Isolating spark gap

### Isolating spark gap and accessories

new

- Isolating spark gap for indirect equipotential bonding
- Protection of insulating flanges in pipelines
- Can be used in Ex protection zone 1
- Accessories for lightning current absorbing connection



Spark gap

Ex:

#### Electrical data

Lightning protection class  
 Lightning surge current  $I_{imp}$  (10/350)  $\mu$ s  
 Nominal discharge current  $I_n$  (8/20)  $\mu$ s  
 Rated power-frequency withstand voltage  $U_{wAC}$   
 Rated DC withstand voltage  $U_{wDC}$   
 Rated impulse sparkover voltage  $U_{t,imp}$

H  
 100 kA  
 100 kA  
 $\leq 250$  V AC  
 $\leq 354$  V DC  
 $\leq 1.25$  kV

#### General data

Dimensions: length / housing diameter  
 Temperature range  
 Test standards

100 mm +2 mm / 45.50 mm  
 -20°C ... 60°C  
 IEC 62561-3 / EN 62561-3

#### Approvals

EC-type examination certificate according to ATEX  
 ATEX

DEKRA 14ATEX0050 X  
 II 2 G Ex d IIC T6 Gb  
 II 2 D Ex tb IIIC T80°C Db IP 66/67

IECEX

Ex d IIC T6 Gb  
 Ex tb IIIC T80°C Db IP66/67

#### Technical data

#### Ordering data

Description	Drill hole diameter	Type	Order No.	Pcs. / Pkt.
Isolating spark gap for the hazardous area		FLT-ISG-100-EX	2905579	1
Fixing bracket	11 mm 14 mm 18 mm 22 mm 26 mm 30 mm 33 mm 36 mm 39 mm 42 mm 48 mm 56 mm 62 mm			
Mounting rail	11 mm 14 mm 18 mm 22 mm 26 mm 30 mm 33 mm 36 mm 39 mm 42 mm			
Connecting cable, conductor cross section: 25 mm <sup>2</sup> , conductor designation: H01 N2-D				
Cable length: 100 mm				
Cable length: 200 mm				
Cable length: 300 mm				

new



Fixing bracket

new



Mounting rail

new



Connecting cable

Ordering data			Ordering data			Ordering data		
Type	Order No.	Pcs. / Pkt.	Type	Order No.	Pcs. / Pkt.	Type	Order No.	Pcs. / Pkt.
FLT-ISG-BR-11	2905580	1						
FLT-ISG-BR-14	2905581	1						
FLT-ISG-BR-18	2905582	1						
FLT-ISG-BR-22	2905583	1						
FLT-ISG-BR-26	2905757	1						
FLT-ISG-BR-30	2905758	1						
FLT-ISG-BR-33	2905759	1						
FLT-ISG-BR-36	2905760	1						
FLT-ISG-BR-39	2905761	1						
FLT-ISG-BR-42	2905762	1						
FLT-ISG-BR-48	2905763	1						
FLT-ISG-BR-56	2905764	1						
FLT-ISG-BR-62	2905765	1						
			FLT-ISG-PL-11	2905584	1			
			FLT-ISG-PL-14	2905586	1			
			FLT-ISG-PL-18	2905587	1			
			FLT-ISG-PL-22	2905588	1			
			FLT-ISG-PL-26	2905745	1			
			FLT-ISG-PL-30	2905746	1			
			FLT-ISG-PL-33	2905747	1			
			FLT-ISG-PL-36	2905754	1			
			FLT-ISG-PL-39	2905755	1			
			FLT-ISG-PL-42	2905756	1			
						FLT-ISG-CA-100	2905589	1
						FLT-ISG-CA-200	2905590	1
						FLT-ISG-CA-300	2905591	1



### Reliable signals with mains interference filters

Switching operations triggered mechanically or electronically generate pulse-like and high-frequency interference voltages. These voltages spread in an unimpeded manner across the cable network. All the devices within this cable network are affected. Data errors, uncontrolled functions, and system crashes can result, with data processing devices at particular risk.

### Interference voltage filters for power supply units

Interference suppression filters limit conducted high-frequency interference voltages. Devices used in data processing or automation particularly benefit from a clean power supply. The end result is safe operation and reliable measured results.

**i** Your web code: #0149



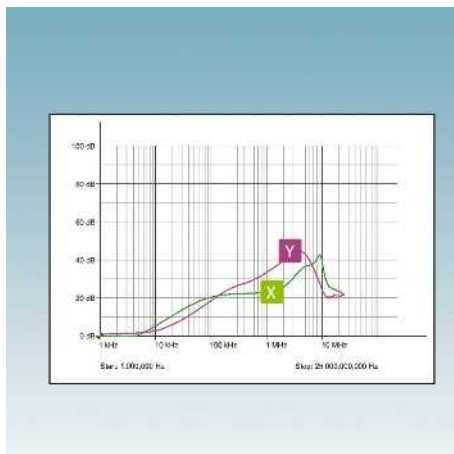
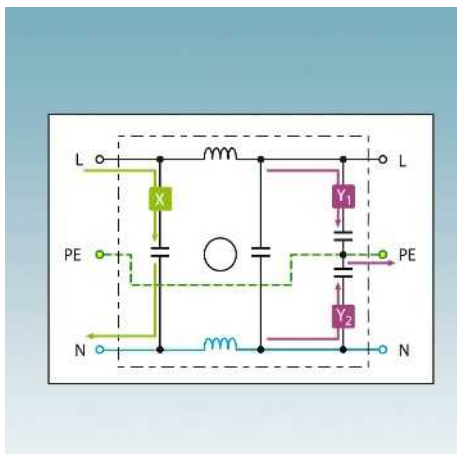

### Mains interference filters - operating principle and range

#### Filtering of symmetrical disturbance variables

**X** - Interference voltages between the phase and neutral conductor are filtered.

#### Filtering of asymmetrical disturbance variables

**Y<sub>1</sub>, Y<sub>2</sub>** - The opposite grounded interference voltages from phase to PE and from the neutral conductor to PE are filtered.

### Operating range of filters

An attenuation curve diagram illustrates the effective operating range of mains interference filters. The relevant frequency-dependent attenuation can be read according to the symmetrical or asymmetrical filter circuit.

### Interference suppression filters with type 3 surge protection

Interference suppression filters with integrated type 3 surge protection have two tasks: they absorb surge voltages and also limit high-frequency interference voltages.

Versions are available for the power supply and for signal circuits.

# Surge protection and interference suppression filters

## Interference suppression filters

### DIN-rail-mountable device protection with SFP-TRAB interference suppression filter

- Combined protective circuit for absorbing transient surge voltages and high-frequency interference voltages
- Thermal monitoring of the protective circuit
- Disconnection status signaled via floating remote indication contact
- Can be installed in industrial environments

**Notes:**  
Attenuation characteristics at phoenixcontact.net/products



20 A nominal current

Total width 112 mm

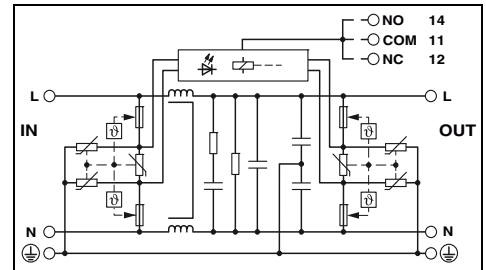

#### Technical data

Electrical data	... 230AC	... 120AC
IEC test classification/EN type	III / T3	III / T3
Nominal voltage $U_N$	240 V AC	120 V AC
Maximum continuous operating voltage $U_C$	DC / AC - / 264 V AC	- / 150 V AC
Nominal load current $I_L$	20 A (40°C)	20 A (40°C)
Combined surge $U_{OC}$	10 kV (5 kA)	6 kV (3 kA)
Protection level $U_p$	L-N / L(N)-PE $\leq 1 \text{ kV} / \leq 1 \text{ kV}$	$\leq 450 \text{ V} / \leq 450 \text{ V}$
Response time $t_A$	L-N / L(N)-PE $\leq 25 \text{ ns} / \leq 25 \text{ ns}$	$\leq 25 \text{ ns} / \leq 25 \text{ ns}$
Max. backup fuse in acc. with IEC	20 A (MCB B/general purpose)	20 A (MCB B/general purpose)
Input attenuation $a_i$	Symmetrical Asymmetrical	20 dB ( $\geq 100 \text{ kHz} / 50 \Omega$ ) 30 dB ( $\geq 1 \text{ MHz} / 50 \Omega$ )
Inductance		2x 1 mH $\pm 30\%$ (with current compensation) 2x 1 mH $\pm 30\%$ (with current compensation)
General data	112 mm / 93 mm / 79 mm	
Dimensions W / H / D	2.5 ... 6 mm <sup>2</sup> / 2.5 ... 4 mm <sup>2</sup> / 14 - 10	
Connection data solid / stranded / AWG	-25°C ... 70°C	
Temperature range	-25°C ... 70°C	
Inflammability class in acc. with UL 94	V-0	
Test standards	IEC 61643-11 / EN 61643-11 / UL 1449 / UL 1283	
Remote indication contact	PDT contact	
Connection data solid / stranded / AWG	0.14 ... 1.5 mm <sup>2</sup> / 0.14 ... 1.5 mm <sup>2</sup> / 28 - 16	
Max. operating voltage	250 V AC / -	
Max. operating current	1 A (250 V AC) / 0.25 A (250 V DC) / 1 A (48 V DC)	

#### Ordering data

Description	Voltage $U_N$	Type	Order No.	Pcs. / Pkt.
<b>SFP-TRAB</b> , DIN-rail-mountable device protection with integrated mains interference filter and optical signaling				
Nominal current: 20 A	240 V AC	<b>SFP 1-20/230AC</b>	<b>2859987</b>	1
Nominal current: 20 A	120 V AC	<b>SFP 1-20/120AC</b>	<b>2856702</b>	1
<b>SFP-TRAB</b> , DIN-rail-mountable device protection with integrated mains interference filter and optical signaling				
Nominal current: 5 A	120 V AC			
Nominal current: 10 A	120 V AC			
Nominal current: 15 A	120 V AC			



5 A nominal current



10 A nominal current



15 A nominal current

Total width 112 mm

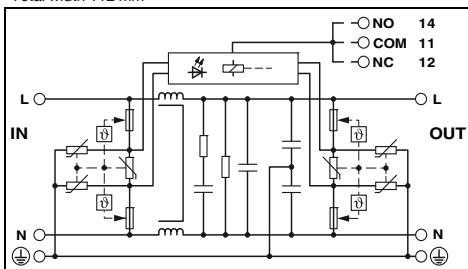

### Technical data

III / T3  
120 V AC  
- / 150 V AC  
5 A (70°C)  
6 kV (3 kA)  
≤ 450 V / ≤ 450 V  
≤ 25 ns / ≤ 25 ns  
20 A (MCB B/general purpose)

20 dB (≥ 100 kHz / 50 Ω)  
30 dB (≥ 1 MHz / 50 Ω)  
2x 1 mH ±30% (with current compensation)

112 mm / 93 mm / 79 mm  
2.5 ... 6 mm<sup>2</sup> / 2.5 ... 4 mm<sup>2</sup> / 14 - 10  
-25°C ... 70°C

V-0  
IEC 61643-1 / EN 61643-11/A11 / UL 1449 /  
UL 1283

PDT, 1-pos.  
0.14 ... 1.5 mm<sup>2</sup> / 0.14 ... 1.5 mm<sup>2</sup> / 28 - 16  
250 V AC / -  
1 A (250 V AC) / 0.25 A (250 V DC) / 1 A (48 V DC)

Total width 112 mm

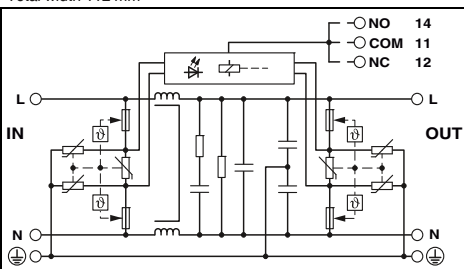

### Technical data

III / T3  
120 V AC  
- / 150 V AC  
10 A (60°C)  
6 kV (3 kA)  
≤ 450 V / ≤ 450 V  
≤ 25 ns / ≤ 25 ns  
20 A (MCB B/general purpose)

20 dB (≥ 100 kHz / 50 Ω)  
30 dB (≥ 1 MHz / 50 Ω)  
2x 1 mH ±30% (with current compensation)

112 mm / 93 mm / 79 mm  
2.5 ... 6 mm<sup>2</sup> / 2.5 ... 4 mm<sup>2</sup> / 14 - 10  
-25°C ... 70°C

V-0  
IEC 61643-1 / EN 61643-11/A11 / UL 1449 /  
UL 1283

PDT contact  
0.14 ... 1.5 mm<sup>2</sup> / 0.14 ... 1.5 mm<sup>2</sup> / 28 - 16  
250 V AC / -  
1 A (250 V AC) / 0.25 A (250 V DC) / 1 A (48 V DC)

Total width 112 mm

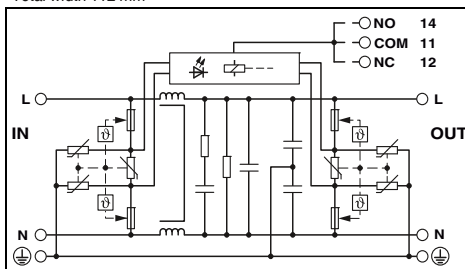

### Technical data

III / T3  
120 V AC  
- / 150 V AC  
15 A (50°C)  
6 kV (3 kA)  
≤ 450 V / ≤ 450 V  
≤ 25 ns / ≤ 25 ns  
20 A (MCB B/general purpose)

20 dB (≥ 100 kHz / 50 Ω)  
30 dB (≥ 1 MHz / 50 Ω)  
2x 1 mH ±30% (with current compensation)

112 mm / 93 mm / 79 mm  
2.5 ... 6 mm<sup>2</sup> / 2.5 ... 4 mm<sup>2</sup> / 14 - 10  
-25°C ... 70°C

V-0  
IEC 61643-1 / EN 61643-11/A11 / UL 1449 /  
UL 1283

PDT contact  
0.14 ... 1.5 mm<sup>2</sup> / 0.14 ... 1.5 mm<sup>2</sup> / 28 - 16  
250 V AC / -  
1 A (250 V AC) / 0.25 A (250 V DC) / 1 A (48 V DC)

### Ordering data

Type	Order No.	Pcs. / Pkt.
SFP 1-5/120AC	2920667	1

### Ordering data

Type	Order No.	Pcs. / Pkt.
SFP 1-10/120AC	2920670	1

### Ordering data

Type	Order No.	Pcs. / Pkt.
SFP 1-15/120AC	2920683	1

# Surge protection and interference suppression filters

## Interference suppression filters

### TERMITRAB

<b>Notes:</b>
Attenuation characteristics at <a href="http://phoenixcontact.net/products">phoenixcontact.net/products</a>

- Combined protective circuit for absorbing transient surge voltages and high-frequency interference voltages
- With spring-cage connection
- Disconnection of signal circuits by disconnect knife

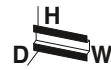

Protection for two conductors with a common reference potential

ERIC®

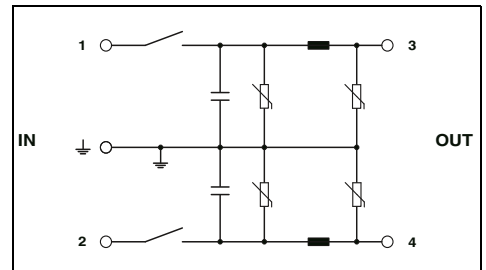

<b>Electrical data</b>	
IEC test classification/EN type	C1 / C3
Maximum continuous operating voltage $U_c$	DC / AC 38 V DC / 30 V AC
Rated load current $I_n$	0.5 A (55°C)
Nominal discharge current $I_n$ (8/20) $\mu$ s	
Total surge current (8/20) $\mu$ s	Core-Ground 350 A
Output voltage limitation at 1 kV/ $\mu$ s	700 A
Cut-off frequency fg (3 dB)	Core-Ground $\leq$ 70 V
Resistance per path	Asymmetrical in the 50 $\Omega$ system typ. 60 kHz
Inductance per path	0.5 $\Omega$
Capacitance per path	100 $\mu$ H (per path)
	130 nF
<b>General data</b>	
Connection data solid / stranded / AWG	0.2 ... 4 mm <sup>2</sup> / 0.2 ... 2.5 mm <sup>2</sup> / 24 - 12
Temperature range	-40°C ... 85°C
Degree of protection in acc. with IEC 60529/EN 60529	IP20
Inflammability class in acc. with UL 94	V2
Test standards	IEC 61643-21/A1 / EN 61643-21/A1

### Technical data

<b>Description</b>	<b>Voltage <math>U_N</math></b>
<b>TERMITRAB</b> , spring-cage modular terminal block with integrated surge protection as a filter circuit and disconnect knives, for mounting on NS 35	24 V AC

### Ordering data

Type	Order No.	Pcs. / Pkt.
TT-ST-M-SFP-24AC	2858946	10

<b>Cover</b> , for terminating a row of terminal blocks
---------------------------------------------------------

Accessories		
TT-D-STTCO-BK	2858894	50

**FILTRAB**

- Low pass filters for nominal currents of 1 to 10 A
- For single-phase circuits
- DIN rail module

**Notes:**  
Attenuation characteristics at phoenixcontact.net/products

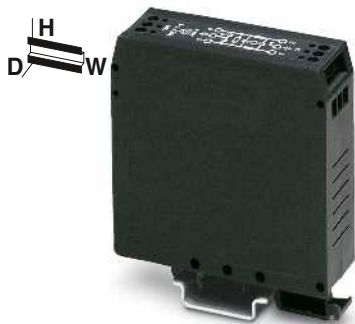

1 A / 3 A nominal current



6 A / 10 A nominal current

ERIC   
Total width 25 mm

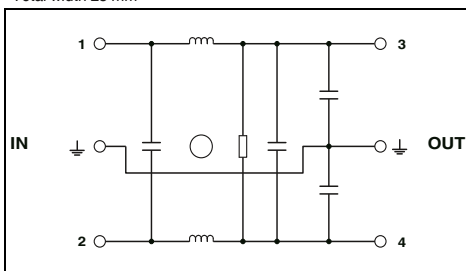

ERIC   
Total width 40 mm

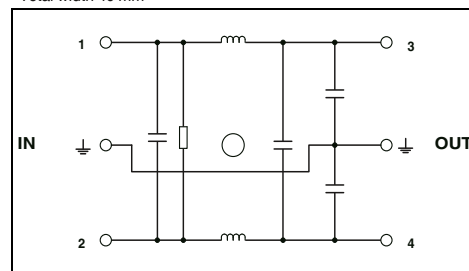

**Technical data**

NEF 1-1	NEF 1-3
240 V AC	240 V AC
264 V AC	264 V AC
1 A (40°C)	3 A (40°C)
1 A (gL)	3 A (gL)
2x 10 mH	2x 2.7 mH
Symmetrical	Asymmetrical
≥ 65 dB (50 Ω/ 1 MHz)	≥ 55 dB (50 Ω/ 1 MHz)
≥ 45 dB (50 Ω/ 1 MHz)	≥ 35 dB (50 Ω/ 1 MHz)

**Technical data**

NEF 1-6	NEF 1-10
240 V AC	240 V AC
264 V AC	264 V AC
6 A (40°C)	10 A (40°C)
6.3 A (gL/C)	10 A (gL)
2x 2.7 mH	2x 1.8 mH
> 80 dB (50 Ω/ 1 MHz)	> 80 dB (50 Ω/ 1 MHz)
> 40 dB (50 Ω/ 1 MHz)	> 40 dB (50 Ω/ 1 MHz)

Electrical data	
Nominal voltage $U_N$	L - N
Maximum continuous operating voltage $U_C$	264 V AC
Nominal load current $I_L$	1 A (40°C)
Max. backup fuse in acc. with IEC	1 A (gL)
Inductance	2x 10 mH
Input attenuation $a_i$	Symmetrical: ≥ 65 dB (50 Ω/ 1 MHz) Asymmetrical: ≥ 45 dB (50 Ω/ 1 MHz)
General data	
Dimensions W / H / D	25 mm / 79.4 mm / 84.15 mm
Connection data solid / stranded / AWG	0.2 ... 4 mm <sup>2</sup> / 0.2 ... 2.5 mm <sup>2</sup> / 24 - 12
Temperature range	-25°C ... 100°C (HMF)
Inflammability class in acc. with UL 94	V2
Test standards	IEC 60939-2 / DIN EN 60939-2

**Ordering data**

Type	Order No.	Pcs. / Pkt.
NEF 1-1	2794123	10
NEF 1-3	2794110	10

**Ordering data**

Type	Order No.	Pcs. / Pkt.
NEF 1-6	2783082	5
NEF 1-10	2788977	5

Description	Nominal load current $I_L$
<b>FILTRAB</b> , interference suppression filter for single-phase circuits, for mounting on NS 32 or NS 35...	1 A
	3 A
	6 A
	10 A



# Power supplies and UPS

## For superior system availability

The product ranges differ with regard to their design, performance, and functionality. Select the ideal solution based on your requirements:

- QUINT POWER - maximum functionality
- TRIO POWER - robust standard functionality
- UNO POWER - compact basic functionality

The product range is supplemented with designs tailor-made for specific applications:

- MINI POWER for measurement and control technology
- STEP POWER for installation distributors

## Power supply units

Thanks to high-quality products featuring leading technology, our QUINT, TRIO, UNO, MINI and STEP POWER product ranges optimally equip you for international competition.

## DC/DC converters

Change the voltage level, regenerate the voltage at the end of long cables or enable the creation of independent supply systems with the QUINT and MINI DC/DC converters.

## Redundancy modules

A redundant power supply system is the result of the parallel connection of two power supply units. Optimize this solution with the QUINT ORING redundancy modules and the QUINT, TRIO, UNO, and STEP diodes for maximum system availability.

## Uninterruptible power supply (UPS) units for control cabinets

IQ technology is the key to an intelligent power supply solution. The UPS monitors and optimizes the power storage. Avoid interruptions when working with the intelligent UPS for non-stop power.

 Your web code: #0150





## Power supplies and UPS

<b>Selection guide</b>	<b>152</b>
<b>Power supply units</b>	<b>156</b>
QUINT POWER	158
QUINT POWER, with protective coating	166
TRIO POWER	168
UNO POWER	174
MINI POWER	182
STEP POWER	186
<b>DC/DC converters</b>	<b>194</b>
QUINT DC/DC converters	196
QUINT DC/DC converters, with protective coating	202
MINI DC/DC converters	204
<b>Redundancy modules</b>	<b>206</b>
QUINT ORING	208
TRIO DIODE	210
QUINT DIODE	212
STEP DIODE	213
UNO DIODE	213
<b>Accessories</b>	<b>214</b>
<b>Uninterruptible power supply units for the control cabinet</b>	<b>216</b>
Selection guide for QUINT UPS	218
QUINT UPS	220
Power storage for QUINT UPS	224
Accessories	230
Selection guide for UPS modules	232
UPS module with integrated power storage	234
UPS module with integrated power supply unit	238
Power storage for TRIO UPS and MINI UPS	240
<b>Uninterruptible power supply units for 19" racks/towers</b>	<b>244</b>





# Power supplies and UPS

## Selection guides

### QUINT POWER 1~

				
24 DC / 3.5 A Page 158	24 DC / 5 A Page 158	24 DC / 10 A Page 158 12 DC / 15 A Page 162 48 DC / 5 A Page 162	24 DC / 20 A Page 158 12 DC / 20 A Page 162 48 DC / 10 A Page 162	24 DC / 40 A Page 158 48 DC / 20 A Page 162







### QUINT POWER 3~

			
24 DC / 5 A Page 160	24 DC / 10 A Page 160	24 DC / 20 A Page 160	24 DC / 40 A Page 160 48 DC / 20 A Page 164

### QUINT POWER, with protective coating 1~, 3~

			
1AC/24 DC / 5 A CO Page 166	1AC/24 DC / 10 A CO Page 166	1AC/24 DC / 20 A CO Page 166	3AC/24 DC / 20 A CO Page 166





### TRIO POWER 1~

					
24 DC / 3 A Page 168	24 DC / 5 A Page 168	24 DC / 10 A Page 168	24 DC / 20 A Page 168	12 DC / 5 A Page 172	12 DC / 10 A Page 172

### TRIO POWER 1~







48 DC / 5 A Page 172

### TRIO POWER 3~





				
48 DC / 10 A Page 172	24 DC / 5 A Page 170	24 DC / 10 A Page 170	24 DC / 20 A Page 170	24 DC / 40 A Page 170









UNO POWER 1~

					
<b>24 DC / 30 W</b> Page 174	<b>24 DC / 60 W</b> Page 174	<b>24 DC / 100 W</b> Page 174	<b>24 DC / 150 W</b> Page 174	<b>24 DC / 240 W</b> Page 174	<b>24 DC / 90 W</b> Page 176
<b>15 DC / 30 W</b> Page 178	<b>48 DC / 60 W</b> Page 180	<b>48 DC / 100 W</b> Page 180			
<b>12 DC / 30 W</b> Page 176	<b>15 DC / 55 W</b> Page 178	<b>15 DC / 100 W</b> Page 178			
<b>5 DC / 25 W</b> Page 178	<b>12 DC / 55 W</b> Page 176	<b>12 DC / 100 W</b> Page 176			
	<b>5 DC / 40 W</b> Page 178	<b>24 DC / 90 W</b> Page 176			

MINI POWER 1~

				
<b>24 DC / 1.3 A</b> Page 182	<b>24 DC / 1.5 A</b> Page 182	<b>24 DC / 2 A</b> Page 182	<b>24 DC / 4 A</b> Page 182	<b>1 AC / 24 DC / 1.5 A EX</b> Page 184
<b>5 DC / 3 A</b> Page 184		<b>10 - 15 DC / 2 A</b> Page 184	<b>24 DC / 100 W</b> Page 182	
		<b>±15 DC / 1 A</b> Page 184	<b>10 - 15 DC / 8 A</b> Page 184	

STEP POWER 1~

					
<b>24 DC / 0.5 A</b> Page 186	<b>24 DC / 0.75 A / FL</b> Page 186	<b>24 DC / 0.75 A</b> Page 186	<b>24 DC / 1.75 A</b> Page 188	<b>24 DC / 2.5 A</b> Page 188	<b>24 DC / 4.2 A</b> Page 188
<b>48 AC / 24 DC / 0.5 A</b> Page 186	<b>12 DC / 1.5 A / FL</b> Page 192	<b>12 DC / 1.5 A</b> Page 192	<b>12 DC / 3 A</b> Page 192	<b>5 DC / 6.5 A</b> Page 190	<b>24 DC / 100 W</b> Page 188
<b>12 DC / 1 A</b> Page 192				<b>12 DC / 5 A</b> Page 192	<b>48 DC / 2 A</b> Page 190
<b>5 DC / 2 A</b> Page 190				<b>15 DC / 4 A</b> Page 190	<b>277 AC / 24 DC / 3.5 A</b> Page 188

## Selection guides

### QUINT DC/DC converters



	
<b>24 DC / 24 DC / 5 A</b> Page 196	<b>24 DC / 24 DC / 10 A</b> Page 196
<b>24 DC / 12 DC / 8 A</b> Page 196	<b>24 DC / 48 DC / 5 A</b> Page 196
<b>48 DC / 24 DC / 5 A</b> Page 200	<b>48 DC / 48 DC / 5 A</b> Page 200
<b>12 DC / 24 DC / 5 A</b> Page 198	<b>60-72DC/24DC/10A</b> Page 200
<b>12 DC / 12 DC / 8 A</b> Page 198	<b>96-110DC/24DC/10A</b> Page 200





### QUINT DC/DC converters, with protective coating

			
<b>24DC/24 DC/5 A/CO</b> Page 202	<b>60-72DC/24DC/10A/CO</b> Page 202	<b>24DC/24 DC/10 A/CO</b> Page 202	<b>24DC/24 DC/20 A/CO</b> Page 202
	<b>96-110DC/24DC/10A/CO</b> Page 202		





### MINI DC/DC converters

	
<b>12-24 DC/24 DC / 1 A</b> Page 204	<b>AC power module</b> Page 204
<b>48-60 DC/24 DC / 1 A</b> Page 204	
<b>12-24 DC/5 - 15 DC/2 A</b> Page 204	
<b>12-24 DC/48 DC / 0.7 A</b> Page 204	

### For frequency inverters

	
<b>2AC/1DC/24DC/20A</b> Page 165	<b>600 DC/24 DC / 20 A</b> Page 172

### Redundancy modules - QUINT

			
<b>24 DC / 2x10 A</b> Page 208	<b>24 DC / 2x20 A</b> Page 208	<b>24 DC / 2x40</b> Page 208	<b>12 - 24 DC / 2x20 A</b> Page 212
			<b>48 DC / 2x20 A</b> Page 212

### - TRIO

<b>12 - 24 DC / 2x10 A</b> Page 210
<b>48 DC / 2x10 A</b> Page 210





### - UNO

<b>5 - 24 DC/2x10/1x20</b> Page 212

### - STEP

<b>5 - 24 DC / 2x5 A</b> Page 212

**QUINT DC-UPS**

				
<b>24 DC / 5 A</b> Page 220	<b>24 DC / 10 A</b> Page 220	<b>24 DC / 20 A</b> Page 220	<b>24 DC / 40 A</b> Page 220	<b>12 DC/5 A/24 DC/10 A</b> Page 222

**QUINT AC-UPS**

<b>1 AC / 1 AC / 500 VA</b> Page 223

**UPS-CAP**

<b>24 DC / 10 A / 10 KJ</b> Page 224

<b>24 DC / 20 A / 20 KJ</b> Page 224

**UPS-BAT/LI-ION**

<b>24 DC / 120 WH</b> Page 225

**UPS-BAT/VRLA-WTR**

<b>24 DC / 13 AH</b> Page 228

<b>24 DC / 26 AH</b> Page 228

**UPS-BAT/VRLA**

<b>24 DC / 1.3 AH</b> Page 226



<b>24 DC / 3.4 AH</b> Page 226

<b>24 DC / 7.2 AH</b> Page 226

<b>24 DC / 12 AH</b> Page 226

<b>24 DC / 38 AH</b> Page 226

**UPS with integrated QUINT, UNO, STEP power storage**

<b>24 DC / 5 A / 1.3 AH</b> Page 234

<b>24 DC / 10 A / 3.4 AH</b> Page 234

<b>24 DC / 60 W</b> Page 237

<b>24 DC / 3 A</b> Page 236 <b>12 DC / 4 A</b> Page 236

**QUINT-BUFFER**

<b>24 DC / 40 A</b> Page 235

**MINI UPS with integrated power supply + power storage**

<b>1 AC / 24 DC / 2 A</b> Page 239 <b>1 AC / 12 DC / 4 A</b> Page 239



<b>24 DC / 1.3 AH</b> Page 242 <b>12 DC / 2.6 AH</b> Page 242

<b>24 DC / 0.8 AH</b> Page 242 <b>12 DC / 1.6 AH</b> Page 242

**TRIO UPS with integrated power supply + power storage**

<b>1 AC / 24 DC / 5 A</b> Page 238

<b>24 DC / 3.4 AH</b> Page 240

<b>24 DC / 7.2 AH</b> Page 240

<b>24 DC / 12 AH</b> Page 240



### Leading technology and high quality – power supplies for superior system availability.

Thanks to high-quality products featuring leading technology, with our power supply solutions from the QUINT, TRIO, UNO, MINI, and STEP POWER product ranges, you are optimally equipped to handle competitors on an international scale.

Functionality, performance class, and design are tailored to the demands of various different sectors and always offer the ideal solution. Choose from our wide range of power supply units and DC/DC converters.

### QUINT POWER – maximum functionality

Cost-effective selective fuse protection with SFB technology:

In order to trip standard circuit breakers magnetically and quickly, power supply units must be able to supply several times the nominal current for a short period. With SFB (selective fuse breaking) technology, which supplies up to 6 times the nominal current for 12 ms, a dynamic power reserve is available. Faulty current paths are selectively switched off, the fault is isolated, and important system components remain operational.

**Preventive function monitoring:**  
Comprehensive diagnostics are provided through constant monitoring of the output voltage and output current. This preventive function monitoring visualizes critical operating states, before errors can occur. The remote monitoring takes place by means of active switching outputs and floating relay contacts.

**Power reserve POWER BOOST:**  
The static power reserve offers up to 1.5 times the nominal current permanently. At ambient temperatures of up to +40°C the POWER BOOST is continuously available and at higher temperatures, it is available for a few minutes. This ensures that both high inrush currents of capacitive loads, as well as loads with DC/DC converters in the primary circuit, can be reliably supplied.

### TRIO POWER – robust standard functionality

The reliable supply of the loads under challenging ambient conditions is ensured by the power supply units, which feature an extremely robust electrical and mechanical design. TRIO POWER supplies up to 1.5 times the nominal current for five seconds with the dynamic BOOST. Loads with high starting currents can therefore be started without other loads being affected by voltage dips.

### UNO POWER – compact basic functionality

UNO POWER offers maximum energy efficiency thanks to high efficiency of up to 94% and low idling losses below 0.3 W. The extremely high power density of up to 325 W/dm<sup>3</sup> enables a very compact design. Thanks to the wide range of products and the temperature range from -25°C to +70°C, the devices support flexible use.

**i Your web code: #0151**

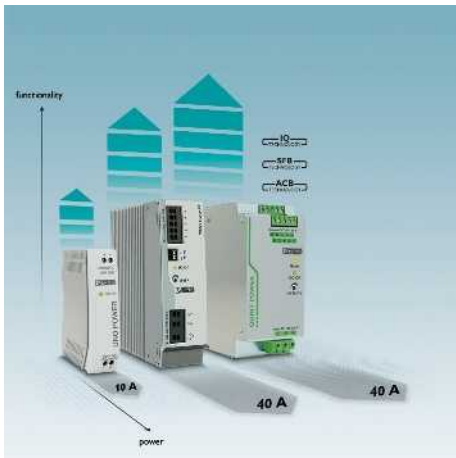

**Power supply units - a comparison of the advantages**

- QUINT POWER - maximum flexibility up to 1000 W
- TRIO POWER - robust standard functionality up to 1000 W
- UNO POWER - compact basic functionality up to 240 W



**QUINT POWER**

- The unique SFB technology and preventive function monitoring maximize the availability of your application.
- Quick tripping of standard circuit breakers with SFB technology
  - Preventive function monitoring
  - Reliable starting of difficult loads with POWER BOOST



**TRIO POWER**

- Standard functionality combined with high quality and reliability – this makes the power supplies ideal for use in machine building.
- Robust design
  - Reliable supply of loads with high switching currents with the dynamic BOOST
  - Time savings during installation thanks to push-in connection technology



**UNO POWER**

- The UNO POWER power supply units offer extremely compact basic functionality.
- The wide range of products covers all common voltage levels
  - Save energy thanks to high efficiency and low idling losses
  - Compact design saves space in the control cabinet



**MINI POWER - for measurement and control technology**

- The MINI POWER comes into its own in fields where modular electronics housing has become the standard.
- Service-friendly connection technology: coded COMBICON connectors
  - Active function monitoring with switching output for remote monitoring of the output voltage



**STEP POWER - for installation distributors and flat control panels**

- The low idling losses and high efficiency make the STEP POWER the most energy efficient in its class.
- Flexible: snap onto the DIN rail or screw onto a level surface

# Power supplies and UPS

## Power supply units

### QUINT POWER power supplies – maximum functionality

#### QUINT POWER, 1 AC, 24 V DC

- Quick tripping of standard circuit breakers thanks to the dynamic power reserve SFB (selective fuse breaking) technology with up to 6 times the nominal current for 12 ms
- Reliable starting of difficult loads with the static POWER BOOST power reserve with up to 1.5 times the nominal current permanently
- Preventive function monitoring warns against critical operating states before errors occur
- Flexible thanks to input voltage ranges for AC and DC voltages
- Approved for semiconductor production according to SEMI F47-0706



Power supply,  
1 AC, 24 V DC, 3.5 A

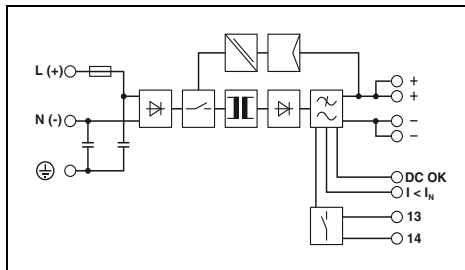

#### Technical data

Input data	
Nominal input voltage range	100 V AC ... 240 V AC
Input voltage range	85 V AC ... 264 V AC / 90 V DC ... 350 V DC
Frequency range	45 Hz ... 65 Hz / 0 Hz
Current consumption (nominal load)	1.4 A (120 V AC) / 0.8 A (230 V AC)
Inrush current limitation at 25°C (typ.) / I <sup>2</sup> t	< 20 A / < 2 A <sup>2</sup> s
Mains buffering (I <sub>N</sub> , typ.)	> 20 ms (120 V AC) / > 80 ms (230 V AC)
Output data	
Nominal output voltage	24 V DC ±1 %
Setting range of the output voltage	18 V DC ... 29.5 V DC (> 24 V constant capacity)
Output current / POWER BOOST / SFB (12 ms)	3.5 A / 4 A / 15 A
Magnetic fuse tripping	B2
Can be connected in parallel / series	Yes / Yes
Max. power dissipation (no load / nominal load)	3.5 W / 11 W
Efficiency (typ.)	> 88% (for 230 V AC and nominal values)
Residual ripple	< 50 mV <sub>pp</sub>
Signaling	
Signaling DC OK	LED, active switching output, relay contact
Boost signaling	LED, active switching output
General data	
Weight / Dimensions W x H x D	0.5 kg / 32 x 130 x 125 mm
Spacing when mounting	Alignable: 5 mm horizontally, 15 mm next to active components, 50 mm vertically
Connection method	Plug-in screw connection
Input connection data (solid / stranded / AWG)	0.2 - 2.5 mm <sup>2</sup> / 0.2 - 2.5 mm <sup>2</sup> / 20 - 12
Output connection data (solid / stranded / AWG)	0.2 - 2.5 mm <sup>2</sup> / 0.2 - 2.5 mm <sup>2</sup> / 20 - 12
Signal connection data (solid / stranded / AWG)	0.2 - 2.5 mm <sup>2</sup> / 0.2 - 2.5 mm <sup>2</sup> / 20 - 12
Degree of protection / Protection class	IP20 / I
MTBF (IEC 61709, SN 29500)	> 820000 h (40°C)
Ambient temperature (operation)	-25°C ... 70°C (> 60°C derating: 2.5%/K)
Standards/regulations	
Insulation voltage input/output	2 kV AC (routine test) / 4 kV AC (type test)
Electromagnetic compatibility	Conformance with EMC Directive 2004/108/EC
Electrical safety	IEC 60950-1/VDE 0805 (SELV)
Electronic equipm. for electrical power installations	EN 50178/VDE 0160 (PELV)
Safe isolation	DIN VDE 0100-410, DIN VDE 0106-1010
Medical standard	IEC 60601
UL approvals	UL Listed UL 508, UL/C-UL Recognized UL 60950-1, UL ANSI/ISA-12.12.01 Class I, Division 2, Groups A, B, C, D (Hazardous Location)
Limitation of harmonic line currents	EN 61000-3-2



Power supply,  
1 AC, 24 V DC, 5 A

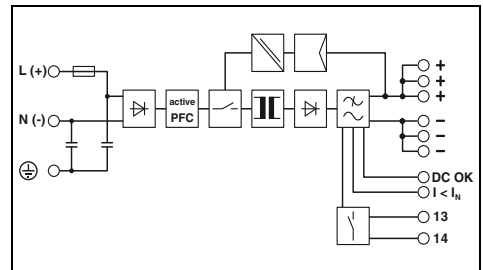

#### Technical data

Input data	
Nominal input voltage range	100 V AC ... 240 V AC
Input voltage range	85 V AC ... 264 V AC / 90 V DC ... 350 V DC
Frequency range	45 Hz ... 65 Hz / 0 Hz
Current consumption (nominal load)	1.2 A (120 V AC) / 0.6 A (230 V AC)
Inrush current limitation at 25°C (typ.) / I <sup>2</sup> t	< 15 A / < 1 A <sup>2</sup> s
Mains buffering (I <sub>N</sub> , typ.)	> 55 ms (120 V AC) / > 55 ms (230 V AC)
Output data	
Nominal output voltage	24 V DC ±1 %
Setting range of the output voltage	18 V DC ... 29.5 V DC (> 24 V constant capacity)
Output current / POWER BOOST / SFB (12 ms)	5 A / 7.5 A / 30 A
Magnetic fuse tripping	B2 / B4 / C2
Can be connected in parallel / series	Yes / Yes
Max. power dissipation (no load / nominal load)	3 W / 15 W
Efficiency (typ.)	> 90% (for 230 V AC and nominal values)
Residual ripple	< 40 mV <sub>pp</sub>
Signaling	
Signaling DC OK	LED, active switching output, relay contact
Boost signaling	LED, active switching output
General data	
Weight / Dimensions W x H x D	0.7 kg / 40 x 130 x 125 mm
Spacing when mounting	Alignable: 5 mm horizontally, 15 mm next to active components, 50 mm vertically
Connection method	Plug-in screw connection
Input connection data (solid / stranded / AWG)	0.2 - 2.5 mm <sup>2</sup> / 0.2 - 2.5 mm <sup>2</sup> / 20 - 12
Output connection data (solid / stranded / AWG)	0.2 - 2.5 mm <sup>2</sup> / 0.2 - 2.5 mm <sup>2</sup> / 20 - 12
Signal connection data (solid / stranded / AWG)	0.2 - 2.5 mm <sup>2</sup> / 0.2 - 2.5 mm <sup>2</sup> / 20 - 12
Degree of protection / Protection class	IP20 / I
MTBF (IEC 61709, SN 29500)	> 635000 h (40°C)
Ambient temperature (operation)	-25°C ... 70°C (> 60°C derating: 2.5%/K, startup at -40°C type-tested)
Standards/regulations	
Insulation voltage input/output	2 kV AC (routine test) / 4 kV AC (type test)
Electromagnetic compatibility	Conformance with EMC Directive 2004/108/EC
Electrical safety	IEC 60950-1/VDE 0805 (SELV)
Electronic equipm. for electrical power installations	EN 50178/VDE 0160 (PELV)
Safe isolation	DIN VDE 0100-410, DIN VDE 0106-1010
Medical standard	IEC 60601
UL approvals	UL Listed UL 508, UL/C-UL Recognized UL 60950-1, UL ANSI/ISA-12.12.01 Class I, Division 2, Groups A, B, C, D (Hazardous Location)
Limitation of harmonic line currents	EN 61000-3-2

#### Ordering data

Description	Type	Order No.	Pcs. / Pkt.
Power supply, primary-switched	QUINT-PS/1AC/24DC/3.5	2866747	1

#### Ordering data

Description	Type	Order No.	Pcs. / Pkt.
Power supply, primary-switched	QUINT-PS/1AC/24DC/5	2866750	1



Power supply,  
1 AC, 24 V DC, 10 A



Power supply,  
1 AC, 24 V DC, 20 A



Power supply,  
1 AC, 24 V DC, 40 A

UL, ENEC, ABS, BSH, ClassNK, CB, PSE  
Ex:

UL, ENEC, ABS, BSH, ClassNK, CB, PSE  
Ex:

UL, ENEC, ABS, BSH, ClassNK, CB, PSE  
Ex:

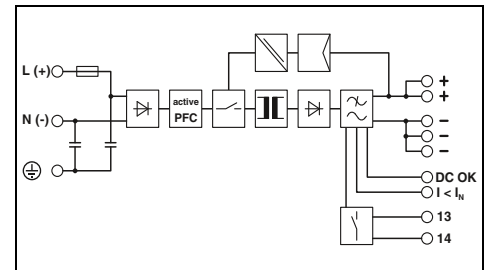
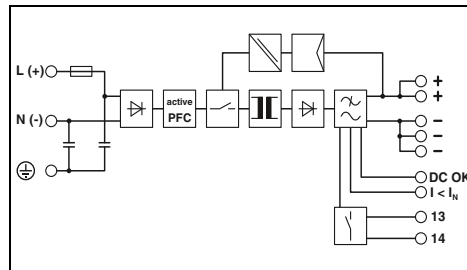
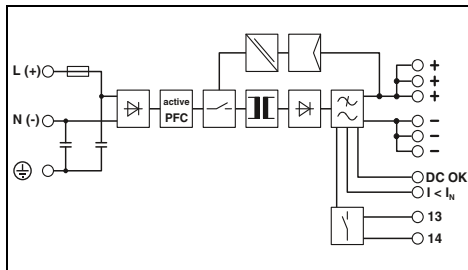

Technical data

100 V AC ... 240 V AC  
85 V AC ... 264 V AC / 90 V DC ... 350 V DC  
45 Hz ... 65 Hz / 0 Hz  
2.24 A (120 V AC) / 1.33 A (230 V AC)  
< 15 A / < 1.5 A<sup>2</sup>s  
> 36 ms (120 V AC) / > 36 ms (230 V AC)

24 V DC ±1 %  
18 V DC ... 29.5 V DC (> 24 V constant capacity)

10 A / 15 A / 60 A  
B2 / B4 / B6 / C2 / C4

Yes / Yes  
9.1 W / 22 W  
> 92.5% (for 230 V AC and nominal values)  
< 50 mV<sub>pp</sub>

LED, active switching output, relay contact  
LED, active switching output

1.1 kg / 60 x 130 x 125 mm  
Alignable: 5 mm horizontally, 15 mm next to active components,  
50 mm vertically  
Plug-in screw connection  
0.2 - 2.5 mm<sup>2</sup> / 0.2 - 2.5 mm<sup>2</sup> / 16 - 12  
0.2 - 2.5 mm<sup>2</sup> / 0.2 - 2.5 mm<sup>2</sup> / 16 - 12  
0.2 - 2.5 mm<sup>2</sup> / 0.2 - 2.5 mm<sup>2</sup> / 16 - 12  
IP20 / I  
> 535000 h (40°C)  
-25°C ... 70°C (> 60°C derating: 2.5%/K,  
startup at -40°C type-tested)

2 kV AC (routine test) / 4 kV AC (type test)  
Conformance with EMC Directive 2004/108/EC  
IEC 60950-1/VDE 0805 (SELV)  
EN 50178/VDE 0160 (PELV)  
DIN VDE 0100-410, DIN VDE 0106-1010  
IEC 60601  
UL Listed UL 508, UL/C-UL Recognized UL 60950-1,  
UL ANSI/ISA-12.12.01 Class I, Division 2, Groups A, B, C, D  
(Hazardous Location)  
EN 61000-3-2

Technical data

100 V AC ... 240 V AC  
85 V AC ... 264 V AC / 90 V DC ... 350 V DC  
45 Hz ... 65 Hz / 0 Hz  
5.1 A (120 V AC) / 2.3 A (230 V AC)  
< 20 A / < 3.2 A<sup>2</sup>s  
> 32 ms (120 V AC) / > 32 ms (230 V AC)

24 V DC ±1 %  
18 V DC ... 29.5 V DC (> 24 V constant capacity)

20 A / 26 A / 120 A  
B2 / B4 / B6 / B10 / B16 / C2 / C4 / C6

Yes / Yes  
8 W / 40 W  
> 93% (for 230 V AC and nominal values)  
< 30 mV<sub>pp</sub>

LED, active switching output, relay contact  
LED, active switching output

1.7 kg / 90 x 130 x 125 mm  
Alignable: 5 mm horizontally, 15 mm next to active components,  
50 mm vertically  
Screw connection  
0.2 - 6 mm<sup>2</sup> / 0.2 - 4 mm<sup>2</sup> / 18 - 10  
0.2 - 6 mm<sup>2</sup> / 0.2 - 4 mm<sup>2</sup> / 12 - 10  
0.2 - 6 mm<sup>2</sup> / 0.2 - 4 mm<sup>2</sup> / 18 - 10  
IP20 / I  
> 520000 h (40°C)  
-25°C ... 70°C (> 60°C derating: 2.5%/K,  
startup at -40°C type-tested)

2 kV AC (routine test) / 4 kV AC (type test)  
Conformance with EMC Directive 2004/108/EC  
IEC 60950-1/VDE 0805 (SELV)  
EN 50178/VDE 0160 (PELV)  
DIN VDE 0100-410, DIN VDE 0106-1010  
IEC 60601  
UL Listed UL 508, UL/C-UL Recognized UL 60950-1,  
UL ANSI/ISA-12.12.01 Class I, Division 2, Groups A, B, C, D  
(Hazardous Location)  
EN 61000-3-2

Technical data

100 V AC ... 240 V AC  
85 V AC ... 264 V AC / 90 V DC ... 300 V DC  
45 Hz ... 65 Hz / 0 Hz  
8.8 A (120 V AC) / 4.6 A (230 V AC)  
< 15 A / < 1.7 A<sup>2</sup>s  
> 20 ms (120 V AC) / > 20 ms (230 V AC)

24 V DC ±1 %  
18 V DC ... 29.5 V DC (> 24 V constant capacity)

40 A / 45 A / 215 A  
B2 / B4 / B6 / B10 / B16 / B25 / C2 / C4 / C6 / C13

Yes / Yes  
14 W / 80 W  
> 92% (for 230 V AC and nominal values)  
< 30 mV<sub>pp</sub>

LED, active switching output, relay contact  
LED, active switching output

3.3 kg / 180 x 130 x 125 mm  
Alignable: 5 mm horizontally, 15 mm next to active components,  
50 mm vertically  
Screw connection  
0.2 - 6 mm<sup>2</sup> / 0.2 - 4 mm<sup>2</sup> / 14 - 10  
0.5 - 16 mm<sup>2</sup> / 0.5 - 16 mm<sup>2</sup> / 8 - 6  
0.2 - 6 mm<sup>2</sup> / 0.2 - 4 mm<sup>2</sup> / 24 - 10  
IP20 / I  
> 530000 h (40°C)  
-25°C ... 70°C (> 60°C derating: 2.5%/K,  
startup at -40°C type-tested)

2 kV AC (routine test) / 4 kV AC (type test)  
Conformance with EMC Directive 2004/108/EC  
IEC 60950-1/VDE 0805 (SELV)  
EN 50178/VDE 0160 (PELV)  
DIN VDE 0100-410, DIN VDE 0106-1010  
-  
UL Listed UL 508, UL/C-UL Recognized UL 60950-1,  
UL ANSI/ISA-12.12.01 Class I, Division 2, Groups A, B, C, D  
(Hazardous Location)  
EN 61000-3-2

Ordering data

Type	Order No.	Pcs. / Pkt.
QUINT-PS/1AC/24DC/10	2866763	1

Ordering data

Type	Order No.	Pcs. / Pkt.
QUINT-PS/1AC/24DC/20	2866776	1

Ordering data

Type	Order No.	Pcs. / Pkt.
QUINT-PS/1AC/24DC/40	2866789	1

# Power supplies and UPS

## Power supply units

### QUINT POWER power supplies – maximum functionality

#### QUINT POWER, 3 AC, 24 V DC

- High system availability even in the event of a permanent phase failure
- High surge resistance of up to 6 kV thanks to integrated gas-filled arresters
- Quick tripping of standard circuit breakers thanks to the dynamic power reserve SFB (selective fuse breaking) technology with up to 6 times the nominal current for 12 ms
- Reliable starting of difficult loads with the static POWER BOOST power reserve with up to 1.5 times the nominal current permanently
- Preventive function monitoring warns against critical operating states before errors occur
- Flexible thanks to input voltage ranges for AC and DC voltages
- Approved for semiconductor production according to SEMI F47-0706



Power supply,  
3 AC, 24 V DC, 5 A

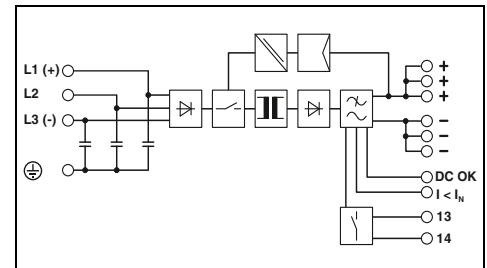

#### Technical data

<b>Input data</b>			
Nominal input voltage range	3x 400 V AC ... 500 V AC		
Input voltage range	3x 320 V AC ... 575 V AC / 2x 360 V AC ... 575 V AC / 450 V DC ... 800 V DC		
Frequency range	45 Hz ... 65 Hz / 0 Hz		
Current consumption (nominal load)	3x 0.8 A (400 V AC) / 3x 0.7 A (500 V AC)		
Inrush current limitation at 25°C (typ.) / I <sup>2</sup> t	< 15 A / < 1 A <sup>2</sup> s		
Mains buffering (I <sub>N</sub> , typ.)	> 20 ms (400 V AC) / > 30 ms (500 V AC)		
<b>Output data</b>			
Nominal output voltage	24 V DC ±1 %		
Setting range of the output voltage	18 V DC ... 29.5 V DC (> 24 V constant capacity)		
Output current / POWER BOOST / SFB (12 ms)	5 A / 7.5 A / 30 A		
Magnetic fuse tripping	B2 / B4 / C2		
Can be connected in parallel / series	Yes / Yes		
Max. power dissipation (no load / nominal load)	4 W / 14 W		
Efficiency (typ.)	> 89% (at 400 V AC and nominal values)		
Residual ripple	< 20 mV <sub>PP</sub>		
<b>Signaling</b>			
Signaling DC OK	LED, active switching output, relay contact		
Boost signaling	LED, active switching output		
<b>General data</b>			
Weight / Dimensions W x H x D	0.7 kg / 40 x 130 x 125 mm		
Spacing when mounting	Alignable: 5 mm horizontally, 15 mm next to active components, 50 mm vertically		
Connection method	Plug-in screw connection		
Input connection data (solid / stranded / AWG)	0.2 - 2.5 mm <sup>2</sup> / 0.2 - 2.5 mm <sup>2</sup> / 20 - 12		
Output connection data (solid / stranded / AWG)	0.2 - 2.5 mm <sup>2</sup> / 0.2 - 2.5 mm <sup>2</sup> / 20 - 12		
Signal connection data (solid / stranded / AWG)	0.2 - 2.5 mm <sup>2</sup> / 0.2 - 2.5 mm <sup>2</sup> / 20 - 12		
Degree of protection / Protection class	IP20 / I		
MTBF (IEC 61709, SN 29500)	> 635000 h (40°C)		
Ambient temperature (operation)	-25°C ... 70°C (> 60°C derating: 2.5%/K, startup at -40°C type-tested)		
<b>Standards/regulations</b>			
Insulation voltage input/output	2 kV AC (routine test) / 4 kV AC (type test)		
Electromagnetic compatibility	Conformance with EMC Directive 2004/108/EC		
Electrical safety	IEC 60950-1/VDE 0805 (SELV)		
Electronic equipm. for electrical power installations	EN 50178/VDE 0160 (PELV)		
Safe isolation	DIN VDE 0100-410, DIN VDE 0106-1010		
UL approvals	UL Listed UL 508, UL/C-UL Recognized UL 60950-1 (3-wire + PE, star net), UL ANSI/ISA-12.12.01 Class I, Division 2, Groups A, B, C, D (Hazardous Location)		
Limitation of harmonic line currents	EN 61000-3-2		
<b>Ordering data</b>			
<b>Description</b>	<b>Type</b>	<b>Order No.</b>	<b>Pcs. / Pkt.</b>
<b>Power supply, primary-switched</b>	QUINT-PS/3AC/24DC/ 5	2866734	1



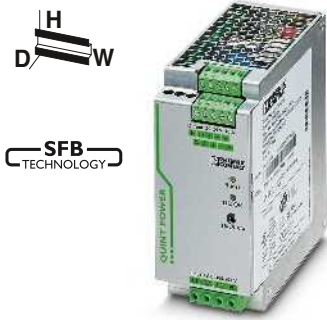

**Power supply,  
3 AC, 24 V DC, 10 A**



**Power supply,  
3 AC, 24 V DC, 20 A**



**Power supply,  
3 AC, 24 V DC, 40 A**

UL, ABS, BSH, ClassNK, CB, Ex

UL, ABS, BSH, ClassNK, CB, Ex

UL, ABS, BSH, ClassNK, CB, Ex

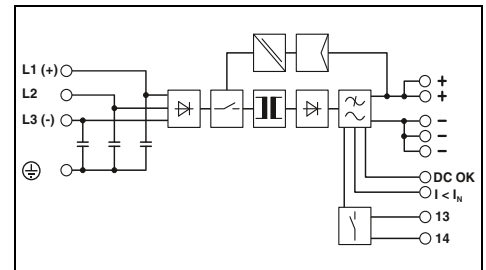
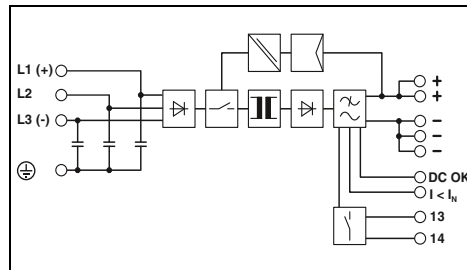
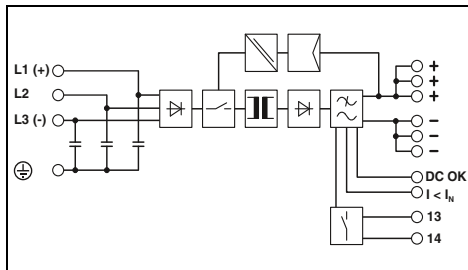

### Technical data

3x 400 V AC ... 500 V AC  
3x 320 V AC ... 575 V AC / 2x 360 V AC ... 575 V AC /  
450 V DC ... 800 V DC  
45 Hz ... 65 Hz / 0 Hz  
3x 1.2 A (400 V AC) / 3x 1 A (500 V AC)  
< 15 A / < 1.5 A<sup>2</sup>s  
> 20 ms (400 V AC) / > 30 ms (500 V AC)

24 V DC ±1 %  
18 V DC ... 29.5 V DC (> 24 V constant capacity)

10 A / 15 A / 60 A  
B2 / B4 / B6 / C2 / C4  
Yes / Yes  
7 W / 19 W  
> 93% (at 400 V AC and nominal values)  
< 20 mV<sub>pp</sub>

LED, active switching output, relay contact  
LED, active switching output

1.1 kg / 60 x 130 x 125 mm  
Alignable: 5 mm horizontally, 15 mm next to active components,  
50 mm vertically  
Plug-in screw connection  
0.2 - 2.5 mm<sup>2</sup> / 0.2 - 2.5 mm<sup>2</sup> / 16 - 12  
0.2 - 2.5 mm<sup>2</sup> / 0.2 - 2.5 mm<sup>2</sup> / 16 - 12  
0.2 - 2.5 mm<sup>2</sup> / 0.2 - 2.5 mm<sup>2</sup> / 16 - 12  
IP20 / I  
> 633000 h (40°C)  
-25°C ... 70°C (> 60°C derating: 2.5%/K,  
startup at -40°C type-tested)

2 kV AC (routine test) / 4 kV AC (type test)  
Conformance with EMC Directive 2004/108/EC  
IEC 60950-1/VDE 0805 (SELV)  
EN 50178/VDE 0160 (PELV)  
DIN VDE 0100-410, DIN VDE 0106-1010  
UL Listed UL 508, UL/C-UL Recognized UL 60950-1  
(3-wire + PE, star net), UL ANSI/ISA-12.12.01 Class I, Division 2,  
Groups A, B, C, D (Hazardous Location)

EN 61000-3-2

### Ordering data

Type	Order No.	Pcs. / Pkt.
QUINT-PS/3AC/24DC/10	2866705	1

### Technical data

3x 400 V AC ... 500 V AC  
3x 320 V AC ... 575 V AC / 2x 360 V AC ... 575 V AC /  
450 V DC ... 800 V DC  
45 Hz ... 65 Hz / 0 Hz  
3x 1.6 A (400 V AC) / 3x 1.3 A (500 V AC)  
< 20 A / < 3.2 A<sup>2</sup>s  
> 20 ms (400 V AC) / > 30 ms (500 V AC)

24 V DC ±1 %  
18 V DC ... 29.5 V DC (> 24 V constant capacity)

20 A / 26 A / 120 A  
B2 / B4 / B6 / B10 / B16 / C2 / C4 / C6  
Yes / Yes  
11 W / 40 W  
> 93% (at 400 V AC and nominal values)  
< 40 mV<sub>pp</sub>

LED, active switching output, relay contact  
LED, active switching output

1.5 kg / 69 x 130 x 125 mm  
Alignable: 5 mm horizontally, 15 mm next to active components,  
50 mm vertically  
Screw connection  
0.2 - 6 mm<sup>2</sup> / 0.2 - 4 mm<sup>2</sup> / 18 - 10  
0.2 - 6 mm<sup>2</sup> / 0.2 - 4 mm<sup>2</sup> / 12 - 10  
0.2 - 6 mm<sup>2</sup> / 0.2 - 4 mm<sup>2</sup> / 18 - 10  
IP20 / I  
> 534000 h (40°C)  
-25°C ... 70°C (> 60°C derating: 2.5%/K,  
startup at -40°C type-tested)

2 kV AC (routine test) / 4 kV AC (type test)  
Conformance with EMC Directive 2004/108/EC  
IEC 60950-1/VDE 0805 (SELV)  
EN 50178/VDE 0160 (PELV)  
DIN VDE 0100-410, DIN VDE 0106-1010  
UL Listed UL 508, UL/C-UL Recognized UL 60950-1  
(3-wire + PE, star net), UL ANSI/ISA-12.12.01 Class I, Division 2,  
Groups A, B, C, D (Hazardous Location)

EN 61000-3-2

### Ordering data

Type	Order No.	Pcs. / Pkt.
QUINT-PS/3AC/24DC/20	2866792	1

### Technical data

3x 400 V AC ... 500 V AC  
3x 320 V AC ... 575 V AC / 2x 360 V AC ... 575 V AC /  
450 V DC ... 800 V DC  
45 Hz ... 65 Hz / 0 Hz  
3x 2.1 A (400 V AC) / 3x 1.7 A (500 V AC)  
< 20 A / < 1 A<sup>2</sup>s  
> 25 ms (400 V AC) / > 35 ms (500 V AC)

24 V DC ±1 %  
18 V DC ... 29.5 V DC (> 24 V constant capacity)

40 A / 45 A / 215 A  
B2 / B4 / B6 / B10 / B16 / B25 / C2 / C4 / C6 / C13  
Yes / Yes  
18 W / 63 W  
> 94% (at 400 V AC and nominal values)  
< 40 mV<sub>pp</sub>

LED, active switching output, relay contact  
LED, active switching output

2.5 kg / 96 x 130 x 176 mm  
Alignable: 5 mm horizontally, 15 mm next to active components,  
50 mm vertically  
Screw connection  
0.2 - 6 mm<sup>2</sup> / 0.2 - 4 mm<sup>2</sup> / 18 - 10  
0.5 - 16 mm<sup>2</sup> / 0.5 - 16 mm<sup>2</sup> / 8 - 6  
0.2 - 6 mm<sup>2</sup> / 0.2 - 4 mm<sup>2</sup> / 18 - 10  
IP20 / I  
> 501000 h (40°C)  
-25°C ... 70°C (> 60°C derating: 2.5%/K,  
startup at -40°C type-tested)

2 kV AC (routine test) / 4 kV AC (type test)  
Conformance with EMC Directive 2004/108/EC  
IEC 60950-1/VDE 0805 (SELV)  
EN 50178/VDE 0160 (PELV)  
DIN VDE 0100-410, DIN VDE 0106-101  
UL Listed UL 508, UL/C-UL Recognized UL 60950-1  
(3-wire + PE, star net), UL ANSI/ISA-12.12.01 Class I, Division 2,  
Groups A, B, C, D (Hazardous Location)

EN 61000-3-2

### Ordering data

Type	Order No.	Pcs. / Pkt.
QUINT-PS/3AC/24DC/40	2866802	1

# Power supplies and UPS

## Power supply units

### QUINT POWER power supplies – maximum functionality

#### QUINT POWER, 1 AC, 12 and 48 V DC

- Quick tripping of the standard circuit breakers
- Reliable starting of difficult loads
- Preventive function monitoring
- Flexible thanks to input voltage ranges for AC and DC voltages
- Approved for semiconductor production according to SEMI F47-0706: 12 V DC and 48 V DC, 5 A and 10 A
- Adjustable output voltage of 5 to 18 V DC, or 30 to 56 V DC

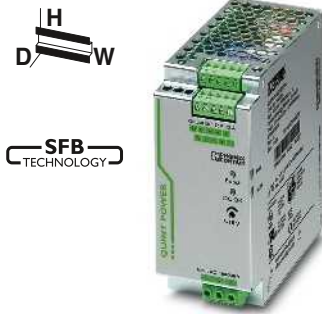

Power supply,  
1 AC, 12 V DC, 15 A

CE, UL, ENEC, CB, PSE  
Ex:



Power supply,  
1 AC, 12 V DC, 20 A

CE, UL, ENEC, CB, PSE  
Ex:

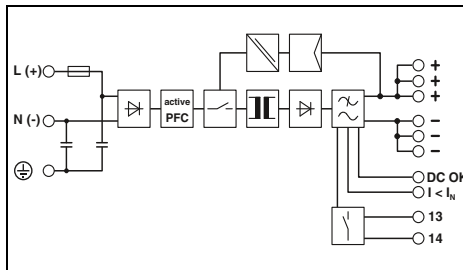

#### Technical data

Input data	
Nominal input voltage range	100 V AC ... 240 V AC
Input voltage range	85 V AC ... 264 V AC / 90 V DC ... 350 V DC
Frequency range	45 Hz ... 65 Hz / 0 Hz
Current consumption (nominal load)	1.9 A (120 V AC) / 0.9 A (230 V AC)
Inrush current limitation at 25°C (typ.) / I <sup>2</sup> t	< 15 A / < 1.5 A <sup>2</sup> s
Mains buffering (I <sub>N</sub> , typ.)	> 65 ms (120 V AC) / > 65 ms (230 V AC)
Output data	
Nominal output voltage	12 V DC ± 1 %
Setting range of the output voltage	5 V DC ... 18 V DC (> 12 V constant capacity)
Output current / POWER BOOST / SFB (12 ms)	15 A / 16 A / 60 A
Magnetic fuse tripping	B2 / B4 / B6 / C2 / C4
Can be connected in parallel / series	Yes / Yes
Max. power dissipation (no load / nominal load)	5 W / 21 W
Efficiency (typ.)	> 89% (for 230 V AC and nominal values)
Residual ripple	< 10 mV <sub>pp</sub>
Signaling	
Signaling DC OK	LED, active switching output, relay contact
Boost signaling	LED, active switching output
General data	
Weight / Dimensions W x H x D	1.1 kg / 60 x 130 x 125 mm
Spacing when mounting	Alignable: 5 mm horizontally, 15 mm next to active components, 50 mm vertically
Connection method	Plug-in screw connection
Input connection data (solid / stranded / AWG)	0.2 - 2.5 mm <sup>2</sup> / 0.2 - 2.5 mm <sup>2</sup> / 16 - 12
Output connection data (solid / stranded / AWG)	0.2 - 2.5 mm <sup>2</sup> / 0.2 - 2.5 mm <sup>2</sup> / 16 - 12
Signal connection data (solid / stranded / AWG)	0.2 - 2.5 mm <sup>2</sup> / 0.2 - 2.5 mm <sup>2</sup> / 16 - 12
Degree of protection / Protection class	IP20 / I
MTBF (IEC 61709, SN 29500)	> 570000 h (40°C)
Ambient temperature (operation)	-25°C ... 70°C (> 60°C derating: 2.5%/K, startup at -40°C type-tested)
Standards/regulations	
Insulation voltage input/output	2 kV AC (routine test) / 4 kV AC (type test)
Electromagnetic compatibility	Conformance with EMC Directive 2004/108/EC
Electrical safety	IEC 60950-1/VDE 0805 (SELV)
Electronic equipm. for electrical power installations	EN 50178/VDE 0160 (PELV)
Safe isolation	DIN VDE 0100-410, DIN VDE 0106-1010
Medical standard	IEC 60601
UL approvals	UL Listed UL 508, UL/C-UL Recognized UL 60950-1, UL ANSI/ISA-12.12.01 Class I, Division 2, Groups A, B, C, D (Hazardous Location)
Limitation of harmonic line currents	EN 61000-3-2

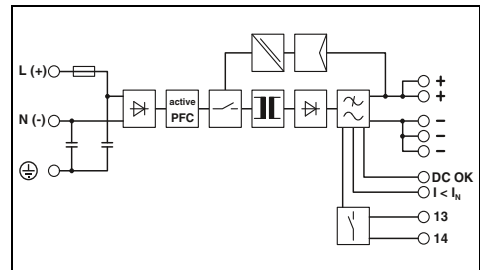

#### Technical data

Input data	
Nominal input voltage range	100 V AC ... 240 V AC
Input voltage range	85 V AC ... 264 V AC / 90 V DC ... 350 V DC
Frequency range	45 Hz ... 65 Hz / 0 Hz
Current consumption (nominal load)	2.4 A (120 V AC) / 1.4 A (230 V AC)
Inrush current limitation at 25°C (typ.) / I <sup>2</sup> t	< 20 A / < 3.2 A <sup>2</sup> s
Mains buffering (I <sub>N</sub> , typ.)	> 40 ms (120 V AC) / > 40 ms (230 V AC)
Output data	
Nominal output voltage	12 V DC ± 1 %
Setting range of the output voltage	5 V DC ... 18 V DC (> 12 V constant capacity)
Output current / POWER BOOST / SFB (12 ms)	20 A / 26 A / 120 A
Magnetic fuse tripping	B2 / B4 / B6 / B10 / C2 / C4 / C6
Can be connected in parallel / series	Yes / Yes
Max. power dissipation (no load / nominal load)	6 W / 29 W
Efficiency (typ.)	> 90% (for 230 V AC and nominal values)
Residual ripple	< 50 mV <sub>pp</sub>
Signaling	
Signaling DC OK	LED, active switching output, relay contact
Boost signaling	LED, active switching output
General data	
Weight / Dimensions W x H x D	1.5 kg / 90 x 130 x 125 mm
Spacing when mounting	Alignable: 5 mm horizontally, 15 mm next to active components, 50 mm vertically
Connection method	Screw connection
Input connection data (solid / stranded / AWG)	0.2 - 6 mm <sup>2</sup> / 0.2 - 4 mm <sup>2</sup> / 18 - 10
Output connection data (solid / stranded / AWG)	0.2 - 6 mm <sup>2</sup> / 0.2 - 4 mm <sup>2</sup> / 18 - 10
Signal connection data (solid / stranded / AWG)	0.2 - 6 mm <sup>2</sup> / 0.2 - 4 mm <sup>2</sup> / 18 - 10
Degree of protection / Protection class	IP20 / I
MTBF (IEC 61709, SN 29500)	> 600000 h (40°C)
Ambient temperature (operation)	-25°C ... 70°C (> 60°C derating: 2.5%/K, startup at -40°C type-tested)
Standards/regulations	
Insulation voltage input/output	2 kV AC (routine test) / 4 kV AC (type test)
Electromagnetic compatibility	Conformance with EMC Directive 2004/108/EC
Electrical safety	IEC 60950-1/VDE 0805 (SELV)
Electronic equipm. for electrical power installations	EN 50178/VDE 0160 (PELV)
Safe isolation	DIN VDE 0100-410, DIN VDE 0106-1010
Medical standard	IEC 60601
UL approvals	UL Listed UL 508, UL/C-UL Recognized UL 60950-1, UL ANSI/ISA-12.12.01 Class I, Division 2, Groups A, B, C, D (Hazardous Location)
Limitation of harmonic line currents	EN 61000-3-2

#### Ordering data

Description	Type	Order No.	Pcs. / Pkt.
Power supply, primary-switched	QUINT-PS/1AC/12DC/15	2866718	1

#### Ordering data

Description	Type	Order No.	Pcs. / Pkt.
Power supply, primary-switched	QUINT-PS/1AC/12DC/20	2866721	1

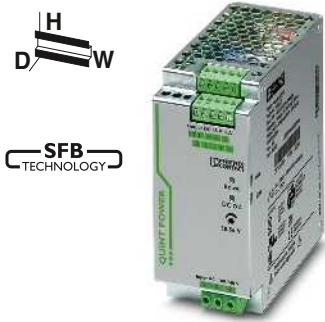

Power supply,  
1 AC, 48 V DC, 5 A



Power supply,  
1 AC, 48 V DC, 10 A



Power supply,  
1 AC, 48 V DC, 20 A

UL ENEC CB PSE  
Ex:

UL ENEC CB PSE  
Ex:

UL ENEC CB PSE  
Ex:

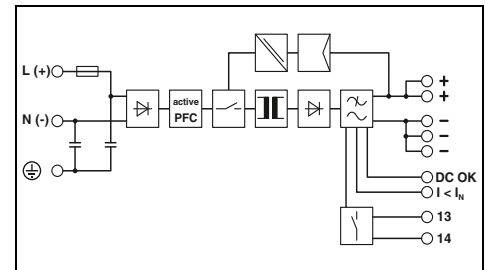
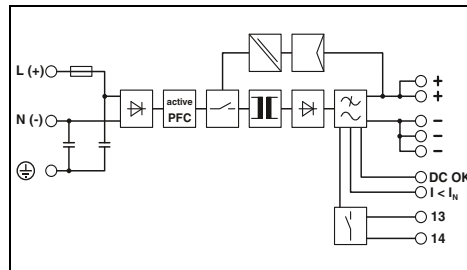
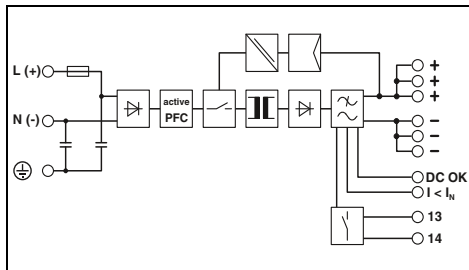

Technical data

Technical data

Technical data

100 V AC ... 240 V AC  
85 V AC ... 264 V AC / 90 V DC ... 350 V DC  
45 Hz ... 65 Hz / 0 Hz  
2.8 A (120 V AC) / 1.2 A (230 V AC)  
< 15 A / < 1.5 A<sup>2</sup>s  
> 40 ms (120 V AC) / > 40 ms (230 V AC)

100 V AC ... 240 V AC  
85 V AC ... 264 V AC / 90 V DC ... 350 V DC  
45 Hz ... 65 Hz / 0 Hz  
5.1 A (120 V AC) / 2.3 A (230 V AC)  
< 20 A / < 3.2 A<sup>2</sup>s  
> 20 ms (120 V AC) / > 20 ms (230 V AC)

100 V AC ... 240 V AC  
85 V AC ... 264 V AC / 90 V DC ... 300 V DC  
45 Hz ... 65 Hz / 0 Hz  
8.7 A (120 V AC) / 4.5 A (230 V AC)  
< 15 A / < 1.6 A<sup>2</sup>s  
> 25 ms (120 V AC) / > 25 ms (230 V AC)

48 V DC ±1 %  
30 V DC ... 56 V DC (> 48 V constant capacity)

48 V DC ±1 %  
30 V DC ... 56 V DC (> 48 V constant capacity)

48 V DC ±1 %  
30 V DC ... 56 V DC (> 48 V constant capacity)

5 A / 7.5 A / 30 A  
B2 / B4 / C2  
Yes / Yes  
7 W / 21 W  
> 92.5% (for 230 V AC and nominal values)  
< 50 mV<sub>pp</sub>

10 A / 13 A / 60 A  
B2 / B4 / B6 / C2 / C4  
Yes / Yes  
16 W / 41 W  
> 93% (for 230 V AC and nominal values)  
< 80 mV<sub>pp</sub>

20 A / 22.5 A / 100 A  
B2 / B4 / B6 / B10 / C2 / C4 / C6  
Yes / Yes  
12 W / 74 W  
> 93% (for 230 V AC and nominal values)  
< 50 mV<sub>pp</sub>

LED, active switching output, relay contact  
LED, active switching output

LED, active switching output, relay contact  
LED, active switching output

LED, active switching output, relay contact  
LED, active switching output

1.1 kg / 60 x 130 x 125 mm  
Alignable: 5 mm horizontally, 15 mm next to active components, 50 mm vertically  
Plug-in screw connection  
0.2 - 2.5 mm<sup>2</sup> / 0.2 - 2.5 mm<sup>2</sup> / 16 - 12  
0.2 - 2.5 mm<sup>2</sup> / 0.2 - 2.5 mm<sup>2</sup> / 16 - 12  
0.2 - 2.5 mm<sup>2</sup> / 0.2 - 2.5 mm<sup>2</sup> / 16 - 12  
IP20 / I  
> 535000 h (40°C)  
-25°C ... 70°C (> 60°C derating: 2.5%/K, startup at -40°C type-tested)

1.7 kg / 90 x 130 x 125 mm  
Alignable: 5 mm horizontally, 15 mm next to active components, 50 mm vertically  
Screw connection  
0.2 - 6 mm<sup>2</sup> / 0.2 - 4 mm<sup>2</sup> / 18 - 10  
0.2 - 6 mm<sup>2</sup> / 0.2 - 4 mm<sup>2</sup> / 12 - 10  
0.2 - 6 mm<sup>2</sup> / 0.2 - 4 mm<sup>2</sup> / 18 - 10  
IP20 / I  
> 630000 h (40°C)  
-25°C ... 70°C (> 60°C derating: 2.5%/K, startup at -40°C type-tested)

3.3 kg / 180 x 130 x 125 mm  
Alignable: 5 mm horizontally, 15 mm next to active components, 50 mm vertically  
Screw connection  
0.2 - 6 mm<sup>2</sup> / 0.2 - 4 mm<sup>2</sup> / 14 - 10  
0.5 - 16 mm<sup>2</sup> / 0.5 - 16 mm<sup>2</sup> / 8 - 6  
0.2 - 6 mm<sup>2</sup> / 0.2 - 4 mm<sup>2</sup> / 24 - 10  
IP20 / I  
> 523000 h (40°C)  
-25°C ... 70°C (> 60°C derating: 2.5%/K, startup at -40°C type-tested)

2 kV AC (routine test) / 4 kV AC (type test)  
Conformance with EMC Directive 2004/108/EC  
IEC 60950-1/VDE 0805 (SELV)  
EN 50178/VDE 0160 (PELV)  
DIN VDE 0100-410, DIN VDE 0106-1010  
IEC 60601  
UL Listed UL 508, UL/C-UL Recognized UL 60950-1,  
UL ANSI/ISA-12.12.01 Class I, Division 2, Groups A, B, C, D  
(Hazardous Location)  
EN 61000-3-2

2 kV AC (routine test) / 4 kV AC (type test)  
Conformance with EMC Directive 2004/108/EC  
IEC 60950-1/VDE 0805 (SELV)  
EN 50178/VDE 0160 (PELV)  
DIN VDE 0100-410, DIN VDE 0106-1010  
IEC 60601  
UL Listed UL 508, UL/C-UL Recognized UL 60950-1,  
UL ANSI/ISA-12.12.01 Class I, Division 2, Groups A, B, C, D  
(Hazardous Location)  
EN 61000-3-2

2 kV AC (routine test) / 4 kV AC (type test)  
Conformance with EMC Directive 2004/108/EC  
IEC 60950-1/VDE 0805 (SELV)  
EN 50178/VDE 0160 (PELV)  
DIN VDE 0100-410, DIN VDE 0106-1010  
-  
UL Listed UL 508, UL/C-UL Recognized UL 60950-1,  
UL ANSI/ISA-12.12.01 Class I, Division 2, Groups A, B, C, D  
(Hazardous Location)  
EN 61000-3-2

Ordering data

Ordering data

Ordering data

Type	Order No.	Pcs. / Pkt.
QUINT-PS/1AC/48DC/5	2866679	1

Type	Order No.	Pcs. / Pkt.
QUINT-PS/1AC/48DC/10	2866682	1

Type	Order No.	Pcs. / Pkt.
QUINT-PS/1AC/48DC/20	2866695	1

# Power supplies and UPS

## Power supply units

### QUINT POWER power supplies – maximum functionality

#### QUINT POWER, 3 AC, 48 V DC

- High system availability even in the event of a permanent phase failure
- High surge resistance of up to 6 kV thanks to integrated gas-filled arresters
- Quick tripping of standard circuit breakers thanks to the dynamic power reserve SFB (selective fuse breaking) technology with up to 6 times the nominal current for 12 ms
- Reliable starting of difficult loads with the static POWER BOOST power reserve with up to 1.5 times the nominal current permanently
- Preventive function monitoring warns against critical operating states before errors occur
- Flexible thanks to input voltage ranges for AC and DC voltages
- Adjustable output voltage of 30 to 56 V DC



Power supply,  
3 AC, 48 V DC, 20 A

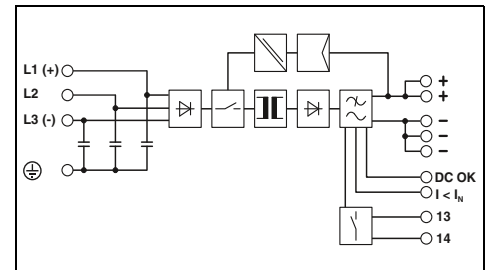

#### Technical data

<b>Input data</b>							
Nominal input voltage range	3x 400 V AC ... 500 V AC						
Input voltage range	3x 320 V AC ... 575 V AC / 2x 360 V AC ... 575 V AC / 450 V DC ... 800 V DC						
Frequency range	45 Hz ... 65 Hz / 0 Hz						
Current consumption (nominal load)	3x 2.1 A (400 V AC) / 3x 1.7 A (500 V AC)						
Inrush current limitation at 25°C (typ.) / I <sup>2</sup> t	< 20 A / < 1 A <sup>2</sup> s						
Mains buffering (I <sub>N</sub> , typ.)	> 25 ms (400 V AC) / > 35 ms (500 V AC)						
<b>Output data</b>							
Nominal output voltage	48 V DC ±1 %						
Setting range of the output voltage	30 V DC ... 56 V DC (> 48 V constant capacity)						
Output current / POWER BOOST / SFB (12 ms)	20 A / 22.5 A / 100 A						
Magnetic fuse tripping	B2 / B4 / B6 / B10 / C2 / C4 / C6						
Can be connected in parallel / series	Yes / Yes						
Max. power dissipation (no load / nominal load)	24 W / 70 W						
Efficiency (typ.)	> 93% (at 400 V AC and nominal values)						
Residual ripple	< 50 mV <sub>pp</sub>						
<b>Signaling</b>							
Signaling DC OK	LED, active switching output, relay contact						
Boost signaling	LED, active switching output						
<b>General data</b>							
Weight / Dimensions W x H x D	2.5 kg / 96 x 130 x 176 mm						
Spacing when mounting	Alignable: 5 mm horizontally, 15 mm next to active components, 50 mm vertically						
Connection method	Screw connection						
Input connection data (solid / stranded / AWG)	0.2 - 6 mm <sup>2</sup> / 0.2 - 4 mm <sup>2</sup> / 18 - 10						
Output connection data (solid / stranded / AWG)	0.5 - 16 mm <sup>2</sup> / 0.5 - 16 mm <sup>2</sup> / 8 - 6						
Signal connection data (solid / stranded / AWG)	0.2 - 6 mm <sup>2</sup> / 0.2 - 4 mm <sup>2</sup> / 18 - 10						
Degree of protection / Protection class	IP20 / I						
MTBF (IEC 61709, SN 29500)	> 509000 h (40°C)						
Ambient temperature (operation)	-25°C ... 70°C (> 60°C derating: 2.5%/K, startup at -40°C type-tested)						
<b>Standards/regulations</b>							
Insulation voltage input/output	2 kV AC (routine test) / 4 kV AC (type test)						
Electromagnetic compatibility	Conformance with EMC Directive 2004/108/EC						
Electrical safety	IEC 60950-1/VDE 0805 (SELV)						
Electronic equipm. for electrical power installations	EN 50178/VDE 0160 (PELV)						
Safe isolation	DIN VDE 0100-410, DIN VDE 0106-1010						
UL approvals	UL Listed UL 508, UL/C-UL Recognized UL 60950-1 (3-wire + PE, star net), UL ANSI/ISA-12.12.01 Class I, Division 2, Groups A, B, C, D (Hazardous Location)						
Limitation of harmonic line currents	EN 61000-3-2						
<b>Description</b>	<b>Ordering data</b>						
<b>Power supply, primary-switched</b>	<table border="1"> <thead> <tr> <th>Type</th> <th>Order No.</th> <th>Pcs. / Pkt.</th> </tr> </thead> <tbody> <tr> <td>QUINT-PS/3AC/48DC/20</td> <td>2320827</td> <td>1</td> </tr> </tbody> </table>	Type	Order No.	Pcs. / Pkt.	QUINT-PS/3AC/48DC/20	2320827	1
Type	Order No.	Pcs. / Pkt.					
QUINT-PS/3AC/48DC/20	2320827	1					

**QUINT POWER power supplies – maximum functionality**

**QUINT POWER for frequency inverters**

- In the event of mains failure, the DC intermediate circuit voltage of the inverter continues to supply all connected 24 V loads without interruption
- Maintenance-free buffer solution: controlled machine stop in the event of mains failure by using the existing capacity in the frequency inverter or by using the kinetic energy of motors
- Compact solution in one housing: parallel operation on 2-phase AC mains and a DC intermediate circuit
- Fast tripping of standard circuit breakers with dynamic power reserve SFB (selective fuse breaking) technology with up to 6 times the nominal current for 20 ms
- Reliably start difficult loads with the static POWER BOOST power reserve
- Preventive function monitoring warns against critical operating states before errors occur



**Power supply with two separate input circuits for frequency inverters  
2 AC, 1 DC/24 V DC, 20 A**

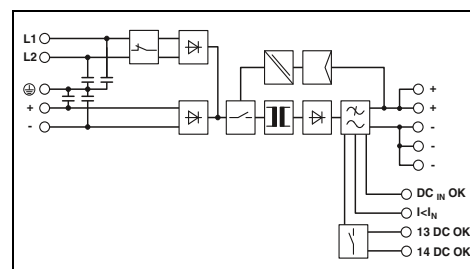

**Technical data**

<b>Input data of AC</b>	2x 400 V AC ... 500 V AC 2x 360 V AC ... 575 V AC / 450 V DC ... 840 V DC 45 Hz ... 65 Hz 2.5 A (400 V AC) / 2.1 A (500 V AC) < 85 A / < 1.5 A <sup>2</sup> s > 20 ms (400 V AC)
<b>Input data of DC</b>	600 V DC 450 V DC ... 840 V DC approx. 0.9 A (600 V DC)
<b>Output data</b>	24 V DC ±1 % 18 V DC ... 29.5 V DC (U <sub>IN</sub> ≥ 360 V AC / 480 V DC) 18 V DC ... 26 V DC (< 480 V DC) 20 A / 26 A / 120 A C6 / B16 11 W / 51 W > 92% (600 V DC) < 50 mV <sub>pp</sub>
<b>Signaling</b>	LED, relay contact LED, active switching output LED, active switching output
<b>General data</b>	2 kg / 120 x 130 x 125 mm Alignable: 5 mm horizontally, 15 mm next to active components, 50 mm vertically Screw connection 0.2 - 6 mm <sup>2</sup> / 0.2 - 4 mm <sup>2</sup> / 24 - 10 0.2 - 6 mm <sup>2</sup> / 0.2 - 4 mm <sup>2</sup> / 12 - 10 0.2 - 6 mm <sup>2</sup> / 0.2 - 4 mm <sup>2</sup> / 24 - 10 IP20 / I > 860000 h (40°C) -25°C ... 70°C (> 60°C derating: 2.5%/K)
<b>Standards/regulations</b>	2 kV AC (routine test) / 1.5 kV AC (type test)
<b>Electromagnetic compatibility</b>	Conformance with EMC Directive 2004/108/EC EN 60950-1/VDE 0805 (SELV) EN 50178/VDE 0160 (PELV) DIN VDE 0100-410 UL/C-UL listed UL 508, UL/C-UL Recognized UL 60950-1

**Ordering data**

Description	Type	Order No.	Pcs. / Pkt.
<b>Power supply, primary-switched</b>	<b>QUINT-PS/2AC/1DC/24DC/20</b>	<b>2320830</b>	<b>1</b>

# Power supplies and UPS

## Power supply units

### Power supplies for extreme requirements

#### QUINT POWER with protective coating

The protective coating protects against extreme ambient conditions, such as dust, pollution, corrosive gases, and 100% humidity

- Devices with ATEX approval conform to standard EN 60079-15 and EN 60079-0 and may be installed in a potentially explosive area (zone 2)
- They are suitable for use in Class I, Division 2, Groups A, B, C, D
- Conformance with railway standard EN 50155
- OVP (Over Voltage Protection) limits surge voltages to 32 V
- Wide temperature range from -40°C to +70°C
- Quick tripping of standard circuit breakers thanks to the dynamic power reserve SFB (selective fuse breaking) technology with up to 6 times the nominal current for 12 ms
- Reliable starting of difficult loads with the static POWER BOOST power reserve with up to 1.5 times the nominal current permanently
- Preventive function monitoring warns against critical operating states before errors occur
- Flexible thanks to input voltage ranges for AC and DC voltages



**Power supply, with protective coating, 1 AC, 24 V DC, 5 A**

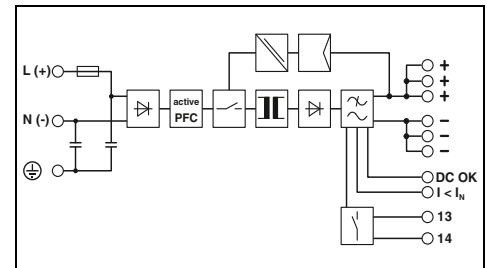

#### Technical data

<b>Input data</b>	100 V AC ... 240 V AC 85 V AC ... 264 V AC / 90 V DC ... 410 V DC
Nominal input voltage range	
Input voltage range	
Frequency range	45 Hz ... 65 Hz / 0 Hz
Current consumption (nominal load)	1.2 A (120 V AC) / 0.6 A (230 V AC)
Inrush current limitation at 25°C (typ.) / I <sup>2</sup> t	< 15 A / < 1 A <sup>2</sup> s
Mains buffering (I <sub>N</sub> , typ.)	> 25 ms (120 V AC) / > 25 ms (230 V AC)
<b>Output data</b>	
Nominal output voltage	24 V DC ±1 %
Setting range of the output voltage	18 V DC ... 29.5 V DC (> 24 V constant capacity)
Output current / POWER BOOST / SFB (12 ms)	5 A / 7.5 A / 30 A
Magnetic fuse tripping	B2 / B4 / C2
Can be connected in parallel / series	Yes / Yes
Max. power dissipation (no load / nominal load)	< 3 W / < 15 W
Efficiency (typ.)	> 90% (for 230 V AC and nominal values)
Residual ripple	< 40 mV <sub>pp</sub>
<b>Signaling</b>	
Signaling DC OK	LED, active switching output, relay contact
Boost signaling	LED, active switching output
<b>General data</b>	
Weight / Dimensions W x H x D	0.7 kg / 40 x 130 x 125 mm
Spacing when mounting	Alignable: 5 mm horizontally, 15 mm next to active components, 50 mm vertically
Connection method	Plug-in screw connection
Input connection data (solid / stranded / AWG)	0.2 - 2.5 mm <sup>2</sup> / 0.2 - 2.5 mm <sup>2</sup> / 20 - 12
Output connection data (solid / stranded / AWG)	0.2 - 2.5 mm <sup>2</sup> / 0.2 - 2.5 mm <sup>2</sup> / 20 - 12
Signal connection data (solid / stranded / AWG)	0.2 - 2.5 mm <sup>2</sup> / 0.2 - 2.5 mm <sup>2</sup> / 20 - 12
Degree of protection / Protection class	IP20 / I
MTBF (IEC 61709, SN 29500)	> 635000 h (40°C)
Ambient temperature (operation)	-40°C ... 70°C (> 60°C derating: 2.5%/K)
<b>Standards/regulations</b>	
Insulation voltage input/output	2 kV AC (routine test) / 4 kV AC (type test)
Electromagnetic compatibility	Conformance with EMC Directive 2004/108/EC
Electrical safety	IEC 60950-1/VDE 0805 (SELV)
Electronic equipm. for electrical power installations	EN 50178/VDE 0160 (PELV)
Safe isolation	DIN VDE 0100-410, DIN VDE 0106-1010
Rail applications	EN 50121-4 / EN 50155
UL approvals	UL/C-UL listed UL 508, UL/C-UL Recognized UL 60950, UL ANSI/ISA-12.12.01 Class I, Division 2, Groups A, B, C, D (Hazardous Location)
Limitation of harmonic line currents	EN 61000-3-2

#### Ordering data

Description	Type	Order No.	Pcs. / Pkt.
<b>Power supply, primary-switched</b>	QUINT-PS/1AC/24DC/5/CO	2320908	1



Power supply,  
with protective coating,  
1 AC, 24 V DC, 10 A

UL, ENEC, EAC, ABS, ClassNK, CB  
Ex: Ex



Power supply,  
with protective coating,  
1 AC, 24 V DC, 20 A

UL, ENEC, EAC, ClassNK, CB  
Ex: Ex



Power supply,  
with protective coating,  
3 AC, 24 V DC, 20 A

UL, ENEC, EAC, ClassNK, CB  
Ex: Ex

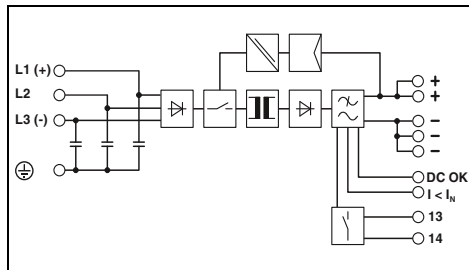
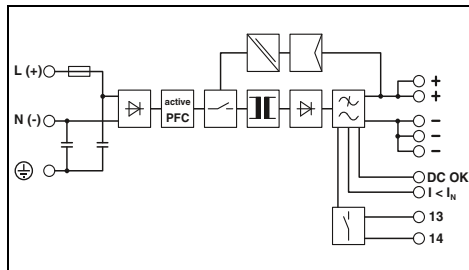
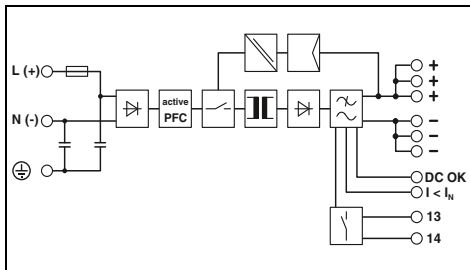

Technical data

Technical data

Technical data

100 V AC ... 240 V AC  
85 V AC ... 264 V AC / 90 V DC ... 410 V DC

45 Hz ... 65 Hz / 0 Hz  
2.24 A (120 V AC) / 1.33 A (230 V AC)  
< 15 A / < 1.5 A<sup>2</sup>s  
> 27 ms (120 V AC) / > 31 ms (230 V AC)

24 V DC ±1 %  
18 V DC ... 29.5 V DC (> 24 V constant capacity)

10 A / 15 A / 60 A  
B2 / B4 / B6 / C2 / C4  
Yes / Yes  
9.1 W / 22 W  
> 92.5% (for 230 V AC and nominal values)  
< 50 mV<sub>pp</sub>

LED, active switching output, relay contact  
LED, active switching output

1.1 kg / 60 x 130 x 125 mm  
Alignable: 5 mm horizontally, 15 mm next to active components,  
50 mm vertically  
Plug-in screw connection  
0.2 - 2.5 mm<sup>2</sup> / 0.2 - 2.5 mm<sup>2</sup> / 16 - 12  
0.2 - 2.5 mm<sup>2</sup> / 0.2 - 2.5 mm<sup>2</sup> / 16 - 12  
0.2 - 2.5 mm<sup>2</sup> / 0.2 - 2.5 mm<sup>2</sup> / 16 - 12  
IP20 / I  
> 535000 h (40°C)  
-40°C ... 70°C (> 60°C derating: 2.5%/K)

2 kV AC (routine test) / 4 kV AC (type test)  
Conformance with EMC Directive 2004/108/EC  
IEC 60950-1/VDE 0805 (SELV)  
EN 50178/VDE 0160 (PELV)  
DIN VDE 0100-410, DIN VDE 0106-1010  
EN 50121-4 / EN 50155  
UL/C-UL listed UL 508, UL/C-UL Recognized UL 60950,  
UL ANSI/ISA-12.12.01 Class I, Division 2, Groups A, B, C, D  
(Hazardous Location)

EN 61000-3-2

100 V AC ... 240 V AC  
85 V AC ... 264 V AC / 90 V DC ... 410 V DC

45 Hz ... 65 Hz / 0 Hz  
4.5 A (120 V AC) / 2.5 A (230 V AC)  
< 20 A / < 3.2 A<sup>2</sup>s  
> 20 ms (120 V AC) / > 20 ms (230 V AC)

24 V DC ±1 %  
18 V DC ... 29.5 V DC (> 24 V constant capacity)

20 A / 26 A / 120 A  
B2 / B4 / B6 / B10 / B16 / C2 / C4 / C6  
Yes / Yes  
8 W / 40 W  
> 93% (for 230 V AC and nominal values)  
< 30 mV<sub>pp</sub>

LED, active switching output, relay contact  
LED, active switching output

1.7 kg / 90 x 130 x 125 mm  
Alignable: 5 mm horizontally, 15 mm next to active components,  
50 mm vertically  
Screw connection  
0.2 - 6 mm<sup>2</sup> / 0.2 - 4 mm<sup>2</sup> / 18 - 10  
0.2 - 6 mm<sup>2</sup> / 0.2 - 4 mm<sup>2</sup> / 12 - 10  
0.2 - 6 mm<sup>2</sup> / 0.2 - 4 mm<sup>2</sup> / 18 - 10  
IP20 / I  
> 520000 h (40°C)  
-40°C ... 70°C (> 60°C derating: 2.5%/K)

2 kV AC (routine test) / 4 kV AC (type test)  
Conformance with EMC Directive 2004/108/EC  
IEC 60950-1/VDE 0805 (SELV)  
EN 50178/VDE 0160 (PELV)  
DIN VDE 0100-410, DIN VDE 0106-1010  
EN 50121-4 / EN 50155  
UL/C-UL listed UL 508, UL/C-UL Recognized UL 60950,  
UL ANSI/ISA-12.12.01 Class I, Division 2, Groups A, B, C, D  
(Hazardous Location)

EN 61000-3-2

3x 400 V AC ... 500 V AC  
3x 320 V AC ... 575 V AC / 450 V DC ... 800 V DC

45 Hz ... 65 Hz / 0 Hz  
3x 1.6 A (400 V AC) / 3x 1.3 A (500 V AC)  
< 20 A / < 3.2 A<sup>2</sup>s  
> 15 ms (400 V AC) / > 25 ms (500 V AC)

24 V DC ±1 %  
18 V DC ... 29.5 V DC (> 24 V constant capacity)

20 A / 26 A / 120 A  
B2 / B4 / B6 / B10 / B16 / C2 / C4 / C6  
Yes / Yes  
11 W / 40 W  
> 93% (at 400 V AC and nominal values)  
< 40 mV<sub>pp</sub>

LED, active switching output, relay contact  
LED, active switching output

1.5 kg / 69 x 130 x 125 mm  
Alignable: 5 mm horizontally, 15 mm next to active components,  
50 mm vertically  
Screw connection  
0.2 - 6 mm<sup>2</sup> / 0.2 - 4 mm<sup>2</sup> / 18 - 10  
0.2 - 6 mm<sup>2</sup> / 0.2 - 4 mm<sup>2</sup> / 12 - 10  
0.2 - 6 mm<sup>2</sup> / 0.2 - 4 mm<sup>2</sup> / 18 - 10  
IP20 / I  
> 534000 h (40°C)  
-40°C ... 70°C (> 60°C derating: 2.5%/K)

2 kV AC (routine test) / 4 kV AC (type test)  
Conformance with EMC Directive 2004/108/EC  
IEC 60950-1/VDE 0805 (SELV)  
EN 50178/VDE 0160 (PELV)  
DIN VDE 0100-410, DIN VDE 0106-1010  
EN 50121-4 / EN 50155  
UL/C-UL listed UL 508, UL/C-UL Recognized UL 60950-1  
(3-wire + PE, star net), UL ANSI/ISA-12.12.01 Class I, Division 2,  
Groups A, B, C, D (Hazardous Location)

EN 61000-3-2

Ordering data

Ordering data

Ordering data

Type	Order No.	Pcs. / Pkt.
QUINT-PS/1AC/24DC/10/CO	2320911	1

Type	Order No.	Pcs. / Pkt.
QUINT-PS/1AC/24DC/20/CO	2320898	1

Type	Order No.	Pcs. / Pkt.
QUINT-PS/3AC/24DC/20/CO	2320924	1

# Power supplies and UPS

## Power supply units

### TRIO POWER power supplies – robust standard functionality

#### TRIO POWER 1 AC, 24 V DC, with push-in connection technology

- High operational reliability thanks to the robust design
- Wide temperature range from -25°C to +70°C as well as device startup at -40°C (type-tested)
- Reliable starting of dynamic loads with the dynamic boost, which supplies up to 1.5 times the nominal current for 5 seconds
- Time savings during installation thanks to the use of tool-free push-in connection technology
- Space savings in the control cabinet thanks to the narrow design
- Active function monitoring with DC OK LED and relay contact
- Input voltage range for DC voltage of 110 ... 250 V DC
- Third negative terminal block for grounding on the secondary side
- Maximum availability thanks to high MTBF (mean time between failure)
- Compensation of voltage drops by means of output voltage that can be set on the front

#### TRIO POWER, NEC Class 2

Output power limited to 100 W

- Specifically for applications that require certification according to UL 1310/508 Listed Class 2



new

Power supply,  
1 AC, 24 V DC, 3 A  
NEC Class 2

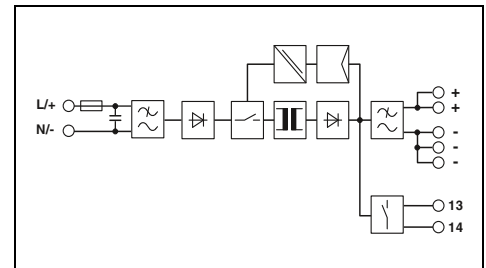

#### Technical data

<b>Input data</b>	100 V AC ... 240 V AC 85 V AC ... 264 V AC / 99 V DC ... 275 V DC 50 Hz ... 60 Hz 1.4 A (100 V AC) / 0.7 A (240 V AC) ≤ 15 A / < 0.26 A <sup>2</sup> s > 10 ms (120 V AC) / > 20 ms (230 V AC)
<b>Output data</b>	24 V DC ±1 % 24 V DC ... 28 V DC (> 24 V constant capacity)
<b>Output current / Dynamic BOOST (5 s)</b> Can be connected in parallel / series Max. power dissipation (no load / nominal load) Efficiency (typ.) Residual ripple	3 A / - Yes, with redundancy module / Yes < 1 W / < 10 W > 89% (for 230 V AC and nominal values) ≤ 50 mV <sub>pp</sub>
<b>Signaling</b>	LED, floating signal contact
<b>General data</b>	0.35 kg / 30 x 130 x 115 mm Alignable: horizontally 0 mm (≤ 40°C) 10 mm (≤ 70°C), vertically 50 mm Push-in connection 0.2 - 4 mm <sup>2</sup> / 0.2 - 2.5 mm <sup>2</sup> / 24 - 12 0.2 - 4 mm <sup>2</sup> / 0.2 - 2.5 mm <sup>2</sup> / 24 - 12 IP20 / II > 2000000 h (40°C) -25°C ... 70°C (> 60°C derating: 2.5%/K)
<b>Standards/regulations</b>	3 kV AC (routine test) / 4 kV AC (type test)
<b>Insulation voltage input/output</b>	3 kV AC (routine test) / 4 kV AC (type test)
<b>Electromagnetic compatibility</b> <b>Electrical safety</b> Electronic equipm. for electrical power installations Safe isolation UL approvals	Conformance with EMC Directive 2004/108/EC IEC 60950-1/VDE 0805 (SELV) EN 50178/VDE 0160 (PELV) DIN VDE 0100-410 UL Listed UL 508, UL/C-UL Recognized UL 60950-1
<b>Limitation of harmonic line currents</b>	EN 61000-3-2

#### Ordering data

Description	Type	Order No.	Pcs. / Pkt.
Power supply, primary-switched	TRIO-PS-2G/1AC/24DC/3/C2LPS	2903147	1





new

Power supply,  
1 AC, 24 V DC, 5 A



new

Power supply,  
1 AC, 24 V DC, 10 A



new

Power supply,  
1 AC, 24 V DC, 20 A

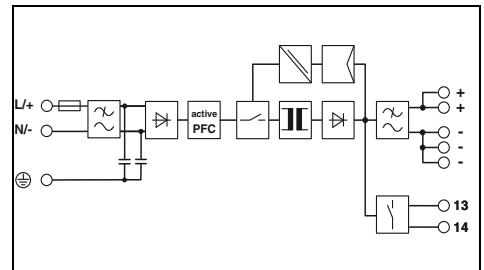
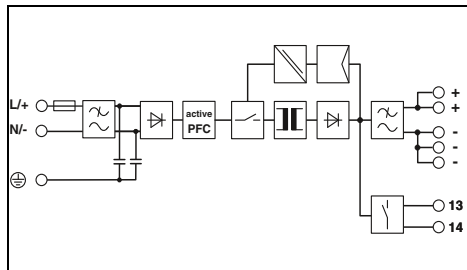
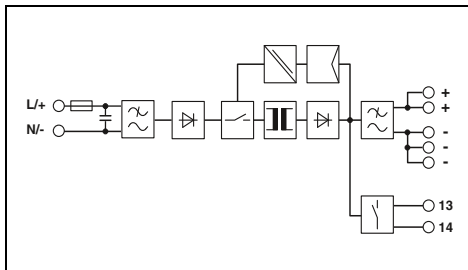

Technical data

100 V AC ... 240 V AC  
85 V AC ... 264 V AC / 99 V DC ... 275 V DC  
50 Hz ... 60 Hz  
2.2 A (100 V AC) / 1.1 A (240 V AC)  
≤ 16 A / < 0.6 A<sup>2</sup>s  
> 20 ms (120 V AC) / > 100 ms (230 V AC)

24 V DC ±1 %  
24 V DC ... 28 V DC (> 24 V constant capacity)

5 A / 7.5 A  
Yes, with redundancy module / Yes  
< 1 W / < 16 W  
> 90% (for 230 V AC and nominal values)  
≤ 50 mV<sub>pp</sub>

LED, floating signal contact

0.45 kg / 35 x 130 x 115 mm  
Alignable: horizontally 0 mm (≤ 40°C) 10 mm (≤ 70°C), vertically 50 mm  
Push-in connection  
0.2 - 4 mm<sup>2</sup> / 0.2 - 2.5 mm<sup>2</sup> / 24 - 12  
0.2 - 4 mm<sup>2</sup> / 0.2 - 2.5 mm<sup>2</sup> / 24 - 12  
IP20 / II  
> 2000000 h (40°C)  
-25°C ... 70°C (> 60°C derating: 2.5%/K)

3 kV AC (routine test) / 4 kV AC (type test)

Conformance with EMC Directive 2004/108/EC  
IEC 60950-1/VDE 0805 (SELV)  
EN 50178/VDE 0160 (PELV)  
DIN VDE 0100-410  
UL Listed UL 508, UL/C-UL Recognized UL 60950-1

EN 61000-3-2

Technical data

100 V AC ... 240 V AC  
85 V AC ... 264 V AC / 99 V DC ... 275 V DC  
50 Hz ... 60 Hz  
3.1 A (100 V AC) / 1.4 A (240 V AC)  
≤ 25 A / < 0.5 A<sup>2</sup>s  
> 15 ms (120 V AC) / > 15 ms (230 V AC)

24 V DC ±1 %  
24 V DC ... 28 V DC (> 24 V constant capacity)

10 A / 15 A  
Yes, with redundancy module / Yes  
< 5.1 W / < 25 W  
> 91% (for 230 V AC and nominal values)  
≤ 10 mV<sub>pp</sub>

LED, floating signal contact

1 kg / 42 x 130 x 160 mm  
Alignable: horizontally 0 mm (≤ 40°C) 10 mm (≤ 70°C), vertically 50 mm  
Push-in connection  
0.2 - 4 mm<sup>2</sup> / 0.2 - 2.5 mm<sup>2</sup> / 24 - 12  
0.2 - 4 mm<sup>2</sup> / 0.2 - 2.5 mm<sup>2</sup> / 24 - 12  
IP20 / I  
> 1000000 h (40°C)  
-25°C ... 70°C (> 60°C derating: 2.5%/K, startup at -40°C type-tested)

1.5 kV AC (routine test) / 4 kV AC (type test)

Conformance with EMC Directive 2004/108/EC  
IEC 60950-1/VDE 0805 (SELV)  
EN 50178/VDE 0160 (PELV)  
DIN VDE 0100-410  
UL Listed UL 508, UL/C-UL Recognized UL 60950-1

EN 61000-3-2

Technical data

100 V AC ... 240 V AC  
85 V AC ... 264 V AC / 99 V DC ... 275 V DC  
50 Hz ... 60 Hz  
5.6 A (100 V AC) / 2.4 A (240 V AC)  
≤ 20 A / < 0.9 A<sup>2</sup>s  
> 10 ms (120 V AC) / > 15 ms (230 V AC)

24 V DC ±1 %  
24 V DC ... 28 V DC (> 24 V constant capacity)

20 A / 30 A  
Yes, with redundancy module / Yes  
< 5.7 W / < 44 W  
> 93% (for 230 V AC and nominal values)  
≤ 30 mV<sub>pp</sub>

LED, floating signal contact

1.5 kg / 68 x 130 x 160 mm  
Alignable: horizontally 0 mm (≤ 40°C) 10 mm (≤ 70°C), vertically 50 mm  
Push-in connection  
0.2 - 4 mm<sup>2</sup> / 0.2 - 2.5 mm<sup>2</sup> / 24 - 12  
0.2 - 10 mm<sup>2</sup> / 0.2 - 6 mm<sup>2</sup> / 24 - 8  
IP20 / I  
> 1000000 h (40°C)  
-25°C ... 70°C (> 60°C derating: 2.5%/K, startup at -40°C type-tested)

1.5 kV AC (routine test) / 4 kV AC (type test)

Conformance with EMC Directive 2004/108/EC  
IEC 60950-1/VDE 0805 (SELV)  
EN 50178/VDE 0160 (PELV)  
DIN VDE 0100-410  
UL Listed UL 508, UL/C-UL Recognized UL 60950-1

EN 61000-3-2

Ordering data

Type	Order No.	Pcs. / Pkt.
TRIO-PS-2G/1AC/24DC/5	2903148	1

Ordering data

Type	Order No.	Pcs. / Pkt.
TRIO-PS-2G/1AC/24DC/10	2903149	1

Ordering data

Type	Order No.	Pcs. / Pkt.
TRIO-PS-2G/1AC/24DC/20	2903151	1

# Power supplies and UPS

## Power supply units

### TRIO POWER power supplies – robust standard functionality

#### TRIO POWER 3 AC, 24 V DC, 40 A

- Error-free function, even if one phase fails permanently
- High operational reliability thanks to the robust design
- Wide temperature range from -25°C to +70°C
- Third negative terminal block for grounding on the secondary side
- Maximum availability thanks to high MTBF (mean time between failure)
- Compensation of voltage drops by means of output voltage that can be set on the front

#### TRIO POWER 3 AC, 24 V DC, with push-in connection technology

The TRIO POWER power supply range with push-in connection technology offers further additional functions:

- Wide temperature range from -25°C to +70°C as well as device startup at -40°C (type-tested)
- Reliable starting of difficult loads with the dynamic BOOST, which supplies up to 1.5 times the nominal current for 5 seconds
- Time savings during installation thanks to the use of tool-free push-in connection technology
- Space savings in the control cabinet thanks to the narrow design
- Active function monitoring with DC OK LED and relay contact
- Input voltage range for DC voltage of 600 V DC



new

Power supply,  
3 AC, 24 V DC, 5 A

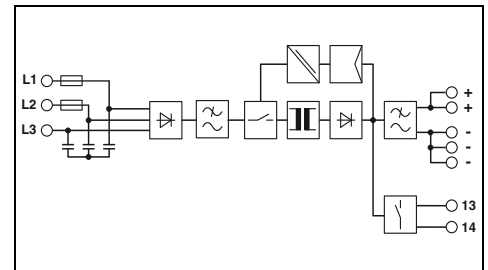

#### Technical data

##### Input data

Nominal input voltage range  
Input voltage range

Frequency range  
Current consumption (nominal load)  
Inrush current limitation at 25°C (typ.) / I<sup>2</sup>t  
Mains buffering (I<sub>h</sub>, typ.)

##### Output data

Nominal output voltage  
Setting range of the output voltage

Output current / Dynamic BOOST (5 s)  
Can be connected in parallel / series  
Max. power dissipation (no load / nominal load)  
Efficiency (typ.)  
Residual ripple

##### Signaling

Signaling DC OK

##### General data

Weight / Dimensions W x H x D  
Spacing when mounting

##### Connection method

Input connection data (solid / stranded / AWG)  
Output connection data (solid / stranded / AWG)  
Degree of protection / Protection class  
MTBF (IEC 61709, SN 29500)  
Ambient temperature (operation)

##### Standards/regulations

Insulation voltage input/output

Electromagnetic compatibility  
Electrical safety  
Electronic equipm. for electrical power installations  
Safe isolation  
UL approvals

Limitation of harmonic line currents

2/3x 400 V AC ... 500 V AC  
3x 320 V AC ... 575 V AC / 2x 360 V AC ... 575 V AC /  
450 V DC ... 780 V DC  
50 Hz ... 60 Hz  
3x 0.4 A (400 V AC) / 3x 0.3 A (500 V AC)  
≤ 22 A / ≤ 0.25 A<sup>2</sup>s  
> 20 ms (400 V AC) / > 20 ms (500 V AC)

24 V DC ± 1 %  
24 V DC ... 28 V DC (> 24 V constant capacity)

5 A / 7.5 A  
Yes, with redundancy module / Yes  
< 1 W / < 12 W  
> 91% (at 400 V AC and nominal values)  
≤ 20 mV<sub>pp</sub>

LED, floating signal contact

0.4 kg / 35 x 130 x 115 mm  
Alignable: horizontally 0 mm (≤ 40°C) 10 mm (≤ 70°C),  
vertically 50 mm  
Push-in connection  
0.2 - 4 mm<sup>2</sup> / 0.2 - 2.5 mm<sup>2</sup> / 24 - 12  
0.2 - 4 mm<sup>2</sup> / 0.2 - 2.5 mm<sup>2</sup> / 24 - 12  
IP20 / II  
> 1300000 h (40°C)  
-25°C ... 70°C (> 60°C derating: 2.5%/K)

3 kV AC (routine test) / 4 kV AC (type test)

Conformance with EMC Directive 2004/108/EC  
IEC 60950-1/VDE 0805 (SELV)  
EN 50178/VDE 0160 (PELV)  
DIN VDE 0100-410  
UL Listed UL 508, UL/C-UL Recognized UL 60950-1

EN 61000-3-2

#### Ordering data

Description

Power supply, primary-switched

Type	Order No.	Pcs. / Pkt.
TRIO-PS-2G/3AC/24DC/5	2903153	1



new

Power supply,  
3 AC, 24 V DC, 10 A



new

Power supply,  
3 AC, 24 V DC, 20 A



Power supply,  
3 AC, 24 V DC, 40 A

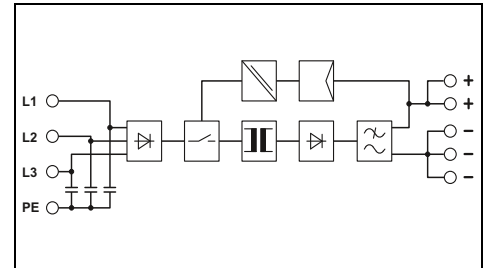
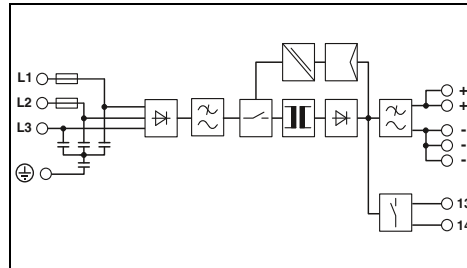
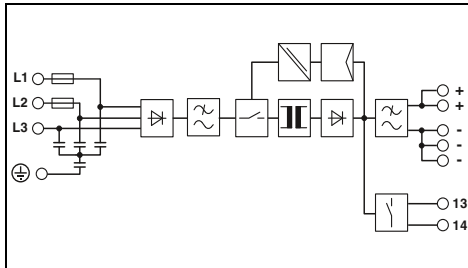

Technical data

2/3x 400 V AC ... 500 V AC  
3x 320 V AC ... 575 V AC / 2x 360 V AC ... 575 V AC /  
450 V DC ... 780 V DC  
50 Hz ... 60 Hz  
3x 0.6 A (400 V AC) / 3x 0.6 A (500 V AC)  
≤ 26 A / 0.3 A<sup>2</sup>s  
> 10 ms (400 V AC) / > 20 ms (500 V AC)

24 V DC ±1 %  
24 V DC ... 28 V DC (> 24 V constant capacity)

10 A / 15 A  
Yes, with redundancy module / Yes  
< 1.1 W / < 22 W  
> 92% (at 400 V AC and nominal values)  
≤ 20 mV<sub>pp</sub>

LED, floating signal contact

0.9 kg / 42 x 130 x 160 mm  
Alignable: horizontally 0 mm (≤ 40°C) 10 mm (≤ 70°C),  
vertically 50 mm  
Push-in connection  
0.2 - 4 mm<sup>2</sup> / 0.2 - 2.5 mm<sup>2</sup> / 24 - 12  
0.2 - 4 mm<sup>2</sup> / 0.2 - 2.5 mm<sup>2</sup> / 24 - 12  
IP20 / I  
> 1200000 h (40°C)  
-25°C ... 70°C (> 60°C derating: 2.5%/K,  
startup at -40°C type-tested)

1.5 kV AC (routine test) / 4 kV AC (type test)

Conformance with EMC Directive 2004/108/EC  
IEC 60950-1/VDE 0805 (SELV)  
EN 50178/VDE 0160 (PELV)  
DIN VDE 0100-410  
UL Listed UL 508, UL/C-UL Recognized UL 60950-1

EN 61000-3-2

Technical data

2/3x 400 V AC ... 500 V AC  
3x 320 V AC ... 575 V AC / 2x 360 V AC ... 575 V AC /  
450 V DC ... 780 V DC  
50 Hz ... 60 Hz  
3x 1.2 A (400 V AC) / 3x 1 A (500 V AC)  
≤ 22 A / 0.5 A<sup>2</sup>s  
> 10 ms (400 V AC) / > 20 ms (500 V AC)

24 V DC ±1 %  
24 V DC ... 28 V DC (> 24 V constant capacity)

20 A / 30 A  
Yes, with redundancy module / Yes  
< 1.2 W / < 38 W  
> 93% (at 400 V AC and nominal values)  
≤ 20 mV<sub>pp</sub>

LED, floating signal contact

1.5 kg / 65 x 130 x 160 mm  
Alignable: horizontally 0 mm (≤ 40°C) 10 mm (≤ 70°C),  
vertically 50 mm  
Push-in connection  
0.2 - 4 mm<sup>2</sup> / 0.2 - 2.5 mm<sup>2</sup> / 24 - 12  
0.2 - 10 mm<sup>2</sup> / 0.2 - 6 mm<sup>2</sup> / 24 - 8  
IP20 / I  
> 1100000 h (40°C)  
-25°C ... 70°C (> 60°C derating: 2.5%/K,  
startup at -40°C type-tested)

1.5 kV AC (routine test) / 4 kV AC (type test)

Conformance with EMC Directive 2004/108/EC  
IEC 60950-1/VDE 0805 (SELV)  
EN 50178/VDE 0160 (PELV)  
DIN VDE 0100-410  
UL Listed UL 508, UL/C-UL Recognized UL 60950-1

EN 61000-3-2

Technical data

3x 400 V AC ... 500 V AC  
3x 320 V AC ... 575 V AC / 2x 360 V AC ... 575 V AC  
45 Hz ... 65 Hz  
3x 2 A (400 V AC) / 3x 1.6 A (480 V AC)  
< 20 A / 1.3 A<sup>2</sup>s  
> 16 ms (400 V AC) / > 20 ms (480 V AC)

24 V DC ±1 %  
22.5 V DC ... 29.5 V DC (> 24 V constant capacity)

40 A / -  
Yes / Yes  
16 W / 91 W  
> 91.5% (at 400 V AC and nominal values)  
≤ 20 mV<sub>pp</sub>

LED

2.9 kg / 139 x 130 x 190 mm  
Alignable: horizontally 0 mm,  
vertically 50 mm  
Screw connection  
0.2 - 6 mm<sup>2</sup> / 0.2 - 4 mm<sup>2</sup> / 22 - 10  
0.5 - 16 mm<sup>2</sup> / 0.5 - 10 mm<sup>2</sup> / 8 - 6  
IP20 / I  
> 930000 h (40°C)  
-25°C ... 70°C (> 55°C derating: 2.5%/K)

2 kV AC (routine test) / 4 kV AC (type test)

Conformance with EMC Directive 2004/108/EC  
EN 60950-1/VDE 0805 (SELV)  
EN 50178/VDE 0160 (PELV)  
DIN VDE 0100-410, DIN VDE 0106-1010  
UL/C-UL listed UL 508, UL/C-UL Recognized UL 60950

EN 61000-3-2

Ordering data

Type	Order No.	Pcs. / Pkt.
TRIO-PS-2G/3AC/24DC/10	2903154	1

Ordering data

Type	Order No.	Pcs. / Pkt.
TRIO-PS-2G/3AC/24DC/20	2903155	1

Ordering data

Type	Order No.	Pcs. / Pkt.
TRIO-PS/3AC/24DC/40	2866404	1

# Power supplies and UPS

## Power supply units

### TRIO POWER power supplies – robust standard functionality

#### TRIO POWER, 1 AC

- Robust design and wide temperature range from -25°C to +70°C
- Third negative terminal block for grounding on the secondary side
- Maximum availability thanks to high MTBF (mean time between failure)

#### TRIO POWER, 600 V DC, 24 V DC

- Connection to 600 V DC intermediate circuits of frequency inverters



Power supply,  
600 V DC, 24 V DC, 20 A



Power supply,  
1 AC, 12 V DC, 5 A

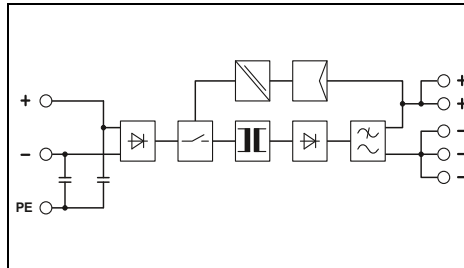

#### Technical data

Input data	
Nominal input voltage range	600 V DC
Input voltage range	450 V DC ... 840 V DC
Frequency range	- / 0 Hz
Current consumption (nominal load)	0.9 A (600 V DC)
Inrush current limitation at 25°C (typ.) / I <sup>2</sup> t	< 26 A / 0.8 A <sup>2</sup> s
Mains buffering (I <sub>N</sub> , typ.)	> 15 ms (600 V DC)
Output data	
Nominal output voltage	24 V DC ± 1 %
Setting range of the output voltage	22.5 V DC ... 29.5 V DC (U <sub>IN</sub> > 475 V DC) 22.5 V DC ... 28 V DC (U <sub>IN</sub> ≤ 475 V DC)
Output current	
Can be connected in parallel / series	20 A Yes / Yes
Max. power dissipation (no load / nominal load)	3.8 W / 45 W
Efficiency (typ.)	> 91% (for 600 V DC and nominal values)
Residual ripple	< 40 mV <sub>pp</sub>
Signaling	
Signaling DC OK	LED
General data	
Weight / Dimensions W x H x D	2 kg / 115 x 130 x 152.5 mm
Spacing when mounting	Alignable: horizontally 0 mm, vertically 50 mm
Connection method	Screw connection
Input connection data (solid / stranded / AWG)	0.2 - 2.5 mm <sup>2</sup> / 0.2 - 2.5 mm <sup>2</sup> / 24 - 14
Output connection data (solid / stranded / AWG)	0.5 - 6 mm <sup>2</sup> / 0.5 - 4 mm <sup>2</sup> / 12 - 10
Degree of protection / Protection class	IP20 / I
MTBF (IEC 61709, SN 29500)	> 701000 h (40°C)
Ambient temperature (operation)	-25°C ... 70°C (> 55° C derating: 2.5%/K)
Standards/regulations	
Insulation voltage input/output	2 kV AC (routine test) / 4 kV AC (type test)
Electromagnetic compatibility	Conformance with EMC Directive 2004/108/EC
Electrical safety	EN 60950-1/VDE 0805 (SELV)
Electronic equipm. for electrical power installations	EN 50178/VDE 0160 (PELV)
Safe isolation	DIN VDE 0100-410, DIN VDE 0106-1010
UL approvals	UL/C-UL listed UL 508, UL/C-UL Recognized UL 60950
Limitation of harmonic line currents	
	EN 61000-3-2

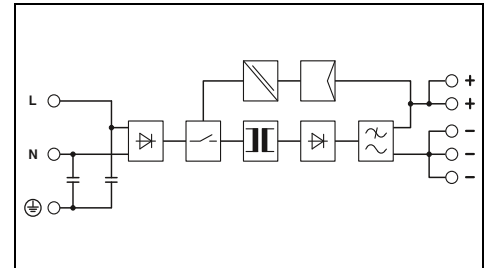

#### Technical data

Input data	
Nominal input voltage range	100 V AC ... 240 V AC
Input voltage range	85 V AC ... 264 V AC
Frequency range	45 Hz ... 65 Hz
Current consumption (nominal load)	1.1 A (100 V AC) / 0.5 A (240 V AC)
Inrush current limitation at 25°C (typ.) / I <sup>2</sup> t	< 15 A / < 0.5 A <sup>2</sup> s
Mains buffering (I <sub>N</sub> , typ.)	> 26 ms (120 V AC) / > 100 ms (230 V AC)
Output data	
Nominal output voltage	12 V DC ± 1 %
Setting range of the output voltage	10 V DC ... 18 V DC (> 12 V constant capacity)
Output current	
Can be connected in parallel / series	5 A Yes / Yes
Max. power dissipation (no load / nominal load)	0.9 W / 11 W
Efficiency (typ.)	> 83% (for 230 V AC and nominal values)
Residual ripple	< 20 mV <sub>pp</sub>
Signaling	
Signaling DC OK	LED
General data	
Weight / Dimensions W x H x D	0.5 kg / 32 x 130 x 115 mm
Spacing when mounting	Alignable: horizontally 0 mm, vertically 50 mm
Connection method	Screw connection
Input connection data (solid / stranded / AWG)	0.2 - 2.5 mm <sup>2</sup> / 0.2 - 2.5 mm <sup>2</sup> / 24 - 14
Output connection data (solid / stranded / AWG)	0.2 - 2.5 mm <sup>2</sup> / 0.2 - 2.5 mm <sup>2</sup> / 24 - 14
Degree of protection / Protection class	IP20 / I
MTBF (IEC 61709, SN 29500)	> 1853000 h (40°C)
Ambient temperature (operation)	-25°C ... 70°C (> 55° C derating: 2.5%/K)
Standards/regulations	
Insulation voltage input/output	2 kV AC (routine test) / 4 kV AC (type test)
Electromagnetic compatibility	Conformance with EMC Directive 2004/108/EC
Electrical safety	EN 60950-1/VDE 0805 (SELV)
Electronic equipm. for electrical power installations	EN 50178/VDE 0160 (PELV)
Safe isolation	DIN VDE 0100-410, DIN VDE 0106-1010
UL approvals	UL/C-UL listed UL 508, UL/C-UL Recognized UL 60950
Limitation of harmonic line currents	
	EN 61000-3-2

#### Ordering data

Description	Type	Order No.	Pcs. / Pkt.
Power supply, primary-switched	TRIO-PS/600DC/24DC/20	2866530	1

#### Ordering data

Description	Type	Order No.	Pcs. / Pkt.
Power supply, primary-switched	TRIO-PS/1AC/12DC/5	2866475	1



Power supply,  
1 AC, 12 V DC, 10 A



Power supply,  
1 AC, 48 V DC, 5 A



Power supply,  
1 AC, 48 V DC, 10 A

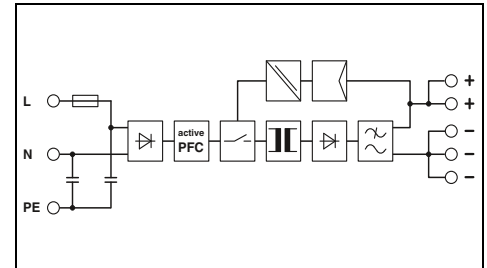
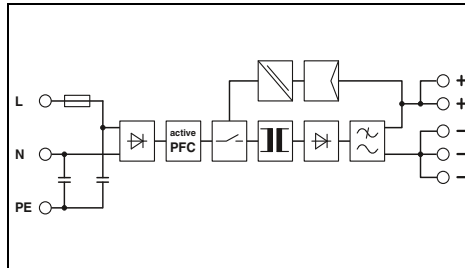
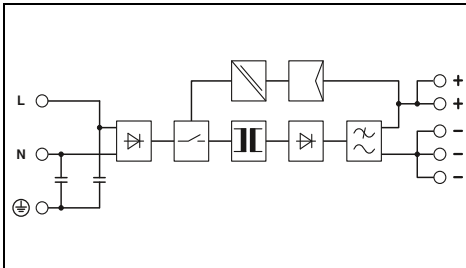

Technical data

100 V AC ... 240 V AC  
85 V AC ... 264 V AC  
45 Hz ... 65 Hz  
1.7 A (120 V AC) / 0.9 A (230 V AC)  
< 15 A / < 1.1 A<sup>2</sup>s  
> 20 ms (120 V AC) / > 86 ms (230 V AC)

12 V DC ±1 %  
10 V DC ... 18 V DC (> 12 V constant capacity)

10 A  
Yes / Yes  
1.1 W / 18 W  
> 86% (for 230 V AC and nominal values)  
< 20 mV<sub>PP</sub>

LED

0.6 kg / 40 x 130 x 115 mm  
Alignable: horizontally 0 mm, vertically 50 mm  
Screw connection  
0.2 - 2.5 mm<sup>2</sup> / 0.2 - 2.5 mm<sup>2</sup> / 24 - 14  
0.2 - 2.5 mm<sup>2</sup> / 0.2 - 2.5 mm<sup>2</sup> / 24 - 14  
IP20 / I  
> 1871000 h (40°C)  
-25°C ... 70°C (> 55° C derating: 2.5%/K)

2 kV AC (routine test) / 4 kV AC (type test)  
Conformance with EMC Directive 2004/108/EC  
EN 60950-1/VDE 0805 (SELV)  
EN 50178/VDE 0160 (PELV)  
DIN VDE 0100-410, DIN VDE 0106-1010  
UL/C-UL listed UL 508, UL/C-UL Recognized UL 60950

EN 61000-3-2

Ordering data

Type	Order No.	Pcs. / Pkt.
TRIO-PS/1AC/12DC/10	2866488	1

Technical data

100 V AC ... 240 V AC  
85 V AC ... 264 V AC  
45 Hz ... 65 Hz  
2.5 A (120 V AC) / 1.3 A (230 V AC)  
< 15 A / < 0.7 A<sup>2</sup>s  
> 15 ms (120 V AC) / > 16 ms (230 V AC)

48 V DC ±1 %  
30 V DC ... 56 V DC (> 48 V constant capacity)

5 A  
Yes / Yes  
7 W / 28 W  
> 89% (for 230 V AC and nominal values)  
< 50 mV<sub>PP</sub>

LED

1.4 kg / 60 x 130 x 152.5 mm  
Alignable: horizontally 0 mm, vertically 50 mm  
Screw connection  
0.2 - 2.5 mm<sup>2</sup> / 0.2 - 2.5 mm<sup>2</sup> / 24 - 14  
0.2 - 2.5 mm<sup>2</sup> / 0.2 - 2.5 mm<sup>2</sup> / 24 - 14  
IP20 / I  
> 1337000 h (40°C)  
-25°C ... 70°C (> 55° C derating: 2.5%/K)

2 kV AC (routine test) / 4 kV AC (type test)  
Conformance with EMC Directive 2004/108/EC  
EN 60950-1/VDE 0805 (SELV)  
EN 50178/VDE 0160 (PELV)  
DIN VDE 0100-410, DIN VDE 0106-1010  
UL/C-UL listed UL 508, UL/C-UL Recognized UL 60950

EN 61000-3-2

Ordering data

Type	Order No.	Pcs. / Pkt.
TRIO-PS/1AC/48DC/5	2866491	1

Technical data

100 V AC ... 240 V AC  
85 V AC ... 264 V AC  
45 Hz ... 65 Hz  
4.6 A (120 V AC) / 2.4 A (230 V AC)  
< 15 A / < 1.4 A<sup>2</sup>s  
> 13 ms (120 V AC) / > 18 ms (230 V AC)

48 V DC ±1 %  
30 V DC ... 56 V DC (> 48 V constant capacity)

10 A  
Yes / Yes  
8 W / 49 W  
> 91% (for 230 V AC and nominal values)  
< 50 mV<sub>PP</sub>

LED

1.9 kg / 115 x 130 x 152.5 mm  
Alignable: horizontally 0 mm, vertically 50 mm  
Screw connection  
0.2 - 2.5 mm<sup>2</sup> / 0.2 - 2.5 mm<sup>2</sup> / 24 - 14  
0.5 - 6 mm<sup>2</sup> / 0.5 - 4 mm<sup>2</sup> / 20 - 10  
IP20 / I  
> 1168000 h (40°C)  
-25°C ... 70°C (> 55° C derating: 2.5%/K)

2 kV AC (routine test) / 4 kV AC (type test)  
Conformance with EMC Directive 2004/108/EC  
EN 60950-1/VDE 0805 (SELV)  
EN 50178/VDE 0160 (PELV)  
DIN VDE 0100-410, DIN VDE 0106-1010  
UL Listed UL 508, UL/C-UL Recognized UL 60950

EN 61000-3-2

Ordering data

Type	Order No.	Pcs. / Pkt.
TRIO-PS/1AC/48DC/10	2866501	1

## Power supply units

### UNO POWER power supplies – compact with basic functionality

#### UNO POWER, 1 AC, 12 V DC and 24 V DC

- The wide range of products covers all common voltage levels
- Maximum energy efficiency: save energy thanks to high efficiency and extremely low idling losses
- Save space in the control cabinet thanks to extremely high power density
- Housing height of 84 mm, tailored to all popular 120 mm control boxes
- Wide temperature range from -25°C to +70°C



**Power supply,  
1 AC, 24 DC, 30 W  
NEC Class 2**

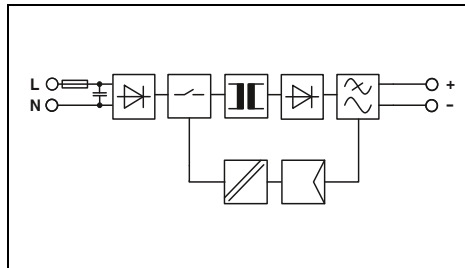

#### Technical data

<b>Input data</b>	
Nominal input voltage range	100 V AC ... 240 V AC
Input voltage range	85 V AC ... 264 V AC
Frequency range	45 Hz ... 65 Hz
Current consumption (nominal load)	0.5 A (120 V AC) / 0.3 A (230 V AC)
Inrush current limitation at 25°C (typ.) / I <sup>2</sup> t	< 20 A / < 0.4 A <sup>2</sup> s
Mains buffering (I <sub>N</sub> , typ.)	> 25 ms (120 V AC) / > 115 ms (230 V AC)
<b>Output data</b>	
Nominal output voltage	24 V DC ±1 %
Output current	1.25 A
Can be connected in parallel / series	Yes, with redundancy module / Yes
Max. power dissipation (no load / nominal load)	< 0.3 W / < 5 W
Efficiency (typ.)	> 88% (for 230 V AC and nominal values)
Residual ripple	< 60 mV <sub>pp</sub>
<b>Signaling</b>	
Signaling DC OK	LED
<b>General data</b>	
Weight / Dimensions W x H x D	0.15 kg / 22.5 x 90 x 84 mm
Spacing when mounting	Alignable: 0 mm horizontally, 30 mm vertically
Connection method	Screw connection
Connection data solid / stranded / AWG	0.2 - 2.5 mm <sup>2</sup> / 0.2 - 2.5 mm <sup>2</sup> / 24 - 14
Degree of protection / Protection class	IP20 / II
MTBF (IEC 61709, SN 29500)	> 1158000 h (40°C)
Ambient temperature (operation)	-25°C ... 70°C (> 55° C derating: 2.5%/K)
<b>Standards/regulations</b>	
Insulation voltage input/output	3 kV AC (routine test) / 4 kV AC (type test)
Electromagnetic compatibility	Conformance with EMC Directive 2004/108/EC
Electrical safety	IEC 60950-1/VDE 0805 (SELV)
Electronic equipm. for electrical power installations	EN 50178/VDE 0160 (PELV)
Safe isolation	DIN VDE 0100-410
UL approvals	UL/C-UL listed UL 508, UL/C-UL Recognized UL 60950, NEC Class 2 as per UL 1310, EN 61000-3-2
<b>Limitation of harmonic line currents</b>	

#### Ordering data

Description	Type	Order No.	Pcs. / Pkt.
Power supply, primary-switched	UNO-PS/1AC/24DC/ 30W	2902991	1



**Power supply,  
1 AC, 24 DC, 60 W  
NEC Class 2**

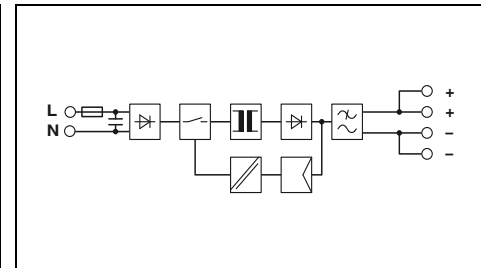

#### Technical data

<b>Input data</b>	
Nominal input voltage range	100 V AC ... 240 V AC
Input voltage range	85 V AC ... 264 V AC
Frequency range	45 Hz ... 65 Hz
Current consumption (nominal load)	1 A (120 V AC) / 0.6 A (230 V AC)
Inrush current limitation at 25°C (typ.) / I <sup>2</sup> t	< 30 A / < 0.5 A <sup>2</sup> s
Mains buffering (I <sub>N</sub> , typ.)	> 20 ms (120 V AC) / > 85 ms (230 V AC)
<b>Output data</b>	
Nominal output voltage	24 V DC ±1 %
Output current	2.5 A
Can be connected in parallel / series	Yes, with redundancy module / Yes
Max. power dissipation (no load / nominal load)	< 0.3 W / < 7 W
Efficiency (typ.)	> 90% (for 230 V AC and nominal values)
Residual ripple	< 30 mV <sub>pp</sub>
<b>Signaling</b>	
Signaling DC OK	LED
<b>General data</b>	
Weight / Dimensions W x H x D	0.2 kg / 35 x 90 x 84 mm
Spacing when mounting	Alignable: 0 mm horizontally, 30 mm vertically
Connection method	Screw connection
Connection data solid / stranded / AWG	0.2 - 2.5 mm <sup>2</sup> / 0.2 - 2.5 mm <sup>2</sup> / 24 - 14
Degree of protection / Protection class	IP20 / II
MTBF (IEC 61709, SN 29500)	> 785000 h (40°C)
Ambient temperature (operation)	-25°C ... 70°C (> 55° C derating: 2.5%/K)
<b>Standards/regulations</b>	
Insulation voltage input/output	3 kV AC (routine test) / 4 kV AC (type test)
Electromagnetic compatibility	Conformance with EMC Directive 2004/108/EC
Electrical safety	IEC 60950-1/VDE 0805 (SELV)
Electronic equipm. for electrical power installations	EN 50178/VDE 0160 (PELV)
Safe isolation	DIN VDE 0100-410
UL approvals	UL Listed UL 508, UL/C-UL Recognized UL 60950, NEC Class 2 as per UL 1310, EN 61000-3-2
<b>Limitation of harmonic line currents</b>	

#### Ordering data

Description	Type	Order No.	Pcs. / Pkt.
Power supply, primary-switched	UNO-PS/1AC/24DC/ 60W	2902992	1



Power supply,  
1 AC, 24 DC, 100 W



Power supply,  
1 AC, 24 DC, 150 W

new



Power supply,  
1 AC, 24 DC, 240 W

new

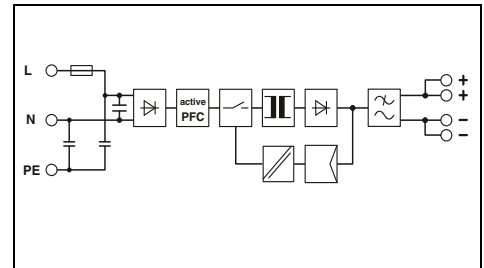
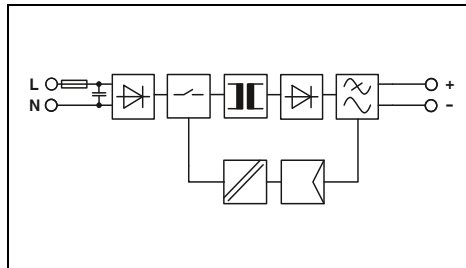
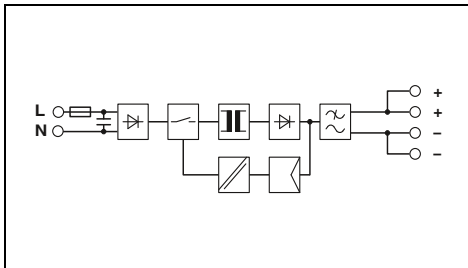

Technical data

100 V AC ... 240 V AC  
85 V AC ... 264 V AC  
45 Hz ... 65 Hz  
1.7 A (120 V AC) / 1 A (230 V AC)  
< 40 A / < 1.5 A<sup>2</sup>s  
> 20 ms (120 V AC) / > 100 ms (230 V AC)

24 V DC ±1 %  
4.2 A  
Yes, with redundancy module / Yes  
< 0.5 W / < 11 W  
> 90% (for 230 V AC and nominal values)  
< 30 mV<sub>pp</sub>

LED

0.34 kg / 55 x 90 x 84 mm  
Alignable: 0 mm horizontally, 30 mm vertically  
Screw connection  
0.2 - 2.5 mm<sup>2</sup> / 0.2 - 2.5 mm<sup>2</sup> / 24 - 14  
IP20 / II  
> 738000 h (40°C)  
-25°C ... 70°C (> 55°C derating: 2.5%/K)

3 kV AC (routine test) / 4 kV AC (type test)  
Conformance with EMC Directive 2004/108/EC  
IEC 60950-1/VDE 0805 (SELV)  
EN 50178/VDE 0160 (PELV)  
DIN VDE 0100-410  
UL Listed UL 508, UL/C-UL Recognized UL 60950

EN 61000-3-2

Technical data

100 V AC ... 240 V AC  
85 V AC ... 264 V AC  
45 Hz ... 65 Hz  
1.4 A (120 V AC) / 0.8 A (230 V AC)  
< 50 A / < 0.8 A<sup>2</sup>s  
> 20 ms (120 V AC) / > 20 ms (230 V AC)

24 V DC ±1 %  
6.25 A  
Yes, with redundancy module / No  
< 1.2 W / < 9.7 W  
> 94% (for 230 V AC and nominal values)  
< 40 mV<sub>pp</sub>

LED

0.5 kg / 37 x 130 x 125 mm  
Alignable: 0 mm horizontally, 30 mm vertically  
Screw connection  
0.2 - 2.5 mm<sup>2</sup> / 0.2 - 2.5 mm<sup>2</sup> / 24 - 14  
IP20 / II  
> 868000 h (40°C)  
-25°C ... 70°C (> 55°C derating: 2.5%/K)

3 kV AC (routine test) / 4 kV AC (type test)  
Conformance with EMC Directive 2004/108/EC  
EN 60950-1/VDE 0805 (SELV)  
EN 50178/VDE 0160 (PELV)  
DIN VDE 0100-410  
UL Listed UL 508, UL/C-UL Recognized UL 60950

EN 61000-3-2

Technical data

100 V AC ... 240 V AC  
85 V AC ... 264 V AC  
45 Hz ... 65 Hz  
2.3 A (120 V AC) / 1.2 A (230 V AC)  
< 80 A / < 2 A<sup>2</sup>s  
> 10 ms (120 V AC) / > 10 ms (230 V AC)

24 V DC ±1 %  
10 A  
Yes, with redundancy module / No  
< 1.1 W / < 18.8 W  
> 93% (for 230 V AC and nominal values)  
< 50 mV<sub>pp</sub>

LED

0.66 kg / 45 x 130 x 125 mm  
Alignable: 0 mm horizontally, 30 mm vertically  
Screw connection  
0.2 - 2.5 mm<sup>2</sup> / 0.2 - 2.5 mm<sup>2</sup> / 24 - 14  
IP20 / I  
> 562000 h (40°C)  
-25°C ... 70°C (> 55°C derating: 2.5%/K)

3 kV AC (routine test) / 4 kV AC (type test)  
Conformance with EMC Directive 2004/108/EC  
EN 60950-1/VDE 0805 (SELV)  
EN 50178/VDE 0160 (PELV)  
DIN VDE 0100-410  
UL Listed UL 508, UL/C-UL Recognized UL 60950

EN 61000-3-2

Ordering data

Type	Order No.	Pcs. / Pkt.
UNO-PS/1AC/24DC/100W	2902993	1

Ordering data

Type	Order No.	Pcs. / Pkt.
UNO-PS/1AC/24DC/150W	2904376	1

Ordering data

Type	Order No.	Pcs. / Pkt.
UNO-PS/1AC/24DC/240W	2904372	1

# Power supplies and UPS

## Power supply units

### UNO POWER power supplies – compact with basic functionality

#### UNO POWER, 1 AC, 5 V DC, 12 V DC, and 24 V DC

- The wide range of products covers all common voltage levels
- Maximum energy efficiency: save energy thanks to high efficiency and extremely low idling losses
- Save space in the control cabinet thanks to extremely high power density
- Housing height of 84 mm, tailored to all popular 120 mm control boxes
- Wide temperature range from -25°C to +70°C

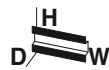

**Power supply,  
1 AC, 24 DC, 90 W  
NEC Class 2**



**Power supply,  
2 AC, 24 DC, 90 W  
NEC Class 2**



#### UNO POWER, NEC Class 2

Output power limited to 100 W

- Specifically for applications that require certification according to UL 1310/508 Listed Class 2

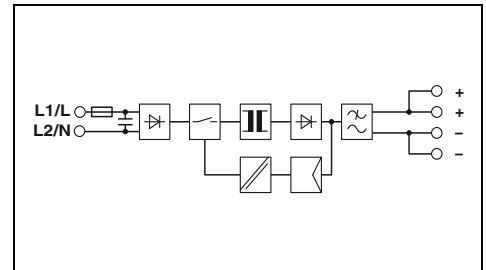
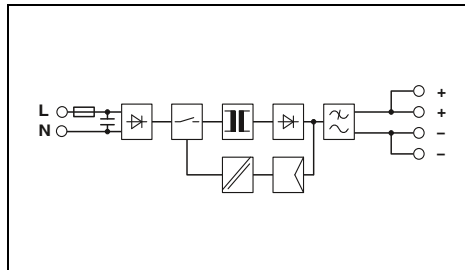

#### Technical data

Input data
Nominal input voltage range
Input voltage range
Frequency range
Current consumption (nominal load)
Inrush current limitation at 25°C (typ.) / I <sup>2</sup> t
Mains buffering (I <sub>N</sub> , typ.)
Output data
Nominal output voltage
Output current
Can be connected in parallel / series
Max. power dissipation (no load / nominal load)
Efficiency (typ.)
Residual ripple
Signaling
Signaling DC OK
General data
Weight / Dimensions W x H x D
Spacing when mounting
Connection method
Connection data solid / stranded / AWG
Degree of protection / Protection class
MTBF (IEC 61709, SN 29500)
Ambient temperature (operation)
Standards/regulations
Insulation voltage input/output
Electromagnetic compatibility
Electrical safety
Electronic equipm. for electrical power installations
Safe isolation
UL approvals
Limitation of harmonic line currents

100 V AC ... 240 V AC
85 V AC ... 264 V AC
45 Hz ... 65 Hz
1.5 A (120 V AC) / 1 A (230 V AC)
< 40 A / < 1.5 A <sup>2</sup> s
> 25 ms (120 V AC) / > 100 ms (230 V AC)
24 V DC ±1 %
3.75 A
No / No
< 0.5 W / < 12 W
> 88.5% (for 230 V AC and nominal values)
< 45 mV <sub>pp</sub>
LED
0.34 kg / 55 x 90 x 84 mm
Alignable: 0 mm horizontally, 30 mm vertically
Screw connection
0.2 - 2.5 mm <sup>2</sup> / 0.2 - 2.5 mm <sup>2</sup> / 24 - 14
IP20 / II
> 1159000 h (40°C)
-25°C ... 70°C (> 55° C derating: 2.5%/K)
3 kV AC (routine test) / 4 kV AC (type test)
Conformance with EMC Directive 2004/108/EC
IEC 60950-1/VDE 0805 (SELV)
EN 50178/VDE 0160 (PELV)
DIN VDE 0100-410
UL/C-UL listed UL 508, UL/C-UL Recognized UL 60950, NEC Class 2 as per UL 1310
EN 61000-3-2

#### Ordering data

Description	Type	Order No.	Pcs. / Pkt.
Power supply, primary-switched	UNO-PS/1AC/24DC/90W/C2LPS	2902994	1

#### Technical data

2x 400 V AC ... 500 V AC
2x 264 V AC ... 575 V AC
45 Hz ... 65 Hz
0.6 A (400 V AC) / 0.5 A (500 V AC)
< 30 A / < 0.5 A <sup>2</sup> s
> 65 ms (400 V AC) / > 100 ms (500 V AC)
24 V DC ±1 %
3.75 A / 3.38 A
No / No
< 0.7 W / < 12 W
> 89.5%
< 50 mV <sub>pp</sub>
LED
0.32 kg / 55 x 90 x 84 mm
Alignable: 0 mm horizontally, 30 mm vertically
Screw connection
0.2 - 2.5 mm <sup>2</sup> / 0.2 - 2.5 mm <sup>2</sup> / 24 - 14
IP20 / II
> 828000 h (40°C)
-25°C ... 70°C (> 55° C derating: 2.5%/K)
3 kV AC (routine test) / 4 kV AC (type test)
Conformance with EMC Directive 2004/108/EC
IEC 60950-1/VDE 0805 (SELV)
EN 50178/VDE 0160 (PELV)
DIN VDE 0100-410
UL/C-UL listed UL 508, UL/C-UL Recognized UL 60950, NEC Class 2 as per UL 1310
EN 61000-3-2

#### Ordering data

Description	Type	Order No.	Pcs. / Pkt.
Power supply, primary-switched	UNO-PS/2AC/24DC/90W/C2LPS	2904371	1





Power supply,  
1 AC, 12 DC, 30 W



Power supply,  
1 AC, 12 DC, 55 W



Power supply,  
1 AC, 12 DC, 100 W

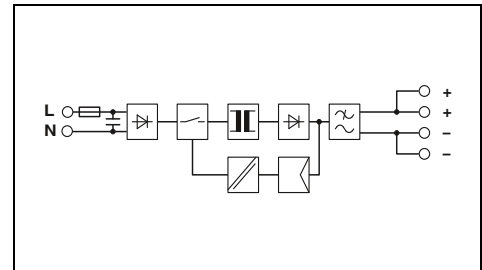
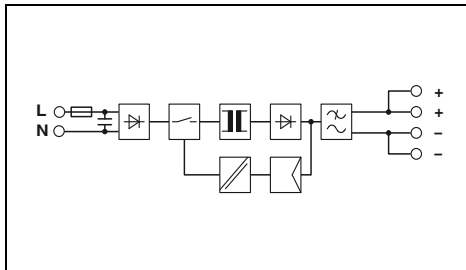
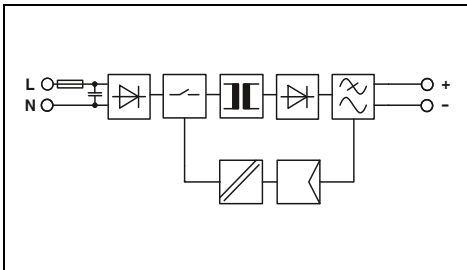

Technical data

100 V AC ... 240 V AC  
85 V AC ... 264 V AC  
45 Hz ... 65 Hz  
0.5 A (120 V AC) / 0.3 A (230 V AC)  
< 25 A / < 0.3 A<sup>2</sup>s  
> 20 ms (120 V AC) / > 120 ms (230 V AC)

12 V DC ±1 %  
2.5 A  
Yes, with redundancy module / Yes  
< 0.3 W / < 4.6 W  
> 87% (for 230 V AC and nominal values)  
< 30 mV<sub>pp</sub>

LED

0.15 kg / 22.5 x 90 x 84 mm  
Alignable: 0 mm horizontally, 30 mm vertically  
Screw connection  
0.2 - 2.5 mm<sup>2</sup> / 0.2 - 2.5 mm<sup>2</sup> / 24 - 14  
IP20 / II  
> 953000 h (40°C)  
-25°C ... 70°C (> 55° C derating: 2.5%/K)

3 kV AC (routine test) / 4 kV AC (type test)  
Conformance with EMC Directive 2004/108/EC  
IEC 60950-1/VDE 0805 (SELV)  
EN 50178/VDE 0160 (PELV)  
DIN VDE 0100-410  
UL Listed UL 508, UL/C-UL Recognized UL 60950

EN 61000-3-2

Technical data

100 V AC ... 240 V AC  
85 V AC ... 264 V AC  
45 Hz ... 65 Hz  
1 A (120 V AC) / 0.6 A (230 V AC)  
< 30 A / < 0.5 A<sup>2</sup>s  
> 20 ms (120 V AC) / > 90 ms (230 V AC)

12 V DC ±1 %  
4.6 A  
Yes, with redundancy module / Yes  
< 0.3 W / < 8 W  
> 89% (for 230 V AC and nominal values)  
< 30 mV<sub>pp</sub>

LED

0.2 kg / 35 x 90 x 84 mm  
Alignable: 0 mm horizontally, 30 mm vertically  
Screw connection  
0.2 - 2.5 mm<sup>2</sup> / 0.2 - 2.5 mm<sup>2</sup> / 24 - 14  
IP20 / II  
> 865000 h (40°C)  
-25°C ... 70°C (> 55° C derating: 2.5%/K)

3 kV AC (routine test) / 4 kV AC (type test)  
Conformance with EMC Directive 2004/108/EC  
IEC 60950-1/VDE 0805 (SELV)  
EN 50178/VDE 0160 (PELV)  
DIN VDE 0100-410  
UL Listed UL 508, UL/C-UL Recognized UL 60950

EN 61000-3-2

Technical data

100 V AC ... 240 V AC  
85 V AC ... 264 V AC  
45 Hz ... 65 Hz  
1.7 A (120 V AC) / 1 A (230 V AC)  
< 30 A / < 1.5 A<sup>2</sup>s  
> 20 ms (120 V AC) / > 85 ms (230 V AC)

12 V DC ±1 %  
8.3 A  
Yes, with redundancy module / Yes  
< 0.4 W / < 12 W  
> 89.5%  
< 75 mV<sub>pp</sub>

LED

0.34 kg / 55 x 90 x 84 mm  
Alignable: 0 mm horizontally, 30 mm vertically  
Screw connection  
0.2 - 2.5 mm<sup>2</sup> / 0.2 - 2.5 mm<sup>2</sup> / 24 - 14  
IP20 / II  
> 500000 h (40°C)  
-25°C ... 70°C (> 55° C derating: 2.5%/K)

3 kV AC (routine test) / 4 kV AC (type test)  
Conformance with EMC Directive 2004/108/EC  
IEC 60950-1/VDE 0805 (SELV)  
EN 50178/VDE 0160 (PELV)  
DIN VDE 0100-410  
UL/C-UL listed UL 508, UL/C-UL Recognized UL 60950

EN 61000-3-2

Ordering data

Type	Order No.	Pcs. / Pkt.
UNO-PS/1AC/12DC/ 30W	2902998	1

Ordering data

Type	Order No.	Pcs. / Pkt.
UNO-PS/1AC/12DC/ 55W	2902999	1

Ordering data

Type	Order No.	Pcs. / Pkt.
UNO-PS/1AC/12DC/100W	2902997	1

# Power supplies and UPS

## Power supply units

### UNO POWER power supplies – compact with basic functionality

#### UNO POWER, 1 AC, 15 V DC, 24 V DC, and 48 V DC

- The wide range of products covers all common voltage levels
- Maximum energy efficiency: save energy thanks to high efficiency and extremely low idling losses
- Save space in the control cabinet thanks to extremely high power density
- Housing height of 84 mm, tailored to all popular 120 mm control boxes
- Wide temperature range from -25°C to +70°C



Power supply,  
1 AC, 5 DC, 25 W



Power supply,  
1 AC, 5 DC, 40 W

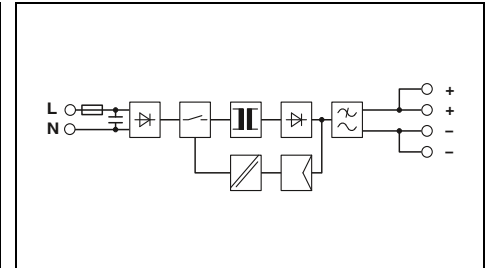
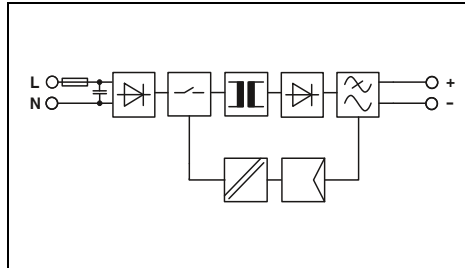

#### Technical data

#### Technical data

Input data	
Nominal input voltage range	100 V AC ... 240 V AC
Input voltage range	85 V AC ... 264 V AC
Frequency range	45 Hz ... 65 Hz
Current consumption (nominal load)	0.5 A (120 V AC) / 0.3 A (230 V AC)
Inrush current limitation at 25°C (typ.) / I <sup>2</sup> t	< 30 A / < 0.5 A <sup>2</sup> s
Mains buffering (I <sub>N</sub> , typ.)	> 35 ms (120 V AC) / > 135 ms (230 V AC)
Output data	
Nominal output voltage	5 V DC ±1 %
Output current	5 A
Can be connected in parallel / series	Yes, with redundancy module / Yes
Max. power dissipation (no load / nominal load)	< 0.3 W / < 4.5 W
Efficiency (typ.)	> 84%
Residual ripple	< 40 mV <sub>pp</sub>
Signaling	
Signaling DC OK	LED
General data	
Weight / Dimensions W x H x D	0.15 kg / 22.5 x 90 x 84 mm
Spacing when mounting	Alignable: 0 mm horizontally, 30 mm vertically
Connection method	Screw connection
Connection data solid / stranded / AWG	0.2 - 2.5 mm <sup>2</sup> / 0.2 - 2.5 mm <sup>2</sup> / 24 - 14
Degree of protection / Protection class	IP20 / II
MTBF (IEC 61709, SN 29500)	> 2174000 h (40°C)
Ambient temperature (operation)	-25°C ... 70°C (> 55° C derating: 2.5%/K)
Standards/regulations	
Insulation voltage input/output	3 kV AC (routine test) / 4 kV AC (type test)
Electromagnetic compatibility	Conformance with EMC Directive 2004/108/EC
Electrical safety	IEC 60950-1/VDE 0805 (SELV)
Electronic equipm. for electrical power installations	EN 50178/VDE 0160 (PELV)
Safe isolation	DIN VDE 0100-410
UL approvals	UL/C-UL listed UL 508, UL/C-UL Recognized UL 60950
Limitation of harmonic line currents	
	EN 61000-3-2

Technical data	
Nominal input voltage range	100 V AC ... 240 V AC
Input voltage range	85 V AC ... 264 V AC
Frequency range	45 Hz ... 65 Hz
Current consumption (nominal load)	0.5 A (120 V AC) / 0.3 A (230 V AC)
Inrush current limitation at 25°C (typ.) / I <sup>2</sup> t	< 30 A / < 0.5 A <sup>2</sup> s
Mains buffering (I <sub>N</sub> , typ.)	> 35 ms (120 V AC) / > 135 ms (230 V AC)
Output data	
Nominal output voltage	5 V DC ±1 %
Output current	8 A
Can be connected in parallel / series	Yes, with redundancy module / Yes
Max. power dissipation (no load / nominal load)	< 0.3 W / < 7.5 W
Efficiency (typ.)	> 85% (for 230 V AC and nominal values)
Residual ripple	< 100 mV <sub>pp</sub>
Signaling	
Signaling DC OK	LED
General data	
Weight / Dimensions W x H x D	0.21 kg / 35 x 90 x 84 mm
Spacing when mounting	Alignable: 0 mm horizontally, 30 mm vertically
Connection method	Screw connection
Connection data solid / stranded / AWG	0.2 - 2.5 mm <sup>2</sup> / 0.2 - 2.5 mm <sup>2</sup> / 24 - 14
Degree of protection / Protection class	IP20 / II
MTBF (IEC 61709, SN 29500)	> 1201000 h (40°C)
Ambient temperature (operation)	-25°C ... 70°C (> 55° C derating: 2.5%/K)
Standards/regulations	
Insulation voltage input/output	3 kV AC (routine test) / 4 kV AC (type test)
Electromagnetic compatibility	Conformance with EMC Directive 2004/108/EC
Electrical safety	IEC 60950-1/VDE 0805 (SELV)
Electronic equipm. for electrical power installations	EN 50178/VDE 0160 (PELV)
Safe isolation	DIN VDE 0100-410
UL approvals	UL/C-UL listed UL 508, UL/C-UL Recognized UL 60950
Limitation of harmonic line currents	
	EN 61000-3-2

Technical data	
Nominal input voltage range	100 V AC ... 240 V AC
Input voltage range	85 V AC ... 264 V AC
Frequency range	45 Hz ... 65 Hz
Current consumption (nominal load)	0.7 A (120 V AC) / 0.5 A (230 V AC)
Inrush current limitation at 25°C (typ.) / I <sup>2</sup> t	< 30 A / < 0.5 A <sup>2</sup> s
Mains buffering (I <sub>N</sub> , typ.)	> 30 ms (120 V AC) / > 120 ms (230 V AC)
Output data	
Nominal output voltage	5 V DC ±1 %
Output current	8 A
Can be connected in parallel / series	Yes, with redundancy module / Yes
Max. power dissipation (no load / nominal load)	< 0.3 W / < 7.5 W
Efficiency (typ.)	> 85% (for 230 V AC and nominal values)
Residual ripple	< 100 mV <sub>pp</sub>
Signaling	
Signaling DC OK	LED
General data	
Weight / Dimensions W x H x D	0.21 kg / 35 x 90 x 84 mm
Spacing when mounting	Alignable: 0 mm horizontally, 30 mm vertically
Connection method	Screw connection
Connection data solid / stranded / AWG	0.2 - 2.5 mm <sup>2</sup> / 0.2 - 2.5 mm <sup>2</sup> / 24 - 14
Degree of protection / Protection class	IP20 / II
MTBF (IEC 61709, SN 29500)	> 1201000 h (40°C)
Ambient temperature (operation)	-25°C ... 70°C (> 55° C derating: 2.5%/K)
Standards/regulations	
Insulation voltage input/output	3 kV AC (routine test) / 4 kV AC (type test)
Electromagnetic compatibility	Conformance with EMC Directive 2004/108/EC
Electrical safety	IEC 60950-1/VDE 0805 (SELV)
Electronic equipm. for electrical power installations	EN 50178/VDE 0160 (PELV)
Safe isolation	DIN VDE 0100-410
UL approvals	UL/C-UL listed UL 508, UL/C-UL Recognized UL 60950
Limitation of harmonic line currents	
	EN 61000-3-2

#### Ordering data

#### Ordering data

Description	Type	Order No.	Pcs. / Pkt.
Power supply, primary-switched	UNO-PS/1AC/ 5DC/ 25W	2904374	1

Description	Type	Order No.	Pcs. / Pkt.
Power supply, primary-switched	UNO-PS/1AC/ 5DC/ 25W	2904374	1

Description	Type	Order No.	Pcs. / Pkt.
Power supply, primary-switched	UNO-PS/1AC/ 5DC/ 40W	2904375	1



Power supply,  
1 AC, 15 DC, 30 W



Power supply,  
1 AC, 15 DC, 55 W



Power supply,  
1 AC, 15 DC, 100 W

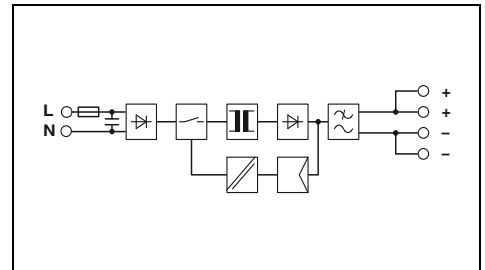
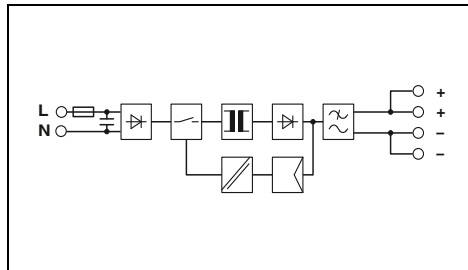
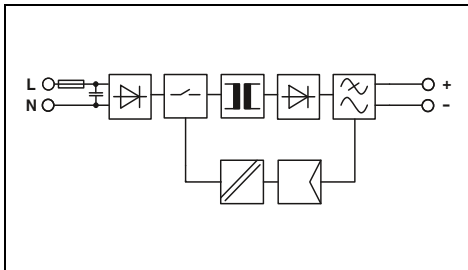

Technical data

100 V AC ... 240 V AC  
85 V AC ... 264 V AC  
45 Hz ... 65 Hz  
0.6 A (120 V AC) / 0.4 A (230 V AC)  
< 30 A / < 0.3 A<sup>2</sup>s  
> 20 ms (120 V AC) / > 115 ms (230 V AC)

15 V DC ±1 %  
2 A  
Yes, with redundancy module / Yes  
< 0.3 W / < 4.6 W  
> 87% (for 230 V AC and nominal values)  
< 40 mV<sub>pp</sub>

LED

0.15 kg / 22.5 x 90 x 84 mm  
Alignable: 0 mm horizontally, 30 mm vertically  
Screw connection  
0.2 - 2.5 mm<sup>2</sup> / 0.2 - 2.5 mm<sup>2</sup> / 24 - 14  
IP20 / II  
> 911000 h (40°C)  
-25°C ... 70°C (> 55° C derating: 2.5%/K)

3 kV AC (routine test) / 4 kV AC (type test)  
Conformance with EMC Directive 2004/108/EC  
IEC 60950-1/VDE 0805 (SELV)  
EN 50178/VDE 0160 (PELV)  
DIN VDE 0100-410  
UL/C-UL listed UL 508, UL/C-UL Recognized UL 60950

EN 61000-3-2

Ordering data

Type	Order No.	Pcs. / Pkt.
UNO-PS/1AC/15DC/30W	2903000	1

Technical data

100 V AC ... 240 V AC  
85 V AC ... 264 V AC  
45 Hz ... 65 Hz  
1 A (120 V AC) / 0.6 A (230 V AC)  
< 25 A / < 0.5 A<sup>2</sup>s  
> 25 ms (120 V AC) / > 90 ms (230 V AC)

15 V DC ±1 %  
3.7 A  
Yes, with redundancy module / Yes  
< 0.3 W / < 7 W  
> 88.5% (for 230 V AC and nominal values)  
< 50 mV<sub>pp</sub>

LED

0.21 kg / 35 x 90 x 84 mm  
Alignable: 0 mm horizontally, 30 mm vertically  
Screw connection  
0.2 - 2.5 mm<sup>2</sup> / 0.2 - 2.5 mm<sup>2</sup> / 24 - 14  
IP20 / II  
> 647000 h (40°C)  
-25°C ... 70°C (> 55° C derating: 2.5%/K)

3 kV AC (routine test) / 4 kV AC (type test)  
Conformance with EMC Directive 2004/108/EC  
IEC 60950-1/VDE 0805 (SELV)  
EN 50178/VDE 0160 (PELV)  
DIN VDE 0100-410  
UL/C-UL listed UL 508, UL/C-UL Recognized UL 60950

EN 61000-3-2

Ordering data

Type	Order No.	Pcs. / Pkt.
UNO-PS/1AC/15DC/55W	2903001	1

Technical data

100 V AC ... 240 V AC  
85 V AC ... 264 V AC  
45 Hz ... 65 Hz  
1.7 A (120 V AC) / 1 A (230 V AC)  
< 30 A / < 1.5 A<sup>2</sup>s  
> 20 ms (120 V AC) / > 85 ms (230 V AC)

15 V DC ±1 %  
6.67 A  
Yes, with redundancy module / Yes  
< 0.4 W / < 12 W  
> 89% (for 230 V AC and nominal values)  
< 75 mV<sub>pp</sub>

LED

0.34 kg / 55 x 90 x 84 mm  
Alignable: 0 mm horizontally, 30 mm vertically  
Screw connection  
0.2 - 2.5 mm<sup>2</sup> / 0.2 - 2.5 mm<sup>2</sup> / 24 - 14  
IP20 / II  
> 727000 h (40°C)  
-25°C ... 70°C (> 55° C derating: 2.5%/K)

3 kV AC (routine test) / 4 kV AC (type test)  
Conformance with EMC Directive 2004/108/EC  
IEC 60950-1/VDE 0805 (SELV)  
EN 50178/VDE 0160 (PELV)  
DIN VDE 0100-410  
UL/C-UL listed UL 508, UL/C-UL Recognized UL 60950

EN 61000-3-2

Ordering data

Type	Order No.	Pcs. / Pkt.
UNO-PS/1AC/15DC/100W	2903002	1

# Power supplies and UPS

## Power supply units

### UNO POWER power supplies – compact with basic functionality

#### UNO POWER, 1 AC, 24 V DC

- The wide range of products covers all common voltage levels
- Maximum energy efficiency: save energy thanks to high efficiency and extremely low idling losses
- Save space in the control cabinet thanks to extremely high power density
- Wide temperature range from -25°C to +70°C



Power supply,  
1 AC, 48 DC, 60 W



Power supply,  
1 AC, 48 DC, 100 W

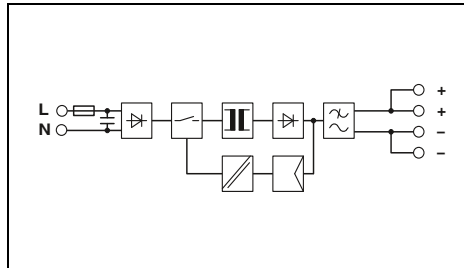

#### Technical data

Input data
Nominal input voltage range
Input voltage range
Frequency range
Current consumption (nominal load)
Inrush current limitation at 25°C (typ.) / I <sup>2</sup> t
Mains buffering (I <sub>N</sub> , typ.)
Output data
Nominal output voltage
Output current
Can be connected in parallel / series
Max. power dissipation (no load / nominal load)
Efficiency (typ.)
Residual ripple
Signaling
Signaling DC OK
General data
Weight / Dimensions W x H x D
Spacing when mounting
Connection method
Connection data solid / stranded / AWG
Degree of protection / Protection class
MTBF (IEC 61709, SN 29500)
Ambient temperature (operation)
Standards/regulations
Insulation voltage input/output
Electromagnetic compatibility
Electrical safety
Electronic equipm. for electrical power installations
Safe isolation
UL approvals
Limitation of harmonic line currents

100 V AC ... 240 V AC
85 V AC ... 264 V AC
45 Hz ... 65 Hz
1 A (120 V AC) / 0.6 A (230 V AC)
< 30 A / < 0.5 A <sup>2</sup> s
> 20 ms (120 V AC) / > 90 ms (230 V AC)
48 V DC ±1 %
1.25 A
Yes, with redundancy module / Yes
< 0.4 W / < 7 W
> 90% (for 230 V AC and nominal values)
< 35 mV <sub>pp</sub>
LED
0.21 kg / 35 x 90 x 84 mm
Alignable: 0 mm horizontally, 30 mm vertically
Screw connection
0.2 - 2.5 mm <sup>2</sup> / 0.2 - 2.5 mm <sup>2</sup> / 24 - 14
IP20 / II
> 1138000 h (40°C)
-25°C ... 70°C (> 55° C derating: 2.5%/K)
3 kV AC (routine test) / 4 kV AC (type test)
Conformance with EMC Directive 2004/108/EC
IEC 60950-1/VDE 0805 (SELV)
EN 50178/VDE 0160 (PELV)
DIN VDE 0100-410
UL/C-UL listed UL 508, UL/C-UL Recognized UL 60950
EN 61000-3-2

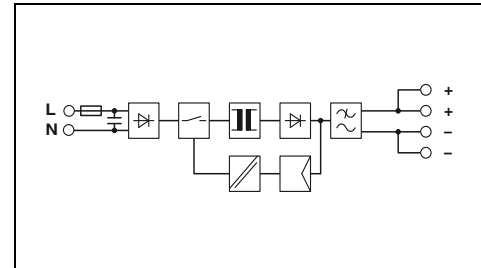

#### Technical data

100 V AC ... 240 V AC
85 V AC ... 264 V AC
45 Hz ... 65 Hz
1.7 A (120 V AC) / 1 A (230 V AC)
< 40 A / < 1.4 A <sup>2</sup> s
> 25 ms (120 V AC) / > 90 ms (230 V AC)
48 V DC ±1 %
2.1 A
Yes, with redundancy module / Yes
< 0.4 W / < 11 W
> 90% (for 230 V AC and nominal values)
< 40 mV <sub>pp</sub>
LED
0.34 kg / 55 x 90 x 84 mm
Alignable: 0 mm horizontally, 30 mm vertically
Screw connection
0.2 - 2.5 mm <sup>2</sup> / 0.2 - 2.5 mm <sup>2</sup> / 24 - 14
IP20 / II
> 1010000 h (40°C)
-25°C ... 70°C (> 55° C derating: 2.5%/K)
3 kV AC (routine test) / 4 kV AC (type test)
Conformance with EMC Directive 2004/108/EC
IEC 60950-1/VDE 0805 (SELV)
EN 50178/VDE 0160 (PELV)
DIN VDE 0100-410
UL/C-UL listed UL 508, UL/C-UL Recognized UL 60950
EN 61000-3-2

#### Ordering data

Description	Type	Order No.	Pcs. / Pkt.
Power supply, primary-switched	UNO-PS/1AC/48DC/ 60W	2902995	1

#### Ordering data

Description	Type	Order No.	Pcs. / Pkt.
Power supply, primary-switched	UNO-PS/1AC/48DC/100W	2902996	1



# Power supplies and UPS

## Power supply units

### MINI POWER power supply units - for measurement and control technology

#### MINI POWER, 1 AC, 24 V DC

- Easy-to-maintain connection method thanks to keyed COMBICON connector
- Remote monitoring of output voltage via switching output

#### MINI POWER, NEC Class 2

- Output power limited to 100 W: Specifically for applications that require certification according to UL 1310/508 Listed Class 2



**Power supply,  
1 AC, 24 V DC, 1.3 A  
NEC Class 2**

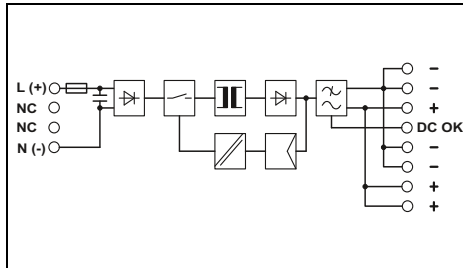

#### Technical data

<b>Input data</b>	
Nominal input voltage range	100 V AC ... 240 V AC
Input voltage range	85 V AC ... 264 V AC / 90 V DC ... 350 V DC
Frequency range	45 Hz ... 65 Hz
Current consumption (nominal load)	0.65 A (120 V AC) / 0.25 A (230 V AC)
Inrush current limitation at 25°C (typ.) / I <sup>2</sup> t	< 15 A / 0.6 A <sup>2</sup> s
Mains buffering (I <sub>N</sub> , typ.)	> 20 ms (120 V AC) / > 110 ms (230 V AC)
<b>Output data</b>	
Nominal output voltage	24 V DC ±1 %
Setting range of the output voltage	22.5 V DC ... 28.5 V DC (> 24 V constant capacity)
<b>Output current / POWER BOOST</b>	1.3 A / 1.6 A
Can be connected in parallel / series	Yes / Yes
Max. power dissipation (no load / nominal load)	0.9 W / 4.5 W
Efficiency (typ.)	> 85% (for 230 V AC and nominal values)
Residual ripple	< 20 mV <sub>pp</sub>
<b>Signaling</b>	
Signaling DC OK	LED, active switching output
<b>General data</b>	
Weight / Dimensions W x H x D	0.2 kg / 22.5 x 99 x 107 mm
Spacing when mounting	Alignable: horizontally 0 mm, vertically 50 mm
Connection method	Plug-in screw connection
Connection data solid / stranded / AWG	0.2 - 2.5 mm <sup>2</sup> / 0.2 - 2.5 mm <sup>2</sup> / 24 - 12
Degree of protection / Protection class	IP20 / II
MTBF (IEC 61709, SN 29500)	> 1104000 h (40°C)
Ambient temperature (operation)	-25°C ... 70°C (> 60°C derating: 2.5%/K)
<b>Standards/regulations</b>	
Insulation voltage input/output	3 kV (routine test) / 4 kV (type test)
Electromagnetic compatibility	Conformance with EMC Directive 2004/108/EC
Electrical safety	EN 60950-1/VDE 0805 (SELV)
Electronic equipm. for electrical power installations	EN 50178/VDE 0160 (PELV)
Safe isolation	DIN VDE 0100-410
UL approvals	UL/C-UL listed UL 508, UL/C-UL Recognized UL 60950, UL ANSI/ISA-12.12.01 Class I, Division 2, Groups A, B, C, D (Hazardous Location), NEC Class 2 as per UL 1310
<b>Limitation of harmonic line currents</b>	EN 61000-3-2

#### Ordering data

Description	Type	Order No.	Pcs. / Pkt.
<b>Power supply, primary-switched</b>	MINI-PS-100-240AC/24DC/1.3	2866446	1

#### Accessories

<b>DIN rail connector</b> (optional), for routing through the supply voltage and data signal, two pieces are required per device			
----------------------------------------------------------------------------------------------------------------------------------	--	--	--



**Power supply,  
1 AC, 24 V DC, 1.5 A,  
DIN rail connector optional**

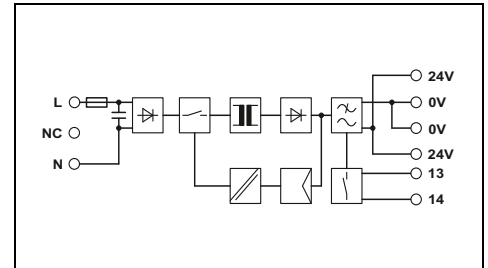

#### Technical data

<b>Input data</b>	
Nominal input voltage range	100 V AC ... 240 V AC
Input voltage range	85 V AC ... 264 V AC
Frequency range	45 Hz ... 65 Hz
Current consumption (nominal load)	0.75 A (120 V AC) / 0.45 A (230 V AC)
Inrush current limitation at 25°C (typ.) / I <sup>2</sup> t	< 15 A / 0.6 A <sup>2</sup> s
Mains buffering (I <sub>N</sub> , typ.)	> 35 ms (120 V AC) / > 150 ms (230 V AC)
<b>Output data</b>	
Nominal output voltage	24 V DC ±1 %
Setting range of the output voltage	-
<b>Output current / POWER BOOST</b>	1.5 A / 2 A
Can be connected in parallel / series	Yes / No
Max. power dissipation (no load / nominal load)	1.5 W / 6.5 W
Efficiency (typ.)	> 84% (for 230 V AC and nominal values)
Residual ripple	< 40 mV <sub>pp</sub>
<b>Signaling</b>	
Signaling DC OK	LED, relay contact
<b>General data</b>	
Weight / Dimensions W x H x D	0.25 kg / 35 x 99 x 95 mm
Spacing when mounting	Alignable: horizontally 0 mm, vertically 50 mm
Connection method	Plug-in screw connection
Connection data solid / stranded / AWG	0.2 - 2.5 mm <sup>2</sup> / 0.2 - 2.5 mm <sup>2</sup> / 24 - 12
Degree of protection / Protection class	IP20 / II
MTBF (IEC 61709, SN 29500)	> 2789000 h (40°C)
Ambient temperature (operation)	-25°C ... 70°C (> 60°C derating: 2.5%/K)
<b>Standards/regulations</b>	
Insulation voltage input/output	3 kV (routine test) / 4 kV (type test)
Electromagnetic compatibility	Conformance with EMC Directive 2004/108/EC
Electrical safety	EN 60950-1/VDE 0805 (SELV)
Electronic equipm. for electrical power installations	EN 50178/VDE 0160 (PELV)
Safe isolation	DIN VDE 0100-410
UL approvals	UL/C-UL listed UL 508, UL/C-UL Recognized UL 60950, UL ANSI/ISA-12.12.01 Class I, Division 2, Groups A, B, C, D (Hazardous Location)
<b>Limitation of harmonic line currents</b>	EN 61000-3-2

#### Ordering data

Description	Type	Order No.	Pcs. / Pkt.
<b>Power supply, primary-switched</b>	MINI-SYS-PS-100-240AC/24DC/1.5	2866983	1

#### Accessories

<b>DIN rail connector</b> (optional), for routing through the supply voltage and data signal, two pieces are required per device			
<b>ME 17.5 TBUS 1,5/5-ST-3,81 GN</b>	2709561	10	



Power supply,  
1 AC, 24 V DC, 2 A  
NEC Class 2



Power supply,  
1 AC, 24 V DC, 100 W  
NEC Class 2



Power supply,  
1 AC, 24 V DC, 4 A

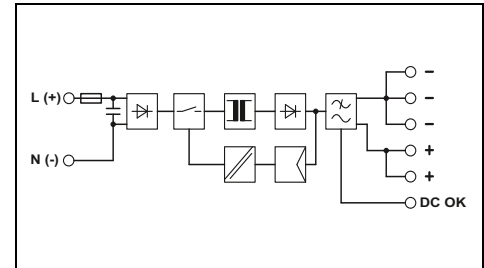
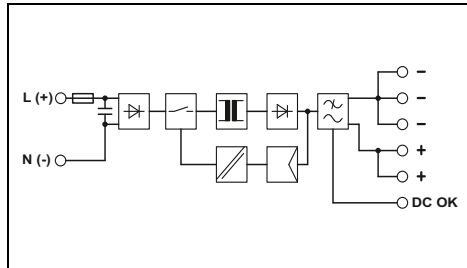
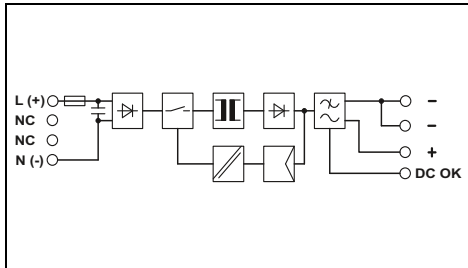

Technical data

100 V AC ... 240 V AC  
85 V AC ... 264 V AC / 90 V DC ... 350 V DC  
45 Hz ... 65 Hz  
0.7 A (120 V AC) / 0.4 A (230 V AC)  
< 15 A / 4.1 A<sup>2</sup>s  
> 35 ms (120 V AC) / > 170 ms (230 V AC)

24 V DC ±1 %  
22.5 V DC ... 28.5 V DC (> 24 V constant capacity)

2 A / 2.9 A  
Yes / Yes  
2 W / 7 W  
> 88% (for 230 V AC and nominal values)  
< 20 mV<sub>PP</sub>

LED, active switching output

0.25 kg / 45 x 99 x 107 mm  
Alignable: horizontally 0 mm, vertically 50 mm  
Plug-in screw connection  
0.2 - 2.5 mm<sup>2</sup> / 0.2 - 2.5 mm<sup>2</sup> / 24 - 12  
IP20 / II  
> 507000 h (40°C)  
-25°C ... 70°C (> 60°C derating: 2.5%/K)

3 kV (routine test) / 4 kV (type test)  
Conformance with EMC Directive 2004/108/EC  
EN 60950-1/VDE 0805 (SELV)  
EN 50178/VDE 0160 (PELV)  
DIN VDE 0100-410  
UL/C-UL listed UL 508, UL/C-UL Recognized UL 60950,  
UL ANSI/ISA-12.12.01 Class I, Division 2, Groups A, B, C, D  
(Hazardous Location), NEC Class 2 as per UL 1310

EN 61000-3-2

Ordering data

Type	Order No.	Pcs. / Pkt.
MINI-PS-100-240AC/24DC/2	2938730	1

Accessories

Technical data

100 V AC ... 240 V AC  
85 V AC ... 264 V AC / 90 V DC ... 350 V DC  
45 Hz ... 65 Hz  
1.3 A (120 V AC) / 0.8 A (230 V AC)  
< 15 A / 2.1 A<sup>2</sup>s  
> 20 ms (120 V AC) / > 100 ms (230 V AC)

24 V DC ±1 %  
22.5 V DC ... 26 V DC (> 24 V constant capacity)

3.8 A  
Yes / Yes  
2.5 W / 12 W  
> 88% (for 230 V AC and nominal values)  
< 40 mV<sub>PP</sub>

LED, active switching output

0.4 kg / 67.5 x 99 x 107 mm  
Alignable: horizontally 0 mm, vertically 50 mm  
Plug-in screw connection  
0.2 - 2.5 mm<sup>2</sup> / 0.2 - 2.5 mm<sup>2</sup> / 24 - 12  
IP20 / II  
> 815000 h (40°C)  
-25°C ... 70°C (> 60°C derating: 2.5%/K)

3 kV (routine test) / 3 kV (type test)  
Conformance with EMC Directive 2004/108/EC  
EN 60950-1/VDE 0805 (SELV)  
EN 50178/VDE 0160 (PELV)  
DIN VDE 0100-410  
UL/C-UL listed UL 508, UL/C-UL Recognized UL 60950,  
UL ANSI/ISA-12.12.01 Class I, Division 2, Groups A, B, C, D  
(Hazardous Location), NEC Class 2 as per UL 1310

EN 61000-3-2

Ordering data

Type	Order No.	Pcs. / Pkt.
MINI-PS-100-240AC/24DC/C2LPS	2866336	1

Accessories

Technical data

100 V AC ... 240 V AC  
85 V AC ... 264 V AC / 90 V DC ... 350 V DC  
45 Hz ... 65 Hz  
1.3 A (120 V AC) / 0.8 A (230 V AC)  
< 15 A / 2.1 A<sup>2</sup>s  
> 20 ms (120 V AC) / > 100 ms (230 V AC)

24 V DC ±1 %  
22.5 V DC ... 28.5 V DC (> 24 V constant capacity)

4 A / 5 A  
Yes / Yes  
2.5 W / 12 W  
> 88% (for 230 V AC and nominal values)  
< 20 mV<sub>PP</sub>

LED, active switching output

0.4 kg / 67.5 x 99 x 107 mm  
Alignable: horizontally 0 mm, vertically 50 mm  
Plug-in screw connection  
0.2 - 2.5 mm<sup>2</sup> / 0.2 - 2.5 mm<sup>2</sup> / 24 - 12  
IP20 / II  
> 815000 h (40°C)  
-25°C ... 70°C (> 60°C derating: 2.5%/K)

3 kV (routine test) / 3 kV (type test)  
Conformance with EMC Directive 2004/108/EC  
EN 60950-1/VDE 0805 (SELV)  
EN 50178/VDE 0160 (PELV)  
DIN VDE 0100-410  
UL/C-UL listed UL 508, UL/C-UL Recognized UL 60950,  
UL ANSI/ISA-12.12.01 Class I, Division 2, Groups A, B, C, D  
(Hazardous Location)

EN 61000-3-2

Ordering data

Type	Order No.	Pcs. / Pkt.
MINI-PS-100-240AC/24DC/4	2938837	1

Accessories

# Power supplies and UPS

## Power supply units

### MINI POWER power supply units - for measurement and control technology

#### MINI POWER, 1 AC, 5 to 15 V DC

- Easy-to-maintain connection method thanks to keyed COMBICON connector
- Remote monitoring of output voltage via switching output

#### MINI POWER, ±15 V DC

- For supplying operational amplifiers

#### MINI POWER EX

Corresponds to standard EN 60079-15

- Installation in a potentially explosive area in which category 3G equipment is required (zone 2).

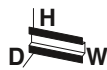

Power supply,  
1 AC, 5 V DC, 3 A

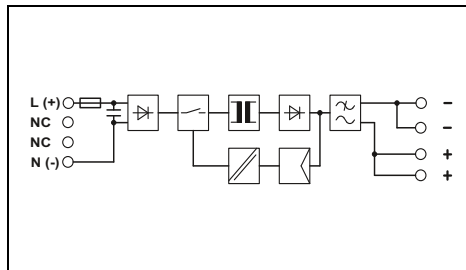

Power supply,  
1 AC, 10 - 15 V DC, 2 A

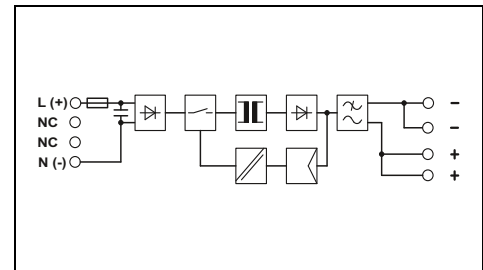

Input data	
Nominal input voltage range	100 V AC ... 240 V AC
Input voltage range	85 V AC ... 264 V AC / 90 V DC ... 350 V DC
Frequency range	45 Hz ... 65 Hz
Current consumption (nominal load)	0.4 A (120 V AC) / 0.2 A (230 V AC)
Inrush current limitation at 25°C (typ.) / I <sup>2</sup> t	< 15 A / 1.5 A <sup>2</sup> s
Mains buffering (I <sub>N</sub> , typ.)	> 30 ms (120 V AC) / > 140 ms (230 V AC)
Output data	
Nominal output voltage	5 V DC ±1 %
Setting range of the output voltage	4.5 V DC ... 5.5 V DC (> 5 V constant capacity)
Output current / POWER BOOST	3 A / 5 A
Can be connected in parallel / series	Yes / Yes
Max. power dissipation (no load / nominal load)	1 W / 5 W
Efficiency (typ.)	> 73% (for 230 V AC and nominal values)
Residual ripple	< 40 mV <sub>pp</sub>
Signaling	LED
Signaling DC OK	
General data	
Weight / Dimensions W x H x D	0.17 kg / 22.5 x 99 x 107 mm
Spacing when mounting	Alignable: horizontally 0 mm, vertically 50 mm
Connection method	Plug-in screw connection
Connection data solid / stranded / AWG	0.2 - 2.5 mm <sup>2</sup> / 0.2 - 2.5 mm <sup>2</sup> / 24 - 12
Degree of protection / Protection class	IP20 / II
MTBF (IEC 61709, SN 29500)	> 766000 h (40°C)
Ambient temperature (operation)	-25°C ... 70°C (> 60°C derating: 2.5%/K)
Standards/regulations	
Insulation voltage input/output	3 kV (routine test) / 4 kV (type test)
Electromagnetic compatibility	Conformance with EMC Directive 2004/108/EC
Electrical safety	EN 60950-1/VDE 0805 (SELV)
Electronic eqpm. for electrical power installations	EN 50178/VDE 0160 (PELV)
Safe isolation	DIN VDE 0100-410
UL approvals	UL/C-UL listed UL 508, UL/C-UL Recognized UL 60950, UL ANSI/ISA-12.12.01 Class I, Division 2, Groups A, B, C, D (Hazardous Location)
Limitation of harmonic line currents	EN 61000-3-2

Technical data		
100 V AC ... 240 V AC		
85 V AC ... 264 V AC / 90 V DC ... 350 V DC		
45 Hz ... 65 Hz		
0.4 A (120 V AC) / 0.2 A (230 V AC)		
< 15 A / 1.5 A <sup>2</sup> s		
> 30 ms (120 V AC) / > 140 ms (230 V AC)		
5 V DC ±1 %		
4.5 V DC ... 5.5 V DC (> 5 V constant capacity)		
3 A / 5 A		
Yes / Yes		
1 W / 5 W		
> 73% (for 230 V AC and nominal values)		
< 40 mV <sub>pp</sub>		
LED		
0.17 kg / 22.5 x 99 x 107 mm		
Alignable: horizontally 0 mm, vertically 50 mm		
Plug-in screw connection		
0.2 - 2.5 mm <sup>2</sup> / 0.2 - 2.5 mm <sup>2</sup> / 24 - 12		
IP20 / II		
> 766000 h (40°C)		
-25°C ... 70°C (> 60°C derating: 2.5%/K)		
3 kV (routine test) / 4 kV (type test)		
Conformance with EMC Directive 2004/108/EC		
EN 60950-1/VDE 0805 (SELV)		
EN 50178/VDE 0160 (PELV)		
DIN VDE 0100-410		
UL/C-UL listed UL 508, UL/C-UL Recognized UL 60950, UL ANSI/ISA-12.12.01 Class I, Division 2, Groups A, B, C, D (Hazardous Location)		
EN 61000-3-2		

Technical data		
100 V AC ... 240 V AC		
85 V AC ... 264 V AC / 90 V DC ... 350 V DC		
45 Hz ... 65 Hz		
0.4 A (120 V AC) / 0.2 A (230 V AC)		
< 15 A / 1.7 A <sup>2</sup> s		
> 20 ms (120 V AC) / > 120 ms (230 V AC)		
12 V DC ±1 %		
10 V DC ... 15 V DC (> 12 V constant capacity)		
2 A / 2.3 A		
Yes / Yes		
< 1 W / < 7 W		
> 86% (for 230 V AC and nominal values)		
< 20 mV <sub>pp</sub>		
LED		
0.25 kg / 45 x 99 x 107 mm		
Alignable: horizontally 0 mm, vertically 50 mm		
Plug-in screw connection		
0.2 - 2.5 mm <sup>2</sup> / 0.2 - 2.5 mm <sup>2</sup> / 24 - 12		
IP20 / II		
> 507000 h (40°C)		
-25°C ... 70°C (> 60°C derating: 2.5%/K)		
3 kV (routine test) / 4 kV (type test)		
Conformance with EMC Directive 2004/108/EC		
EN 60950-1/VDE 0805 (SELV)		
EN 50178/VDE 0160 (PELV)		
DIN VDE 0100-410		
UL/C-UL listed UL 508, UL/C-UL Recognized UL 60950, UL ANSI/ISA-12.12.01 Class I, Division 2, Groups A, B, C, D (Hazardous Location)		
EN 61000-3-2		

Ordering data			
Description	Type	Order No.	Pcs. / Pkt.
Power supply, primary-switched	MINI-PS-100-240AC/ 5DC/3	2938714	1
Accessories			
DIN rail connector (optional), for routing through the supply voltage and data signal, two pieces are required per device			

Ordering data		
Type	Order No.	Pcs. / Pkt.
MINI-PS-100-240AC/ 5DC/3	2938714	1
Accessories		
DIN rail connector (optional), for routing through the supply voltage and data signal, two pieces are required per device		

Ordering data		
Type	Order No.	Pcs. / Pkt.
MINI-PS-100-240AC/10-15DC/2	2938756	1
Accessories		
DIN rail connector (optional), for routing through the supply voltage and data signal, two pieces are required per device		



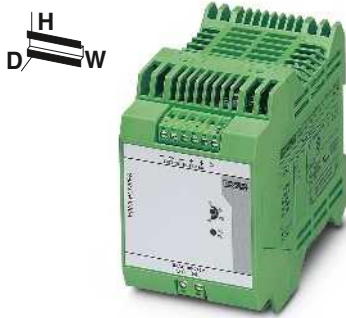

Power supply,  
1 AC, 10 - 15 V DC, 8 A

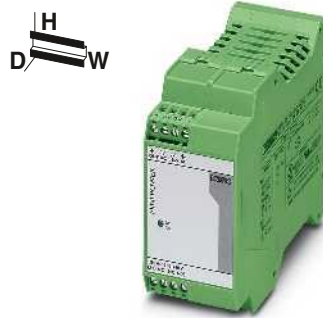

Power supply,  
1 AC, ±15 V DC, 1 A  
NEC Class 2



Power supply  
1 AC, 24 DC, 1.5 A  
DIN rail connector optional

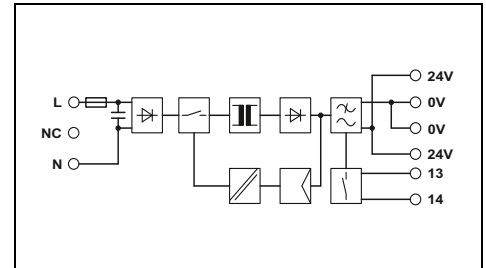
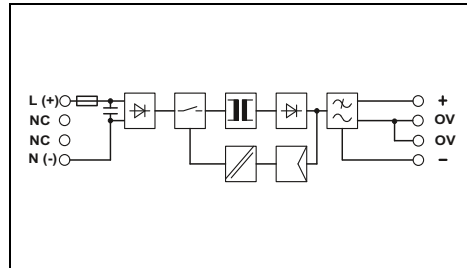
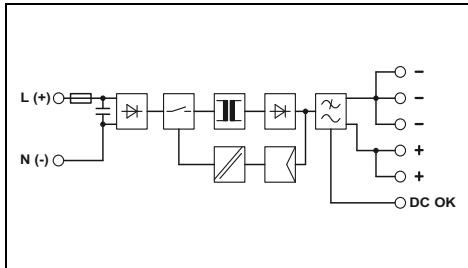

Technical data
100 V AC ... 240 V AC 85 V AC ... 264 V AC / 90 V DC ... 350 V DC 45 Hz ... 65 Hz 1.3 A (120 V AC) / 0.8 A (230 V AC) < 15 A / 2.1 A <sup>2</sup> s > 20 ms (120 V AC) / > 20 ms (230 V AC)
12 V DC ±1 % 10 V DC ... 15 V DC (> 12 V constant capacity)
8 A / 6.6 A Yes / Yes < 2.5 W / < 12 W > 88% (for 230 V AC and nominal values) < 40 mV <sub>PP</sub>
LED, active switching output
0.4 kg / 67.5 x 99 x 107 mm Alignable: horizontally 0 mm, vertically 50 mm Plug-in screw connection 0.2 - 2.5 mm <sup>2</sup> / 0.2 - 2.5 mm <sup>2</sup> / 24 - 12 IP20 / II > 984000 h (40°C) -25°C ... 70°C (> 60°C derating: 2.5%/K)
3 kV (routine test) / 3 kV (type test) Conformance with EMC Directive 2004/108/EC EN 60950-1/VDE 0805 (SELV) EN 50178/VDE 0160 (PELV) DIN VDE 0100-410 UL/C-UL listed UL 508, UL/C-UL Recognized UL 60950, UL ANSI/ISA-12.12.01 Class I, Division 2, Groups A, B, C, D (Hazardous Location)
EN 61000-3-2

Technical data
100 V AC ... 240 V AC 85 V AC ... 264 V AC / 90 V DC ... 350 V DC 45 Hz ... 65 Hz 0.6 A (120 V AC) / 0.4 A (230 V AC) < 35 A / 4 A <sup>2</sup> s > 30 ms (120 V AC) / > 150 ms (230 V AC)
± 15 V DC ±1 % -
1 A / 1.5 A Yes / Yes 2 W / 8 W > 80% (for 230 V AC and nominal values) < 30 mV <sub>PP</sub>
LED
0.25 kg / 45 x 99 x 107 mm Alignable: horizontally 0 mm, vertically 50 mm Plug-in screw connection 0.2 - 2.5 mm <sup>2</sup> / 0.2 - 2.5 mm <sup>2</sup> / 24 - 12 IP20 / II > 500000 h (40°C) -25°C ... 70°C (> 60°C derating: 2.5%/K)
3 kV (routine test) / 4 kV (type test) Conformance with EMC Directive 2004/108/EC EN 60950-1/VDE 0805 (SELV) EN 50178/VDE 0160 (PELV) DIN VDE 0100-410 UL/C-UL listed UL 508, UL/C-UL Recognized UL 60950, UL ANSI/ISA-12.12.01 Class I, Division 2, Groups A, B, C, D (Hazardous Location), NEC Class 2 as per UL 1310
EN 61000-3-2

Technical data
100 V AC ... 240 V AC 85 V AC ... 264 V AC / - 45 Hz ... 65 Hz 0.75 A (120 V AC) / 0.45 A (230 V AC) < 15 A / 0.6 A <sup>2</sup> s > 35 ms (120 V AC) / > 150 ms (230 V AC)
24 V DC ±1 % -
1.5 A / 2 A Yes / Yes 1.5 W / 6.5 W > 84% (for 230 V AC and nominal values) < 40 mV <sub>PP</sub>
LED, relay contact
0.25 kg / 35 x 99 x 95 mm Alignable: horizontally 0 mm, vertically 50 mm Plug-in screw connection 0.2 - 2.5 mm <sup>2</sup> / 0.2 - 2.5 mm <sup>2</sup> / 24 - 12 IP20 / II > 2789000 h (40°C) -25°C ... 70°C (> 60°C derating: 2.5%/K)
3 kV AC (routine test) / 4 kV AC (type test) Conformance with EMC Directive 2004/108/EC EN 60950-1/VDE 0805 (SELV) EN 50178/VDE 0160 (PELV) DIN VDE 0100-410 UL/C-UL listed UL 508, UL/C-UL Recognized UL 60950, UL ANSI/ISA-12.12.01 Class I, Division 2, Groups A, B, C, D (Hazardous Location)
EN 61000-3-2

Ordering data		
Type	Order No.	Pcs. / Pkt.
MINI-PS-100-240AC/10-15DC/8	2866297	1

Ordering data		
Type	Order No.	Pcs. / Pkt.
MINI-PS-100-240AC/2X15DC/1	2938743	1

Ordering data		
Type	Order No.	Pcs. / Pkt.
MINI-PS-100-240AC/24DC/1.5/EX	2866653	1

Accessories		

Accessories		

Accessories		
ME 17,5 TBUS 1,5/ 5-ST-3,81 GN	2709561	10

# Power supplies and UPS

## Power supply units

### STEP POWER - power supply units for distributor boards and flat control panels

#### STEP POWER, 1 AC, 24 V DC

- Flexible assembly by simply snapping the product onto the DIN rail or screwing it onto an even surface
- Energy savings thanks to maximum energy efficiency and incredibly low no-load losses
- Wide temperature range from -25°C to +70°C
- Reliable supply thanks to the high MTBF (mean time between failure)

#### STEP POWER, 24 V DC, 0.5 A

- Slim design with an overall width of just 18 mm (1 pitch)

#### STEP POWER, 24 V DC, 0.75 A

- Meets standard EN 60335-1 for household appliances, suitable for installation in ventilation systems, for example
- Flat design with a depth of just 43 mm

#### STEP POWER, 48 V AC, 0.5 A

- Connection to 48 V AC operating networks
- Slim design with an overall width of just 18 mm (1 pitch)



Power supply,  
1 AC, 24 V DC, 0.5 A  
NEC Class 2

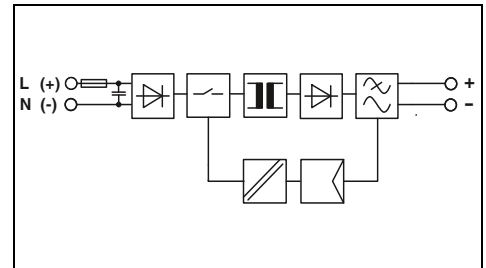

### Technical data

Input data	100 V AC ... 240 V AC 85 V AC ... 264 V AC / 95 V DC ... 250 V DC 45 Hz ... 65 Hz / 0 Hz 0.28 A (120 V AC) / 0.13 A (230 V AC) < 15 A / < 0.1 A <sup>2</sup> s > 15 ms (120 V AC) / > 90 ms (230 V AC)
Output data	24 V DC ±1 % 0.5 A Yes / Yes < 0.3 W / < 2.2 W > 84% (for 230 V AC and nominal values) < 20 mV <sub>pp</sub>
Signaling	LED
General data	0.07 kg / 18 x 90 x 61 mm Alignable: 0 mm horizontally, 30 mm vertically Screw connection 0.2 - 2.5 mm <sup>2</sup> / 0.2 - 2.5 mm <sup>2</sup> / 24 - 12 IP20 / II > 1567000 h (40°C) -25°C ... 70°C (> 55°C derating: 2.5%/K)
Standards/regulations	3.75 kV AC (routine test) / 4 kV AC (type test) Conformance with EMC Directive 2004/108/EC IEC 60950-1/VDE 0805 (SELV) EN 50178/VDE 0160 (PELV) DIN VDE 0100-410, DIN VDE 0106-1010 - UL/C-UL listed UL 508, UL/C-UL Recognized UL 60950, UL ANSI/ISA-12.12.01 Class I, Division 2, Groups A, B, C, D (Hazardous Location), NEC Class 2 as per UL 1310
Insulation voltage input/output	EN 61000-3-2
Electromagnetic compatibility	
Electrical safety	
Electronic equipm. for electrical power installations	
Safe isolation	
Budgetary standard	
UL approvals	
Limitation of harmonic line currents	

### Ordering data

Description	Type	Order No.	Pcs. / Pkt.
Power supply, primary-switched	STEP-PS/ 1AC/24DC/0.5	2868596	1



**Power supply,  
1 AC, 24 V DC, 0.75 A  
flat design, NEC Class 2**

UL US ENEC ClassNK CB  
Ex:



**Power supply,  
1 AC, 24 V DC, 0.75 A  
NEC Class 2**

UL US ENEC BSH ClassNK CB  
Ex:



**Power supply,  
48 V AC, 24 V DC, 0.5 A  
NEC Class 2**

UL US ENEC CB

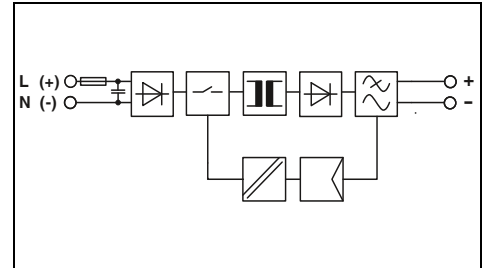
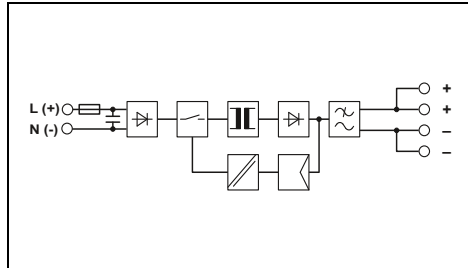
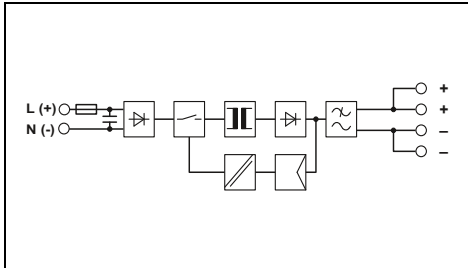

**Technical data**

100 V AC ... 240 V AC  
85 V AC ... 264 V AC / 95 V DC ... 250 V DC  
45 Hz ... 65 Hz / 0 Hz  
0.3 A (120 V AC) / 0.25 A (230 V AC)  
< 15 A / < 0.1 A<sup>2</sup>s  
> 15 ms (120 V AC) / > 70 ms (230 V AC)

24 V DC ±1 %  
0.75 A  
Yes / Yes  
< 0.5 W / < 3.6 W  
> 84% (for 230 V AC and nominal values)  
< 75 mV<sub>pp</sub>

**LED**

0.11 kg / 36 x 90 x 43 mm  
Alignable: 0 mm horizontally, 30 mm vertically  
Screw connection  
0.2 - 2.5 mm<sup>2</sup> / 0.2 - 2.5 mm<sup>2</sup> / 24 - 12  
IP20 / II  
> 926000 h (40°C)  
-25°C ... 70°C (> 55°C derating: 2.5%/K)

3.75 kV AC (routine test) / 4 kV AC (type test)

Conformance with EMC Directive 2004/108/EC  
IEC 60950-1/VDE 0805 (SELV)  
EN 50178/VDE 0160 (PELV)  
DIN VDE 0100-410, DIN VDE 0106-1010  
IEC 60335-1  
UL/C-UL listed UL 508, UL/C-UL Recognized UL 60950,  
NEC Class 2 as per UL 1310, UL ANSI/ISA-12.12.01 Class I,  
Division 2, Groups A, B, C, D (Hazardous Location)

EN 61000-3-2

**Ordering data**

Type	Order No.	Pcs. / Pkt.
STEP-PS/ 1AC/24DC/0.75/FL	2868622	1

**Technical data**

100 V AC ... 240 V AC  
85 V AC ... 264 V AC / 95 V DC ... 250 V DC  
45 Hz ... 65 Hz / 0 Hz  
0.3 A (120 V AC) / 0.2 A (230 V AC)  
< 15 A / < 0.1 A<sup>2</sup>s  
> 15 ms (120 V AC) / > 70 ms (230 V AC)

24 V DC ±1 %  
0.75 A  
Yes / Yes  
< 0.5 W / < 3.6 W  
> 84% (for 230 V AC and nominal values)  
< 75 mV<sub>pp</sub>

**LED**

0.11 kg / 36 x 90 x 61 mm  
Alignable: 0 mm horizontally, 30 mm vertically  
Screw connection  
0.2 - 2.5 mm<sup>2</sup> / 0.2 - 2.5 mm<sup>2</sup> / 24 - 12  
IP20 / II  
> 926000 h (40°C)  
-25°C ... 70°C (> 55°C derating: 2.5%/K)

3.75 kV AC (routine test) / 4 kV AC (type test)

Conformance with EMC Directive 2004/108/EC  
IEC 60950-1/VDE 0805 (SELV)  
EN 50178/VDE 0160 (PELV)  
DIN VDE 0100-410, DIN VDE 0106-1010  
IEC 60335-1  
UL/C-UL listed UL 508, UL/C-UL Recognized UL 60950,  
NEC Class 2 as per UL 1310, UL ANSI/ISA-12.12.01 Class I,  
Division 2, Groups A, B, C, D (Hazardous Location)

EN 61000-3-2

**Ordering data**

Type	Order No.	Pcs. / Pkt.
STEP-PS/ 1AC/24DC/0.75	2868635	1

**Technical data**

48 V AC  
43 V AC ... 52 V AC / 60 V DC ... 80 V DC  
45 Hz ... 65 Hz / 0 Hz  
0.5 A (43 V AC) / 0.45 A (48 V AC)  
< 10 A / < 0.1 A<sup>2</sup>s  
> 15 ms (48 V AC) / > 20 ms (52 V AC)

24 V DC ±1 %  
0.5 A  
Yes / Yes  
< 0.3 W / < 3.4 W  
> 81% (for 48 V AC and nominal values)  
< 30 mV<sub>pp</sub>

**LED**

0.07 kg / 18 x 90 x 61 mm  
Alignable: 0 mm horizontally, 30 mm vertically  
Screw connection  
0.2 - 2.5 mm<sup>2</sup> / 0.2 - 2.5 mm<sup>2</sup> / 24 - 12  
IP20 / II  
> 1860000 h (40°C)  
-25°C ... 70°C (> 55°C derating: 2.5%/K)

3.75 kV AC (routine test) / 4 kV AC (type test)

Conformance with EMC Directive 2004/108/EC  
IEC 60950-1/VDE 0805 (SELV)  
EN 50178/VDE 0160 (PELV)  
DIN VDE 0100-410  
-  
UL/C-UL listed UL 508, UL/C-UL Recognized UL 60950,  
NEC Class 2 as per UL 1310

EN 61000-3-2

**Ordering data**

Type	Order No.	Pcs. / Pkt.
STEP-PS/48AC/24DC/0.5	2868716	1

# Power supplies and UPS

## Power supply units

### STEP POWER - power supply units for distributor boards and flat control panels

#### STEP POWER, 1 AC, 24 V DC

- Flexible assembly by simply snapping the product onto the DIN rail or screwing it onto an even surface
- Energy savings thanks to maximum energy efficiency and incredibly low no-load losses
- Wide temperature range from -25°C to +70°C
- Reliable supply thanks to the high MTBF (mean time between failure)

#### STEP POWER, NEC Class 2

- Output power limited to 100 W: Specifically for applications that require certification according to UL 1310/508 Listed Class 2



**Power supply,  
1 AC, 24 V DC, 1.75 A  
NEC Class 2**

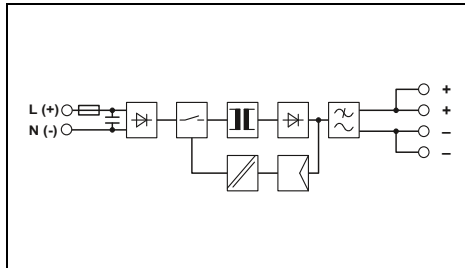

#### Technical data

<b>Input data</b>	
Nominal input voltage range	100 V AC ... 240 V AC
Input voltage range	85 V AC ... 264 V AC / 95 V DC ... 250 V DC
Frequency range	45 Hz ... 65 Hz / 0 Hz
Current consumption (nominal load)	0.6 A (120 V AC) / 0.3 A (230 V AC)
Inrush current limitation at 25°C (typ.) / I <sup>2</sup> t	< 15 A / < 0.6 A <sup>2</sup> s
Mains buffering (I <sub>N</sub> , typ.)	> 25 ms (120 V AC) / > 150 ms (230 V AC)
<b>Output data</b>	
Nominal output voltage	24 V DC ±1 %
Setting range of the output voltage	22.5 V DC ... 29.5 V DC (> 24 V constant capacity)
<b>Output current</b>	
Can be connected in parallel / series	1.75 A Yes / Yes
Max. power dissipation (no load / nominal load)	< 0.7 W / 5 W
Efficiency (typ.)	> 89% (for 230 V AC and nominal values)
Residual ripple	< 60 mV <sub>pp</sub>
<b>Signaling</b>	
Signaling DC OK	LED
<b>General data</b>	
Weight / Dimensions W x H x D	0.19 kg / 54 x 90 x 61 mm
Spacing when mounting	Alignable: 0 mm horizontally, 30 mm vertically
Connection method	Screw connection
Connection data solid / stranded / AWG	0.2 - 2.5 mm <sup>2</sup> / 0.2 - 2.5 mm <sup>2</sup> / 24 - 12
Degree of protection / Protection class	IP20 / II
MTBF (IEC 61709, SN 29500)	> 1569000 h (40°C)
Ambient temperature (operation)	-25°C ... 70°C (> 55°C derating: 2.5%/K)
<b>Standards/regulations</b>	
Insulation voltage input/output	3.75 kV AC (routine test) / 4 kV AC (type test)
<b>Electromagnetic compatibility</b>	
Electrical safety	Conformance with EMC Directive 2004/108/EC
Electronic equipm. for electrical power installations	IEC 60950-1/VDE 0805 (SELV)
Safe isolation	EN 50178/VDE 0160 (PELV)
UL approvals	DIN VDE 0100-410, DIN VDE 0106-1010 UL/C-UL listed UL 508, UL/C-UL Recognized UL 60950, NEC Class 2 as per UL 1310, UL ANSI/ISA-12.12.01 Class I, Division 2, Groups A, B, C, D (Hazardous Location)
<b>Limitation of harmonic line currents</b>	EN 61000-3-2

#### Ordering data

Description	Type	Order No.	Pcs. / Pkt.
<b>Power supply, primary-switched</b>	STEP-PS/ 1AC/24DC/1.75	2868648	1



**Power supply,  
1 AC, 24 V DC, 2.5 A  
NEC Class 2**

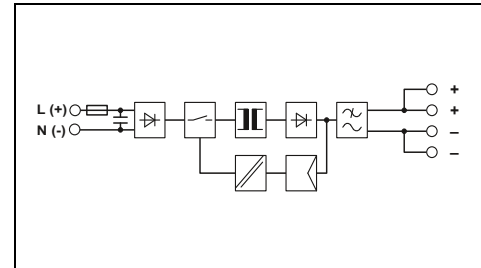

#### Technical data

<b>Input data</b>	
Nominal input voltage range	100 V AC ... 240 V AC
Input voltage range	85 V AC ... 264 V AC / 95 V DC ... 250 V DC
Frequency range	45 Hz ... 65 Hz / 0 Hz
Current consumption (nominal load)	0.8 A (120 V AC) / 0.4 A (230 V AC)
Inrush current limitation at 25°C (typ.) / I <sup>2</sup> t	< 15 A / < 0.6 A <sup>2</sup> s
Mains buffering (I <sub>N</sub> , typ.)	> 20 ms (120 V AC) / > 100 ms (230 V AC)
<b>Output data</b>	
Nominal output voltage	24 V DC ±1 %
Setting range of the output voltage	22.5 V DC ... 29.5 V DC (> 24 V constant capacity)
<b>Output current</b>	
Can be connected in parallel / series	2.5 A Yes / Yes
Max. power dissipation (no load / nominal load)	< 0.7 W / 9.9 W
Efficiency (typ.)	> 86% (for 230 V AC and nominal values)
Residual ripple	< 80 mV <sub>pp</sub>
<b>Signaling</b>	
Signaling DC OK	LED
<b>General data</b>	
Weight / Dimensions W x H x D	0.27 kg / 72 x 90 x 61 mm
Spacing when mounting	Alignable: 0 mm horizontally, 30 mm vertically
Connection method	Screw connection
Connection data solid / stranded / AWG	0.2 - 2.5 mm <sup>2</sup> / 0.2 - 2.5 mm <sup>2</sup> / 24 - 12
Degree of protection / Protection class	IP20 / II
MTBF (IEC 61709, SN 29500)	> 1061000 h (40°C)
Ambient temperature (operation)	-25°C ... 70°C (> 55°C derating: 2.5%/K)
<b>Standards/regulations</b>	
Insulation voltage input/output	3.75 kV AC (routine test) / 4 kV AC (type test)
<b>Electromagnetic compatibility</b>	
Electrical safety	Conformance with EMC Directive 2004/108/EC
Electronic equipm. for electrical power installations	IEC 60950-1/VDE 0805 (SELV)
Safe isolation	EN 50178/VDE 0160 (PELV)
UL approvals	DIN VDE 0100-410, DIN VDE 0106-1010 UL/C-UL listed UL 508, UL/C-UL Recognized UL 60950, NEC Class 2 as per UL 1310, UL ANSI/ISA-12.12.01 Class I, Division 2, Groups A, B, C, D (Hazardous Location)
<b>Limitation of harmonic line currents</b>	EN 61000-3-2

#### Ordering data

Description	Type	Order No.	Pcs. / Pkt.
<b>Power supply, primary-switched</b>	STEP-PS/ 1AC/24DC/2.5	2868651	1

new

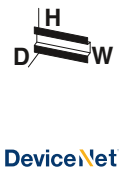

Power supply,  
1 AC, 24 V DC, 100 W  
NEC Class 2



Power supply,  
1 AC, 24 V DC, 4.2 A



Power supply,  
1 AC, 24 V DC, 3.5 A  
Input up to 277 V AC, NEC Class 2

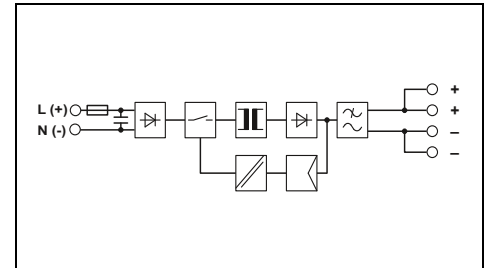
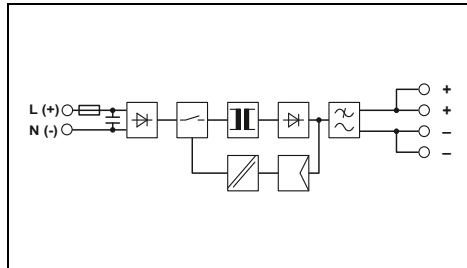
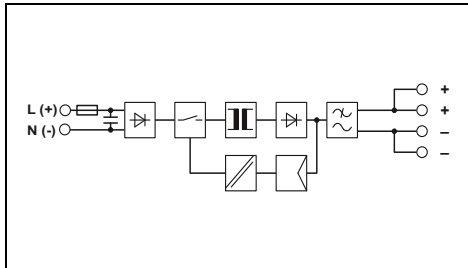

Technical data
100 V AC ... 240 V AC 85 V AC ... 264 V AC / 95 V DC ... 250 V DC 45 Hz ... 65 Hz 1.3 A (120 V AC) / 0.8 A (230 V AC) < 15 A / < 1 A <sup>2</sup> s > 25 ms (120 V AC) / > 120 ms (230 V AC)
24 V DC ±1 % 22.5 V DC ... 25 V DC (> 24 V constant capacity)
3.8 A No / No < 0.7 W / 11.8 W > 88% (for 230 V AC and nominal values) < 80 mV <sub>PP</sub>
LED
0.33 kg / 90 x 90 x 61 mm Alignable: 0 mm horizontally, 30 mm vertically Screw connection 0.2 - 2.5 mm <sup>2</sup> / 0.2 - 2.5 mm <sup>2</sup> / 24 - 12 IP20 / II > 897000 h (40°C) -25°C ... 70°C (> 55°C derating: 2.5%/K)
3.75 kV AC (routine test) / 4 kV AC (type test)
Conformance with EMC Directive 2004/108/EC IEC 60950-1/VDE 0805 (SELV) EN 50178/VDE 0160 (PELV) DIN VDE 0100-410, DIN VDE 0106-1010 UL/C-UL listed UL 508, UL/C-UL Recognized UL 60950, NEC Class 2 as per UL 1310, UL ANSI/ISA-12.12.01 Class I, Division 2, Groups A, B, C, D (Hazardous Location)
EN 61000-3-2

Technical data
100 V AC ... 240 V AC 85 V AC ... 264 V AC / 95 V DC ... 250 V DC 45 Hz ... 65 Hz / 0 Hz 1.3 A (120 V AC) / 0.8 A (230 V AC) < 15 A / < 1 A <sup>2</sup> s > 20 ms (120 V AC) / > 100 ms (230 V AC)
24 V DC ±1 % 22.5 V DC ... 29.5 V DC (> 24 V constant capacity)
4.2 A Yes / Yes < 0.7 W / 13.2 W > 88% (for 230 V AC and nominal values) < 40 mV <sub>PP</sub>
LED
0.33 kg / 90 x 90 x 61 mm Alignable: 0 mm horizontally, 30 mm vertically Screw connection 0.2 - 2.5 mm <sup>2</sup> / 0.2 - 2.5 mm <sup>2</sup> / 24 - 12 IP20 / II > 897000 h (40°C) -25°C ... 70°C (> 55°C derating: 2.5%/K)
3.75 kV AC (routine test) / 4 kV AC (type test)
Conformance with EMC Directive 2004/108/EC IEC 60950-1/VDE 0805 (SELV) EN 50178/VDE 0160 (PELV) DIN VDE 0100-410, DIN VDE 0106-1010 UL/C-UL listed UL 508, UL/C-UL Recognized UL 60950, UL ANSI/ISA-12.12.01 Class I, Division 2, Groups A, B, C, D (Hazardous Location)
EN 61000-3-2

Technical data
100 V AC ... 277 V AC 85 V AC ... 305 V AC / 95 V DC ... 250 V DC 45 Hz ... 65 Hz / 0 Hz 1.43 A (120 V AC) / 0.75 A (277 V AC) < 40 A / < 2.8 A <sup>2</sup> s > 25 ms (120 V AC) / > 160 ms (277 V AC)
24 V DC ±1 % 22.5 V DC ... 25 V DC (> 24 V constant capacity)
3.5 A Yes / Yes < 0.6 W / 11.5 W > 88% (for 277 V AC and nominal values) < 10 mV <sub>PP</sub>
LED
0.3 kg / 90 x 90 x 61 mm Alignable: 0 mm horizontally, 30 mm vertically Screw connection 0.2 - 2.5 mm <sup>2</sup> / 0.2 - 2.5 mm <sup>2</sup> / 24 - 12 IP20 / II > 1094000 h (40°C) -25°C ... 70°C (> 55°C derating: 2.5%/K)
3.75 kV AC (routine test) / 4 kV AC (type test)
Conformance with EMC Directive 2004/108/EC IEC 60950-1/VDE 0805 (SELV) EN 50178/VDE 0160 (PELV) DIN VDE 0100-410, DIN VDE 0106-1010 UL/C-UL listed UL 508, UL/C-UL Recognized UL 60950, NEC Class 2 as per UL 1310
EN 61000-3-2

Ordering data		
Type	Order No.	Pcs. / Pkt.
STEP-PS/ 1AC/24DC/3.8/2LPS	2868677	1

Ordering data		
Type	Order No.	Pcs. / Pkt.
STEP-PS/ 1AC/24DC/4.2	2868664	1

Ordering data		
Type	Order No.	Pcs. / Pkt.
STEP-PS/277AC/24DC/3.5	2904945	1

# Power supplies and UPS

## Power supply units

### STEP POWER - power supply units for distributor boards and flat control panels

#### STEP POWER, 1 AC, 5 to 48 V DC

- Flexible assembly by simply snapping the product onto the DIN rail or screwing it onto an even surface
- Energy savings thanks to maximum energy efficiency and incredibly low no-load losses
- Wide temperature range from -25°C to +70°C
- Reliable supply thanks to the high MTBF (mean time between failure)

#### STEP POWER, 5 V DC, 2 A

- Slim design with an overall width of just 18 mm (1 pitch)

#### STEP POWER, 5 V DC, 6.5 A

- Adjustable output voltage of 4 to 6.5 V DC

#### STEP POWER, 15 V DC, 4 A

- Adjustable output voltage of 10 to 16.5 V DC

#### STEP POWER, 48 V DC, 2 A

- Adjustable output voltage of 30 to 56 V DC



**Power supply,  
1 AC, 5 V DC, 2 A  
NEC Class 2**

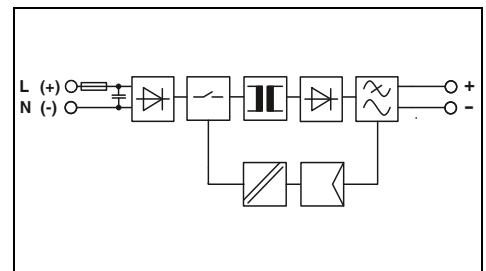

### Technical data

<b>Input data</b>	
Nominal input voltage range	100 V AC ... 240 V AC
Input voltage range	85 V AC ... 264 V AC / 95 V DC ... 250 V DC
Frequency range	45 Hz ... 65 Hz / 0 Hz
Current consumption (nominal load)	0.2 A (120 V AC) / 0.13 A (230 V AC)
Inrush current limitation at 25°C (typ.) / I <sup>2</sup> t	< 15 A / < 0.1 A <sup>2</sup> s
Mains buffering (I <sub>N</sub> , typ.)	> 25 ms (120 V AC) / > 110 ms (230 V AC)
<b>Output data</b>	
Nominal output voltage	5 V DC ±1 %
Setting range of the output voltage	-
<b>Output current</b>	
Can be connected in parallel / series	2 A Yes / Yes
Max. power dissipation (no load / nominal load)	< 0.4 W / < 2.6 W
Efficiency (typ.)	> 81% (for 230 V AC and nominal values)
Residual ripple	< 50 mV <sub>pp</sub>
<b>Signaling</b>	
Signaling DC OK	LED
<b>General data</b>	
Weight / Dimensions W x H x D	0.1 kg / 18 x 90 x 61 mm
Spacing when mounting	Alignable: 0 mm horizontally, 30 mm vertically
Connection method	Screw connection
Connection data solid / stranded / AWG	0.2 - 2.5 mm <sup>2</sup> / 0.2 - 2.5 mm <sup>2</sup> / 24 - 12
Degree of protection / Protection class	IP20 / II
MTBF (IEC 61709, SN 29500)	> 1812000 h (40°C)
Ambient temperature (operation)	-25°C ... 70°C (> 55°C derating: 2.5%/K)
<b>Standards/regulations</b>	
Insulation voltage input/output	3.75 kV AC (routine test) / 4 kV AC (type test)
<b>Electromagnetic compatibility</b>	
Electrical safety	Conformance with EMC Directive 2004/108/EC
Electronic equipm. for electrical power installations	IEC 60950-1/VDE 0805 (SELV)
Safe isolation	EN 50178/VDE 0160 (PELV)
UL approvals	DIN VDE 0100-410, DIN VDE 0106-1010 UL/C-UL listed UL 508, UL/C-UL Recognized UL 60950, NEC Class 2 as per UL 1310
<b>Limitation of harmonic line currents</b>	EN 61000-3-2

### Ordering data

Description	Type	Order No.	Pcs. / Pkt.
<b>Power supply, primary-switched, 1-phase</b>	<b>STEP-PS/ 1AC/ 5DC/2</b>	<b>2320513</b>	1



Power supply,  
1 AC, 5 V DC, 6.5 A

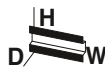

Power supply,  
1 AC, 15 V DC, 4 A



Power supply,  
1 AC, 48 V DC, 2 A

UL US ENEC ClassNK CB  
Ex:

UL US ENEC ClassNK CB  
Ex:

UL US ENEC ClassNK CB  
Ex:

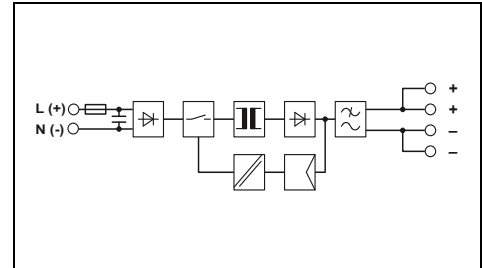
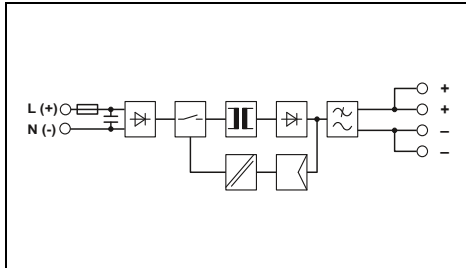
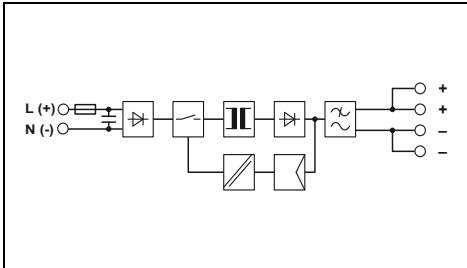

Technical data

100 V AC ... 240 V AC  
85 V AC ... 264 V AC / 95 V DC ... 250 V DC  
45 Hz ... 65 Hz / 0 Hz  
0.5 A (120 V AC) / 0.3 A (230 V AC)  
< 15 A / < 0.6 A<sup>2</sup>s  
> 25 ms (120 V AC) / > 140 ms (230 V AC)

5 V DC ±1 %  
4 V DC ... 6.5 V DC (> 5 V constant capacity)

6.5 A  
Yes / Yes  
< 0.4 W / 8.1 W  
> 80% (for 230 V AC and nominal values)  
< 50 mV<sub>pp</sub>

LED

0.27 kg / 72 x 90 x 61 mm  
Alignable: 0 mm horizontally, 30 mm vertically  
Screw connection  
0.2 - 2.5 mm<sup>2</sup> / 0.2 - 2.5 mm<sup>2</sup> / 24 - 12  
IP20 / II  
> 1111000 h (40°C)  
-25°C ... 70°C (> 55°C derating: 2.5%/K)

3.75 kV AC (routine test) / 4 kV AC (type test)

Conformance with EMC Directive 2004/108/EC  
IEC 60950-1/VDE 0805 (SELV)  
EN 50178/VDE 0160 (PELV)  
DIN VDE 0100-410, DIN VDE 0106-1010  
UL/C-UL listed UL 508, UL/C-UL Recognized UL 60950,  
UL ANSI/ISA-12.12.01 Class I, Division 2, Groups A, B, C, D  
(Hazardous Location)  
EN 61000-3-2

Ordering data

Type	Order No.	Pcs. / Pkt.
STEP-PS/ 1AC/ 5DC/6.5	2868541	1

Technical data

100 V AC ... 240 V AC  
85 V AC ... 264 V AC / 95 V DC ... 250 V DC  
45 Hz ... 65 Hz / 0 Hz  
0.8 A (120 V AC) / 0.5 A (230 V AC)  
< 15 A / < 0.6 A<sup>2</sup>s  
> 27 ms (120 V AC) / > 120 ms (230 V AC)

15 V DC ±1 %  
10 V DC ... 16.5 V DC (> 15 V constant capacity)

4 A  
Yes / Yes  
< 0.5 W / 8.6 W  
> 87% (for 230 V AC and nominal values)  
< 55 mV<sub>pp</sub>

LED

0.27 kg / 72 x 90 x 61 mm  
Alignable: 0 mm horizontally, 30 mm vertically  
Screw connection  
0.2 - 2.5 mm<sup>2</sup> / 0.2 - 2.5 mm<sup>2</sup> / 24 - 12  
IP20 / II  
> 1134000 h (40°C)  
-25°C ... 70°C (> 55°C derating: 2.5%/K)

3.75 kV AC (routine test) / 4 kV AC (type test)

Conformance with EMC Directive 2004/108/EC  
IEC 60950-1/VDE 0805 (SELV)  
EN 50178/VDE 0160 (PELV)  
DIN VDE 0100-410, DIN VDE 0106-1010  
UL/C-UL listed UL 508, UL/C-UL Recognized UL 60950,  
UL ANSI/ISA-12.12.01 Class I, Division 2, Groups A, B, C, D  
(Hazardous Location)  
EN 61000-3-2

Ordering data

Type	Order No.	Pcs. / Pkt.
STEP-PS/ 1AC/15DC/4	2868619	1

Technical data

100 V AC ... 240 V AC  
85 V AC ... 264 V AC / 95 V DC ... 250 V DC  
45 Hz ... 65 Hz / 0 Hz  
1.3 A (120 V AC) / 0.8 A (230 V AC)  
< 15 A / < 1.4 A<sup>2</sup>s  
> 20 ms (120 V AC) / > 120 ms (230 V AC)

48 V DC ±1 %  
30 V DC ... 56 V DC (> 48 V constant capacity)

2 A  
Yes / Yes  
< 0.9 W / 9.6 W  
> 90% (for 230 V AC and nominal values)  
< 30 mV<sub>pp</sub>

LED

0.33 kg / 90 x 90 x 61 mm  
Alignable: 0 mm horizontally, 30 mm vertically  
Screw connection  
0.2 - 2.5 mm<sup>2</sup> / 0.2 - 2.5 mm<sup>2</sup> / 24 - 12  
IP20 / II  
> 1048000 h (40°C)  
-25°C ... 70°C (> 55°C derating: 2.5%/K)

3.75 kV AC (routine test) / 4 kV AC (type test)

Conformance with EMC Directive 2004/108/EC  
IEC 60950-1/VDE 0805 (SELV)  
EN 50178/VDE 0160 (PELV)  
DIN VDE 0100-410, DIN VDE 0106-1010  
UL/C-UL listed UL 508, UL/C-UL Recognized UL 60950,  
UL ANSI/ISA-12.12.01 Class I, Division 2, Groups A, B, C, D  
(Hazardous Location)  
EN 61000-3-2

Ordering data

Type	Order No.	Pcs. / Pkt.
STEP-PS/ 1AC/48DC/2	2868680	1

# Power supplies and UPS

## Power supply units

### STEP POWER - power supply units for distributor boards and flat control panels

#### STEP POWER, 1 AC, 12 V DC

- Flexible assembly by simply snapping the product onto the DIN rail or screwing it onto an even surface
- Energy savings thanks to maximum energy efficiency and incredibly low no-load losses
- Wide temperature range from -25°C to +70°C
- Reliable supply thanks to the high MTBF (mean time between failure)



**Power supply,  
1 AC, 12 V DC, 1 A  
NEC Class 2**

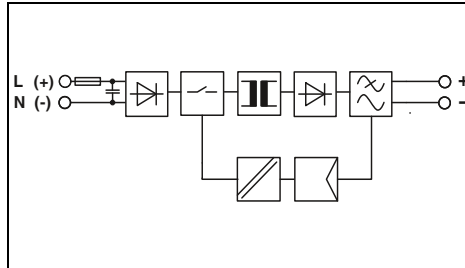

#### Technical data

<b>Input data</b>	
Nominal input voltage range	100 V AC ... 240 V AC
Input voltage range	85 V AC ... 264 V AC / 95 V DC ... 250 V DC
Frequency range	45 Hz ... 65 Hz / 0 Hz
Current consumption (nominal load)	0.26 A (120 V AC) / 0.13 A (230 V AC)
Inrush current limitation at 25°C (typ.) / I <sup>2</sup> t	< 15 A / < 0.1 A <sup>2</sup> s
Mains buffering (I <sub>N</sub> , typ.)	> 15 ms (120 V AC) / > 90 ms (230 V AC)
<b>Output data</b>	
Nominal output voltage	12 V DC ±1 %
Setting range of the output voltage	-
<b>Output current</b>	
Can be connected in parallel / series	1 A Yes / Yes
Max. power dissipation (no load / nominal load)	< 0.4 W / < 2.8 W
Efficiency (typ.)	> 83% (for 230 V AC and nominal values)
Residual ripple	< 20 mV <sub>pp</sub>
<b>Signaling</b>	
Signaling DC OK	LED
<b>General data</b>	
Weight / Dimensions W x H x D	0.07 kg / 18 x 90 x 61 mm
Spacing when mounting	Alignable: 0 mm horizontally, 30 mm vertically
Connection method	Screw connection
Connection data solid / stranded / AWG	0.2 - 2.5 mm <sup>2</sup> / 0.2 - 2.5 mm <sup>2</sup> / 24 - 12
Degree of protection / Protection class	IP20 / II
MTBF (IEC 61709, SN 29500)	> 1478000 h (40°C)
Ambient temperature (operation)	-25°C ... 70°C (> 55°C derating: 2.5%/K)
<b>Standards/regulations</b>	
Insulation voltage input/output	3.75 kV AC (routine test) / 4 kV AC (type test)
<b>Electromagnetic compatibility</b>	
Electrical safety	Conformance with EMC Directive 2004/108/EC
Electronic equipm. for electrical power installations	IEC 60950-1/VDE 0805 (SELV)
Safe isolation	EN 50178/VDE 0160 (PELV)
Budgetary standard	DIN VDE 0100-410, DIN VDE 0106-1010
UL approvals	- UL/C-UL listed UL 508, UL/C-UL Recognized UL 60950, NEC Class 2 as per UL 1310, UL ANSI/ISA-12.12.01 Class I, Division 2, Groups A, B, C, D (Hazardous Location)
<b>Limitation of harmonic line currents</b>	
	EN 61000-3-2

#### Ordering data

Description	Type	Order No.	Pcs. / Pkt.
Power supply, primary-switched	STEP-PS/ 1AC/12DC/1	2868538	1



**Power supply,  
1 AC, 12 V DC, 1.5 A  
Flat design, NEC Class 2**

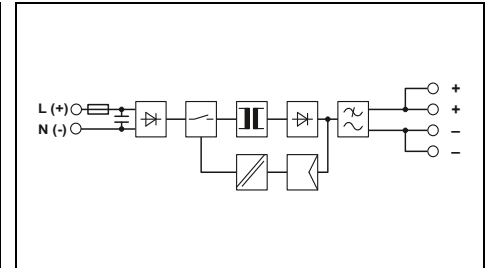

#### Technical data

<b>Input data</b>	
Nominal input voltage range	100 V AC ... 240 V AC
Input voltage range	85 V AC ... 264 V AC / 95 V DC ... 250 V DC
Frequency range	45 Hz ... 65 Hz / 0 Hz
Current consumption (nominal load)	0.33 A (120 V AC) / 0.18 A (230 V AC)
Inrush current limitation at 25°C (typ.) / I <sup>2</sup> t	< 15 A / < 0.1 A <sup>2</sup> s
Mains buffering (I <sub>N</sub> , typ.)	> 15 ms (120 V AC) / > 70 ms (230 V AC)
<b>Output data</b>	
Nominal output voltage	12 V DC ±1 %
Setting range of the output voltage	-
<b>Output current</b>	
Can be connected in parallel / series	1.5 A Yes / Yes
Max. power dissipation (no load / nominal load)	< 0.4 W / < 3.2 W
Efficiency (typ.)	> 84% (for 230 V AC and nominal values)
Residual ripple	< 75 mV <sub>pp</sub>
<b>Signaling</b>	
Signaling DC OK	LED
<b>General data</b>	
Weight / Dimensions W x H x D	0.07 kg / 36 x 90 x 43 mm
Spacing when mounting	Alignable: 0 mm horizontally, 30 mm vertically
Connection method	Screw connection
Connection data solid / stranded / AWG	0.2 - 2.5 mm <sup>2</sup> / 0.2 - 2.5 mm <sup>2</sup> / 24 - 12
Degree of protection / Protection class	IP20 / II
MTBF (IEC 61709, SN 29500)	> 1800000 h (40°C)
Ambient temperature (operation)	-25°C ... 70°C (> 55°C derating: 2.5%/K)
<b>Standards/regulations</b>	
Insulation voltage input/output	3.75 kV AC (routine test) / 4 kV AC (type test)
<b>Electromagnetic compatibility</b>	
Electrical safety	Conformance with EMC Directive 2004/108/EC
Electronic equipm. for electrical power installations	IEC 60950-1/VDE 0805 (SELV)
Safe isolation	EN 50178/VDE 0160 (PELV)
Budgetary standard	DIN VDE 0100-410, DIN VDE 0106-1010
UL approvals	IEC 60335-1 UL/C-UL listed UL 508, UL/C-UL Recognized UL 60950, NEC Class 2 as per UL 1310, UL ANSI/ISA-12.12.01 Class I, Division 2, Groups A, B, C, D (Hazardous Location)
<b>Limitation of harmonic line currents</b>	
	EN 61000-3-2

#### Ordering data

Description	Type	Order No.	Pcs. / Pkt.
Power supply, primary-switched	STEP-PS/ 1AC/12DC/1.5/FL	2868554	1





Power supply,  
1 AC, 12 V DC, 1.5 A  
NEC Class 2

UL US ENEC ERIE ClassNK CB  
Ex: IMA



Power supply,  
1 AC, 12 V DC, 3 A  
NEC Class 2

UL US ENEC ERIE ClassNK CB  
Ex: IMA



Power supply,  
1 AC, 12 V DC, 5 A

UL US ENEC ERIE ClassNK CB  
Ex: IMA

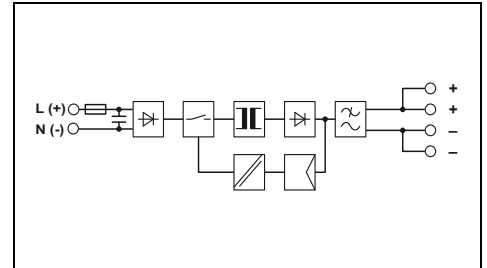
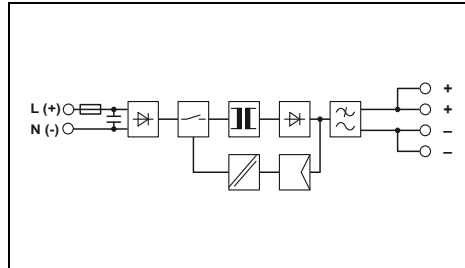
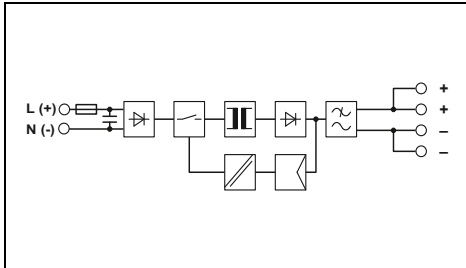

Technical data

100 V AC ... 240 V AC  
85 V AC ... 264 V AC / 95 V DC ... 250 V DC  
45 Hz ... 65 Hz / 0 Hz  
0.3 A (120 V AC) / 0.2 A (230 V AC)  
< 15 A / < 0.1 A<sup>2</sup>s  
> 15 ms (120 V AC) / > 70 ms (230 V AC)

12 V DC ±1 %  
-

1.5 A  
Yes / Yes  
< 0.4 W / < 3.2 W  
> 84% (for 230 V AC and nominal values)  
< 75 mV<sub>PP</sub>

LED

0.11 kg / 36 x 90 x 61 mm  
Alignable: 0 mm horizontally, 30 mm vertically  
Screw connection  
0.2 - 2.5 mm<sup>2</sup> / 0.2 - 2.5 mm<sup>2</sup> / 24 - 12  
IP20 / II  
> 1800000 h (40°C)  
-25°C ... 70°C (> 55°C derating: 2.5%/K)

3.75 kV AC (routine test) / 4 kV AC (type test)

Conformance with EMC Directive 2004/108/EC  
IEC 60950-1/VDE 0805 (SELV)  
EN 50178/VDE 0160 (PELV)  
DIN VDE 0100-410, DIN VDE 0106-1010  
IEC 60335-1  
UL/C-UL listed UL 508, UL/C-UL Recognized UL 60950,  
NEC Class 2 as per UL 1310, UL ANSI/ISA-12.12.01 Class I,  
Division 2, Groups A, B, C, D (Hazardous Location)

EN 61000-3-2

Technical data

100 V AC ... 240 V AC  
85 V AC ... 264 V AC / 95 V DC ... 250 V DC  
45 Hz ... 65 Hz / 0 Hz  
0.6 A (120 V AC) / 0.3 A (230 V AC)  
< 15 A / < 0.6 A<sup>2</sup>s  
> 26 ms (120 V AC) / > 160 ms (230 V AC)

12 V DC ±1 %  
10 V DC ... 16.5 V DC (> 12 V constant capacity)

3 A  
Yes / Yes  
< 0.5 W / 6.4 W  
> 85% (for 230 V AC and nominal values)  
< 40 mV<sub>PP</sub>

LED

0.19 kg / 54 x 90 x 61 mm  
Alignable: 0 mm horizontally, 30 mm vertically  
Screw connection  
0.2 - 2.5 mm<sup>2</sup> / 0.2 - 2.5 mm<sup>2</sup> / 24 - 12  
IP20 / II  
> 1689000 h (40°C)  
-25°C ... 70°C (> 55°C derating: 2.5%/K)

3.75 kV AC (routine test) / 4 kV AC (type test)

Conformance with EMC Directive 2004/108/EC  
IEC 60950-1/VDE 0805 (SELV)  
EN 50178/VDE 0160 (PELV)  
DIN VDE 0100-410, DIN VDE 0106-1010  
-  
UL/C-UL listed UL 508, UL/C-UL Recognized UL 60950,  
NEC Class 2 as per UL 1310, UL ANSI/ISA-12.12.01 Class I,  
Division 2, Groups A, B, C, D (Hazardous Location)

EN 61000-3-2

Technical data

100 V AC ... 240 V AC  
85 V AC ... 264 V AC / 95 V DC ... 250 V DC  
45 Hz ... 65 Hz / 0 Hz  
0.8 A (120 V AC) / 0.5 A (230 V AC)  
< 15 A / < 0.6 A<sup>2</sup>s  
> 27 ms (120 V AC) / > 120 ms (230 V AC)

12 V DC ±1 %  
10 V DC ... 16.5 V DC (> 12 V constant capacity)

5 A  
Yes / Yes  
< 0.5 W / 8.6 W  
> 87% (for 230 V AC and nominal values)  
< 55 mV<sub>PP</sub>

LED

0.27 kg / 72 x 90 x 61 mm  
Alignable: 0 mm horizontally, 30 mm vertically  
Screw connection  
0.2 - 2.5 mm<sup>2</sup> / 0.2 - 2.5 mm<sup>2</sup> / 24 - 12  
IP20 / II  
> 1134000 h (40°C)  
-25°C ... 70°C (> 55°C derating: 2.5%/K)

3.75 kV AC (routine test) / 4 kV AC (type test)

Conformance with EMC Directive 2004/108/EC  
IEC 60950-1/VDE 0805 (SELV)  
EN 50178/VDE 0160 (PELV)  
DIN VDE 0100-410, DIN VDE 0106-1010  
-  
UL/C-UL listed UL 508, UL/C-UL Recognized UL 60950,  
UL ANSI/ISA-12.12.01 Class I, Division 2, Groups A, B, C, D  
(Hazardous Location)

EN 61000-3-2

Ordering data

Type	Order No.	Pcs. / Pkt.
STEP-PS/ 1AC/12DC/1.5	2868567	1

Ordering data

Type	Order No.	Pcs. / Pkt.
STEP-PS/ 1AC/12DC/3	2868570	1

Ordering data

Type	Order No.	Pcs. / Pkt.
STEP-PS/ 1AC/12DC/5	2868583	1



**QUINT and MINI DC/DC converters alter the voltage level, regenerate the voltage at the end of long cables, or enable the creation of independent supply systems by means of electrical isolation.**

There are numerous fields of application for DC/DC converters. As the name suggests, they convert voltages in order to match different voltage levels to one another. On long supply lines, they raise the voltage to compensate for voltage drops.

DC/DC converters separate circuits from each other by means of electrical isolation and protect the sensitive loads by decoupling them. The primary-switched switching devices have an internal intermediate circuit. This acts as a filter. This means, for example, that grounded and non-grounded circuits can be kept separate. Another advantage is the protection of critical loads from disruptive voltage fluctuations: if, for example, a motor is switched on that requires a high current for the starting torque, there is a brief voltage dip and sensitive loads shut down. The same occurs when loads with high input capacities are switched on. Troubleshooting these temporary faults is often difficult and time-consuming.

DC/DC converters are also ideal in battery-supported power supply networks or solutions with unregulated transformers, when sensitive loads require a stable DC.

### QUINT POWER – maximum functionality

Cost-effective selective fuse protection with SFB technology:

In order to trip standard circuit breakers magnetically and quickly, power supply units must be able to supply several times the nominal current for a short period. With SFB (selective fuse breaking) technology, which supplies up to 6 times the nominal current for 12 ms, a dynamic power reserve is available. Faulty current paths are selectively switched off, the fault is isolated, and important system components remain operational.

Preventive function monitoring:

Comprehensive diagnostics are provided through constant monitoring of the input voltage, output voltage, and output current. This preventive monitoring visualizes critical operating states, before errors can occur. Remote monitoring is provided by means of active switching outputs and floating relay contacts.

Power reserve POWER BOOST:

The static power reserve offers up to 1.25 times the nominal current permanently. At ambient temperatures of up to +40°C the POWER BOOST is continuously available and at higher temperatures, it is available for a few minutes. This ensures that both high inrush currents of capacitive loads, as well as loads with DC/DC converters in the primary circuit, can be reliably supplied.

**i** Your web code: #0152



**QUINT POWER**

The unique SFB technology and preventive function monitoring maximize the availability of your application.

- Quick tripping of standard circuit breakers with SFB technology
- Preventive function monitoring
- Reliable starting of difficult loads with POWER BOOST

**QUINT POWER CO with protective coating for extreme requirements**

The protective coating on these DC/DC converters protects against dust, corrosive gases, and 100% humidity as well as failure caused by corrosion-related creepage currents and electrochemical migration.

- OVP (Over Voltage Protection) limits surge voltages to 32 V
- Wide temperature range from -40°C to +70°C

**MINI DC/DC converters - for control technology**

MINI DC/DC converters come into their own in fields where modular electronics housing has become the standard.

- Service-friendly connection technology with coded COMBICON connectors
- Active function monitoring with switching output for remote monitoring of the output voltage

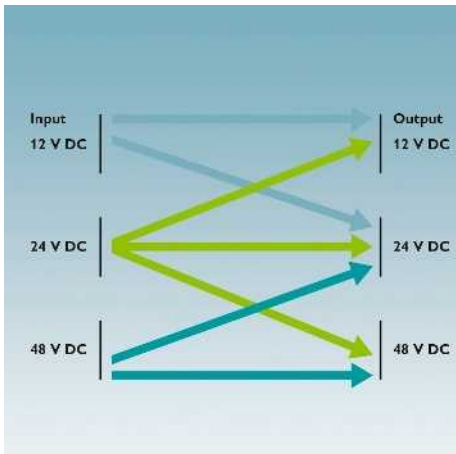

**Voltage levels of QUINT DC/DC converters with 12 to 48 V DC**

The QUINT DC/DC converters alter the voltage level:

- Input voltages:
  - 12 V DC (9 ... 18 V DC),
  - 24 V DC (18 ... 32 V DC),
  - 48 V DC (30 ... 60 V DC)
- Output voltages:
  - 12 V DC (5 ... 18 V DC),
  - 24 V DC (18 ... 29.5 V DC),
  - 48 V DC (30 ... 56 V DC)

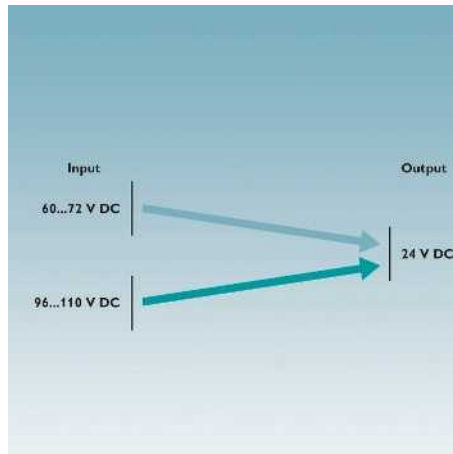

**Voltage levels of QUINT DC/DC converters with 60 to 110 V DC**

The QUINT DC/DC converters alter the voltage level:

- Input voltages:
  - 60 to 72 V DC (42 ... 96 V DC),
  - 96 to 110 V DC (67 ... 154 V DC)
- Output voltages:
  - 24 V DC (18 ... 29.5 V DC)

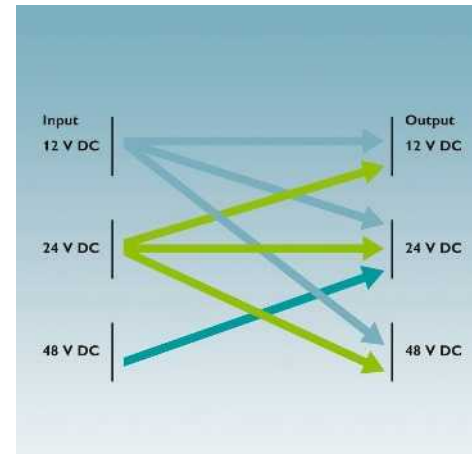

**Voltage levels of MINI DC/DC converters**

The MINI DC/DC converters alter the voltage level:

- Input voltages:
  - 12 V DC (10 ... 32 V DC),
  - 24 V DC (10 ... 32 V DC),
  - 48 V DC (36 ... 75 V DC)
- Output voltages:
  - 5 ... 15 V DC (5 ... 15 V DC),
  - 24 V DC (22.5 ... 28.5 V DC),
  - 48 V DC (30 ... 56 V DC)

# Power supplies and UPS

## DC/DC converters

### QUINT DC/DC converters

#### QUINT POWER, 24 V DC input

- Support conversion to various voltage levels
- Constant voltage: output voltage regenerated even at the end of long cables
- Electrical isolation: for setting up independent supply systems
- SFB technology: fast tripping of standard circuit breakers, thanks to the dynamic power reserve with up to 6 times the nominal current for 12 ms
- Reliable starting of difficult loads thanks to the static POWER BOOST power reserve with up to 125% of the nominal current permanently
- Preventive function monitoring warns against critical operating states before errors occur

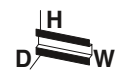

DC/DC converter,  
24 V DC / 24 V DC, 5 A

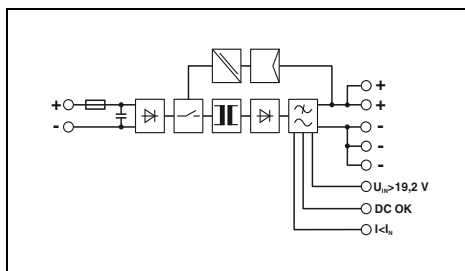

#### Technical data

Input data	
Nominal input voltage range	24 V DC
Input voltage range	18 V DC ... 32 V DC
Current consumption (POWER BOOST)	7 A (24 V, I <sub>BOOST</sub> )
Inrush current limitation at 25°C (typ.) / I <sup>2</sup> t	< 15 A / < 0.5 A <sup>2</sup> s
Mains buffering (I <sub>N</sub> , typ.)	> 10 ms (24 V DC)
Output data	
Nominal output voltage	24 V DC ±1 %
Setting range of the output voltage	18 V DC ... 29.5 V DC (> 24 V constant capacity)
Output current / POWER BOOST / SFB (12 ms)	
Magnetic fuse tripping	5 A / 6.25 A / 30 A
Can be connected in parallel / series	B2 / B4 / C2
Max. power dissipation (no load / nominal load)	Yes / Yes
Efficiency (typ.)	2.4 W / 11.4 W
Residual ripple	> 92%
Signaling	
Signaling DC OK	< 20 mV <sub>pp</sub>
Boost signaling	LED, active switching output
U <sub>IN</sub> signaling	LED, active switching output
General data	
Weight / Dimensions W x H x D	0.7 kg / 32 x 130 x 125 mm
Spacing when mounting	Alignable: 5 mm horizontally, 15 mm next to active components, 50 mm vertically
Connection method	
Input connection data (solid / stranded / AWG)	Plug-in screw connection
Output connection data (solid / stranded / AWG)	0.2 - 2.5 mm <sup>2</sup> / 0.2 - 2.5 mm <sup>2</sup> / 24 - 12
Signal connection data (solid / stranded / AWG)	0.2 - 2.5 mm <sup>2</sup> / 0.2 - 2.5 mm <sup>2</sup> / 24 - 12
Degree of protection / Protection class	0.2 - 2.5 mm <sup>2</sup> / 0.2 - 2.5 mm <sup>2</sup> / 24 - 12
MTBF (IEC 61709, SN 29500)	IP20 / III
Ambient temperature (operation)	> 890000 h (40°C)
Max. permissible relative humidity (operation)	-25°C ... 70°C (> 60°C derating: 2.5%/K, startup at -40°C type-tested)
Standards/regulations	≤ 95% (at 25°C, non-condensing)
Insulation voltage input/output	1 kV (routine test) / 1.5 kV (type test)
Electromagnetic compatibility	Conformance with EMC Directive 2004/108/EC
Electrical safety	EN 60950-1/VDE 0805 (SELV)
Electronic equipm. for electrical power installations	EN 50178/VDE 0160 (PELV)
Safe isolation	DIN VDE 0100-410
UL approvals	UL/C-UL listed UL 508, UL/C-UL Recognized UL 60950, UL ANSI/ISA-12.12.01 Class I, Division 2, Groups A, B, C, D (Hazardous Location)



DC/DC converter,  
24 V DC / 24 V DC, 10 A

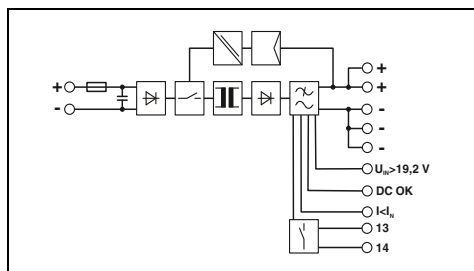

#### Technical data

Input data	
Nominal input voltage range	24 V DC
Input voltage range	18 V DC ... 32 V DC
Current consumption (POWER BOOST)	14 A (24 V, I <sub>BOOST</sub> )
Inrush current limitation at 25°C (typ.) / I <sup>2</sup> t	< 15 A / < 2.7 A <sup>2</sup> s
Mains buffering (I <sub>N</sub> , typ.)	> 10 ms (24 V DC)
Output data	
Nominal output voltage	24 V DC ±1 %
Setting range of the output voltage	18 V DC ... 29.5 V DC (> 24 V constant capacity)
Output current / POWER BOOST / SFB (12 ms)	
Magnetic fuse tripping	10 A / 12.5 A / 60 A
Can be connected in parallel / series	B2 / B4 / B6 / C2 / C4
Max. power dissipation (no load / nominal load)	Yes / Yes
Efficiency (typ.)	1.6 W / 24 W
Residual ripple	> 92%
Signaling	
Signaling DC OK	< 20 mV <sub>pp</sub>
Boost signaling	LED, active switching output, relay contact
U <sub>IN</sub> signaling	LED, active switching output
General data	
Weight / Dimensions W x H x D	0.9 kg / 48 x 130 x 125 mm
Spacing when mounting	Alignable: 5 mm horizontally, 15 mm next to active components, 50 mm vertically
Connection method	
Input connection data (solid / stranded / AWG)	Plug-in screw connection
Output connection data (solid / stranded / AWG)	0.2 - 2.5 mm <sup>2</sup> / 0.2 - 2.5 mm <sup>2</sup> / 24 - 12
Signal connection data (solid / stranded / AWG)	0.2 - 2.5 mm <sup>2</sup> / 0.2 - 2.5 mm <sup>2</sup> / 24 - 12
Degree of protection / Protection class	0.2 - 2.5 mm <sup>2</sup> / 0.2 - 2.5 mm <sup>2</sup> / 24 - 12
MTBF (IEC 61709, SN 29500)	IP20 / III
Ambient temperature (operation)	> 763000 h (40°C)
Max. permissible relative humidity (operation)	-25°C ... 70°C (> 60°C derating: 2.5%/K, startup at -40°C type-tested)
Standards/regulations	≤ 95% (at 25°C, non-condensing)
Insulation voltage input/output	1 kV (routine test) / 1.5 kV (type test)
Electromagnetic compatibility	Conformance with EMC Directive 2004/108/EC
Electrical safety	EN 60950-1/VDE 0805 (SELV)
Electronic equipm. for electrical power installations	EN 50178/VDE 0160 (PELV)
Safe isolation	DIN VDE 0100-410
UL approvals	UL/C-UL listed UL 508, UL/C-UL Recognized UL 60950, UL ANSI/ISA-12.12.01 Class I, Division 2, Groups A, B, C, D (Hazardous Location)

#### Ordering data

Description	Type	Order No.	Pcs. / Pkt.
DC/DC converter, primary-switched	QUINT-PS/24DC/24DC/5	2320034	1

#### Ordering data

Description	Type	Order No.	Pcs. / Pkt.
DC/DC converter, primary-switched	QUINT-PS/24DC/24DC/10	2320092	1



DC/DC converter,  
24 V DC / 24 V DC, 20 A



DC/DC converter,  
24 V DC / 12 V DC, 8 A

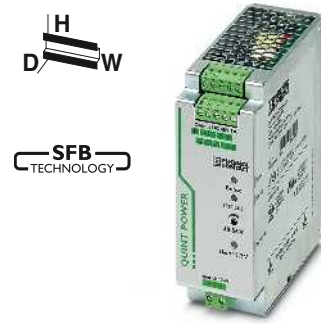

DC/DC converter,  
24 V DC / 48 V DC, 5 A

UL ENEC ERIE ClassNK CB  
Ex:

UL ENEC ERIE ABS ClassNK CB  
Ex:

UL ENEC ERIE ABS ClassNK CB  
Ex:

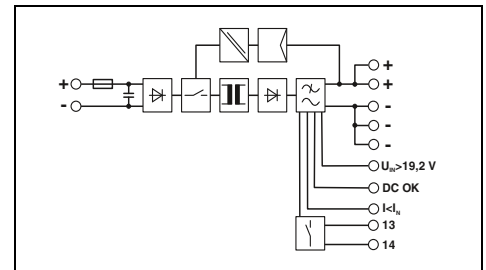
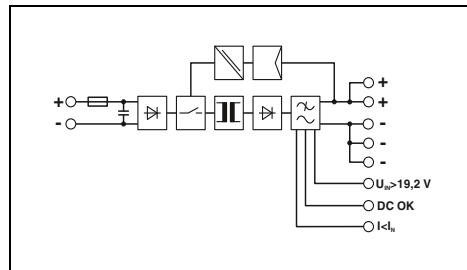
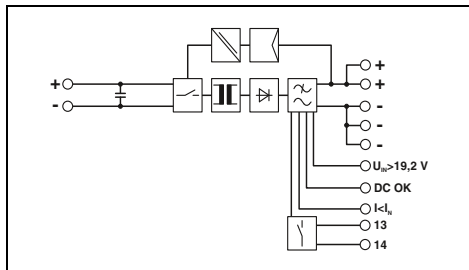

Technical data

24 V DC  
18 V DC ... 32 V DC  
28 A (24 V, I<sub>BOOST</sub>)  
< 26 A / < 11 A<sup>2s</sup>  
> 10 ms (24 V DC)

24 V DC ±1 %  
18 V DC ... 29.5 V DC (> 24 V constant capacity)

20 A / 25 A / 120 A  
B2 / B4 / B6 / B10 / B16 / C2 / C4 / C6  
Yes / Yes  
2.2 W / 39 W  
> 93%  
< 20 mV<sub>PP</sub>

LED, active switching output, relay contact  
LED, active switching output  
LED, active switching output

1.7 kg / 82 x 130 x 125 mm  
Alignable: 5 mm horizontally, 15 mm next to active components, 50 mm vertically  
Screw connection  
0.5 - 16 mm<sup>2</sup> / 0.5 - 16 mm<sup>2</sup> / 8 - 6  
0.2 - 6 mm<sup>2</sup> / 0.2 - 4 mm<sup>2</sup> / 12 - 10  
0.2 - 2.5 mm<sup>2</sup> / 0.2 - 2.5 mm<sup>2</sup> / 24 - 12  
IP20 / III  
> 554000 h (40°C)  
-25°C ... 70°C (> 60°C derating: 2.5%/K, startup at -40°C type-tested)  
≤ 95% (at 25°C, non-condensing)

1 kV (routine test) / 1.5 kV (type test)  
Conformance with EMC Directive 2004/108/EC  
EN 60950-1/VDE 0805 (SELV)  
EN 50178/VDE 0160 (PELV)  
DIN VDE 0100-410  
UL/C-UL listed UL 508, UL/C-UL Recognized UL 60950, UL ANSI/ISA-12.12.01 Class I, Division 2, Groups A, B, C, D (Hazardous Location)

Technical data

24 V DC  
18 V DC ... 32 V DC  
6 A (24 V, I<sub>BOOST</sub>)  
< 15 A / < 0.5 A<sup>2s</sup>  
> 10 ms (24 V DC)

12 V DC ±1 %  
5 V DC ... 18 V DC (> 12 V constant capacity)

8 A / 10 A / 48 A  
B2 / B4 / C2  
Yes / Yes  
2 W / 10.5 W  
> 90%  
< 20 mV<sub>PP</sub>

LED, active switching output  
LED, active switching output  
LED, active switching output

0.7 kg / 32 x 130 x 125 mm  
Alignable: 5 mm horizontally, 15 mm next to active components, 50 mm vertically  
Plug-in screw connection  
0.2 - 2.5 mm<sup>2</sup> / 0.2 - 2.5 mm<sup>2</sup> / 24 - 12  
0.2 - 2.5 mm<sup>2</sup> / 0.2 - 2.5 mm<sup>2</sup> / 24 - 12  
0.2 - 2.5 mm<sup>2</sup> / 0.2 - 2.5 mm<sup>2</sup> / 24 - 12  
IP20 / III  
> 843000 h (40°C)  
-25°C ... 70°C (> 60°C derating: 2.5%/K, startup at -40°C type-tested)  
≤ 95% (at 25°C, non-condensing)

1 kV (routine test) / 1.5 kV (type test)  
Conformance with EMC Directive 2004/108/EC  
EN 60950-1/VDE 0805 (SELV)  
EN 50178/VDE 0160 (PELV)  
DIN VDE 0100-410  
UL/C-UL listed UL 508, UL/C-UL Recognized UL 60950, UL ANSI/ISA-12.12.01 Class I, Division 2, Groups A, B, C, D (Hazardous Location)

Technical data

24 V DC  
18 V DC ... 32 V DC  
14 A (24 V, I<sub>BOOST</sub>)  
< 15 A / 3 A<sup>2s</sup>  
> 12 ms (24 V DC)

48 V DC ±1 %  
30 V DC ... 56 V DC (> 48 V constant capacity)

5 A / 6.25 A / 30 A  
B2 / B4 / C2  
Yes / Yes  
5.2 W / 21 W  
> 92.5%  
< 20 mV<sub>PP</sub>

LED, active switching output, relay contact  
LED, active switching output  
LED, active switching output

0.9 kg / 48 x 130 x 125 mm  
Alignable: 5 mm horizontally, 15 mm next to active components, 50 mm vertically  
Plug-in screw connection  
0.2 - 2.5 mm<sup>2</sup> / 0.2 - 2.5 mm<sup>2</sup> / 24 - 12  
0.2 - 2.5 mm<sup>2</sup> / 0.2 - 2.5 mm<sup>2</sup> / 24 - 12  
0.2 - 2.5 mm<sup>2</sup> / 0.2 - 2.5 mm<sup>2</sup> / 24 - 12  
IP20 / III  
> 761000 h (40°C)  
-25°C ... 70°C (> 60°C derating: 2.5%/K, startup at -40°C type-tested)  
≤ 95% (at 25°C, non-condensing)

1 kV (routine test) / 1.5 kV (type test)  
Conformance with EMC Directive 2004/108/EC  
EN 60950-1/VDE 0805 (SELV)  
EN 50178/VDE 0160 (PELV)  
DIN VDE 0100-410  
UL/C-UL listed UL 508, UL/C-UL Recognized UL 60950, UL ANSI/ISA-12.12.01 Class I, Division 2, Groups A, B, C, D (Hazardous Location)

Ordering data

Type	Order No.	Pcs. / Pkt.
QUINT-PS/24DC/24DC/20	2320102	1

Ordering data

Type	Order No.	Pcs. / Pkt.
QUINT-PS/24DC/12DC/ 8	2320115	1

Ordering data

Type	Order No.	Pcs. / Pkt.
QUINT-PS/24DC/48DC/ 5	2320128	1

#### QUINT POWER, 12 V DC input

- Support conversion to various voltage levels
- Constant voltage: output voltage regenerated even at the end of long cables
- Electrical isolation: for setting up independent supply systems
- SFB technology: quick tripping of standard circuit breakers, thanks to the dynamic power reserve with up to 6 times the nominal current for 12 ms
- Reliable starting of difficult loads thanks to the static POWER BOOST power reserve with up to 125% of the nominal current permanently
- Preventive function monitoring warns against critical operating states before errors occur



DC/DC converter,  
12 V DC/24 V DC, 5 A

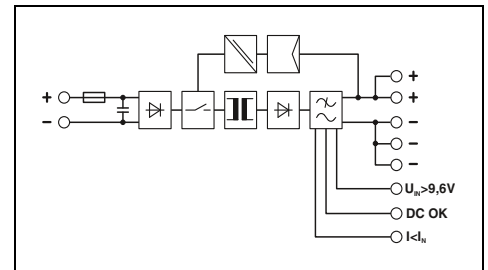

#### Technical data

<b>Input data</b>	12 V DC 9 V DC ... 18 V DC 15 A (12 V, I <sub>BOOST</sub> ) < 15 A / < 0.3 A <sup>2</sup> s > 3 ms (12 V DC)		
Nominal input voltage range			
Input voltage range			
Current consumption (POWER BOOST)			
Inrush current limitation at 25°C (typ.) / I <sup>2</sup> t			
Mains buffering (I <sub>N</sub> , typ.)			
<b>Output data</b>	24 V DC ±1 % 18 V DC ... 29.5 V DC (> 24 V constant capacity)		
Nominal output voltage			
Setting range of the output voltage			
Output current / POWER BOOST / SFB (12 ms)	5 A / 6.25 A / 30 A		
Magnetic fuse tripping	B2 / B4 / C2		
Can be connected in parallel / series	Yes / Yes		
Max. power dissipation (no load / nominal load)	2 W / 13.5 W		
Efficiency (typ.)	> 90%		
Residual ripple	< 75 mV <sub>pp</sub>		
<b>Signaling</b>	LED, active switching output LED, active switching output LED, active switching output		
Signaling DC OK			
Boost signaling			
U <sub>N</sub> signaling			
<b>General data</b>	0.7 kg / 32 x 130 x 125 mm Alignable: 5 mm horizontally, 15 mm next to active components, 50 mm vertically		
Weight / Dimensions W x H x D			
Spacing when mounting			
Connection method	Plug-in screw connection		
Input connection data (solid / stranded / AWG)	0.2 - 2.5 mm <sup>2</sup> / 0.2 - 2.5 mm <sup>2</sup> / 24 - 12		
Output connection data (solid / stranded / AWG)	0.2 - 2.5 mm <sup>2</sup> / 0.2 - 2.5 mm <sup>2</sup> / 24 - 12		
Signal connection data (solid / stranded / AWG)	0.2 - 2.5 mm <sup>2</sup> / 0.2 - 2.5 mm <sup>2</sup> / 24 - 12		
Degree of protection / Protection class	IP20 / III		
MTBF (IEC 61709, SN 29500)	> 1005000 h (40°C)		
Ambient temperature (operation)	-25°C ... 70°C (> 60°C derating: 2.5%/K, startup at -40°C type-tested)		
Max. permissible relative humidity (operation)	≤ 95% (at 25°C, non-condensing)		
<b>Standards/regulations</b>	1 kV (routine test) / 1.5 kV (type test) Conformance with EMC Directive 2004/108/EC EN 60950-1/VDE 0805 (SELV) EN 50178/VDE 0160 (PELV) DIN VDE 0100-410 UL/C-UL listed UL 508, UL/C-UL Recognized UL 60950, UL ANSI/ISA-12.12.01 Class I, Division 2, Groups A, B, C, D (Hazardous Location)		
Insulation voltage input/output			
Electromagnetic compatibility			
Electrical safety			
Electronic equipm. for electrical power installations			
Safe isolation			
UL approvals			
<b>Ordering data</b>			
<b>Description</b>	<b>Type</b>	<b>Order No.</b>	<b>Pcs. / Pkt.</b>
DC/DC converter, primary-switched	QUINT-PS/12DC/24DC/ 5	2320131	1

new



DC/DC converter,  
12 V DC/12 V DC, 8 A

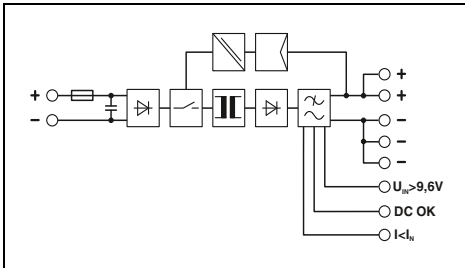

### Technical data

12 V DC  
9 V DC ... 18 V DC  
12 A (12 V,  $I_{BOOST}$ )  
< 6 A / < 0.6 A<sup>2</sup>s  
> 3 ms (12 V DC)

12 V DC  $\pm 1\%$   
5 V DC ... 18 V DC (> 12 V constant capacity)

8 A / 10 A / 48 A  
B2 / B4 / C2  
Yes / Yes  
1.5 W / 11.8 W  
> 89%  
< 20 mV<sub>PP</sub>

LED, active switching output  
LED, active switching output  
LED, active switching output

0.8 kg / 32 x 130 x 125 mm  
Alignable: 5 mm horizontally, 15 mm next to active components,  
50 mm vertically  
Plug-in screw connection  
0.2 - 2.5 mm<sup>2</sup> / 0.2 - 2.5 mm<sup>2</sup> / 24 - 12  
0.2 - 2.5 mm<sup>2</sup> / 0.2 - 2.5 mm<sup>2</sup> / 24 - 12  
0.2 - 2.5 mm<sup>2</sup> / 0.2 - 2.5 mm<sup>2</sup> / 24 - 12  
IP20 / III  
> 920000 h (40°C)  
-25°C ... 70°C (> 60°C derating: 2.5%/K,  
startup at -40°C type-tested)  
≤ 95% (at 25°C, non-condensing)

1 kV (routine test) / 1.5 kV (type test)  
Conformance with EMC Directive 2004/108/EC  
EN 60950-1/VDE 0805 (SELV)  
EN 50178/VDE 0160 (PELV)  
DIN VDE 0100-410  
UL/C-UL listed UL 508, UL/C-UL Recognized UL 60950

### Ordering data

Type	Order No.	Pcs. / Pkt.
QUINT-PS/12DC/12DC/8	2905007	1

# Power supplies and UPS

## DC/DC converters

### QUINT DC/DC converters

#### QUINT POWER, 48 V DC to 110 V DC input

- Support conversion to various voltage levels
- Constant voltage: output voltage regenerated even at the end of long cables
- Electrical isolation: for setting up independent supply systems
- SFB technology: quick tripping of standard circuit breakers, thanks to the dynamic power reserve with up to 6 times the nominal current for 12 ms
- Reliable starting of difficult loads thanks to the static POWER BOOST power reserve with up to 125% of the nominal current permanently
- Preventive function monitoring warns against critical operating states before errors occur



DC/DC converter,  
48 V DC/24 V DC, 5 A

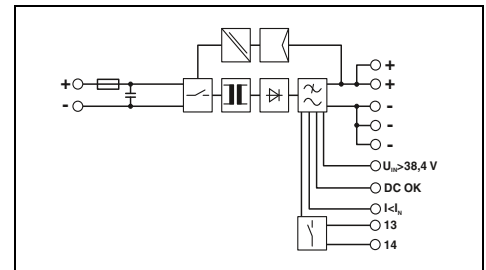

#### Technical data

<b>Input data</b>	48 V DC 30 V DC ... 60 V DC 3.5 A (48 V DC) < 5 A / < 0.2 A <sup>2</sup> s > 14 ms (48 V DC)
Nominal input voltage range	
Input voltage range	
Current consumption (POWER BOOST)	
Inrush current limitation at 25°C (typ.) / I <sup>2</sup> t	
Mains buffering (I <sub>N</sub> , typ.)	
<b>Output data</b>	24 V DC ±1 % 18 V DC ... 29.5 V DC (> 24 V constant capacity)
Nominal output voltage	
Setting range of the output voltage	
Output current / POWER BOOST / SFB (12 ms)	5 A / 6.25 A / 30 A
Magnetic fuse tripping	B2 / B4 / C2
Can be connected in parallel / series	Yes / Yes
Max. power dissipation (no load / nominal load)	2.7 W / 11 W
Efficiency (typ.)	> 91.5%
Residual ripple	< 25 mV <sub>pp</sub>
<b>Signaling</b>	LED, active switching output LED, active switching output LED, active switching output
Signaling DC OK	
Boost signaling	
U <sub>N</sub> signaling	
<b>General data</b>	0.7 kg / 32 x 130 x 125 mm Alignable: 5 mm horizontally, 15 mm next to active components, 50 mm vertically
Weight / Dimensions W x H x D	
Spacing when mounting	
Connection method	Plug-in screw connection
Input connection data (solid / stranded / AWG)	0.2 - 2.5 mm <sup>2</sup> / 0.2 - 2.5 mm <sup>2</sup> / 24 - 12
Output connection data (solid / stranded / AWG)	0.2 - 2.5 mm <sup>2</sup> / 0.2 - 2.5 mm <sup>2</sup> / 24 - 12
Signal connection data (solid / stranded / AWG)	0.2 - 2.5 mm <sup>2</sup> / 0.2 - 2.5 mm <sup>2</sup> / 24 - 12
Degree of protection / Protection class	IP20 / III
MTBF (IEC 61709, SN 29500)	> 995000 h (40°C)
Ambient temperature (operation)	-25°C ... 70°C (> 60°C derating: 2.5%/K, startup at -40°C type-tested)
Max. permissible relative humidity (operation)	≤ 95% (at 25°C, non-condensing)
<b>Standards/regulations</b>	1 kV (routine test) / 1.5 kV (type test) Conformance with EMC Directive 2004/108/EC EN 60950-1/VDE 0805 (SELV) EN 50178/VDE 0160 (PELV) DIN VDE 0100-410 UL/C-UL listed UL 508, UL/C-UL Recognized UL 60950, UL ANSI/ISA-12.12.01 Class I, Division 2, Groups A, B, C, D (Hazardous Location)
Insulation voltage input/output	
Electromagnetic compatibility	
Electrical safety	
Electronic equipm. for electrical power installations	
Safe isolation	
UL approvals	
<b>Ordering data</b>	
<b>Description</b>	<b>Type</b>
DC/DC converter, primary-switched	QUINT-PS/48DC/24DC/ 5
	<b>Order No.</b>
	2320144
	<b>Pcs. / Pkt.</b>
	1





new

DC/DC converter,  
48 V DC/48 V DC, 5 A

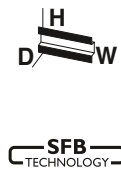

new

DC/DC converter,  
60 - 72 V DC/24 V DC, 10 A



new

DC/DC converter,  
96 - 110 V DC/24 V DC, 10 A

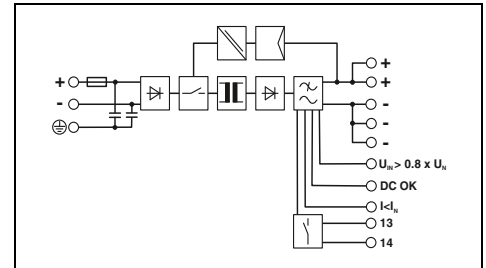
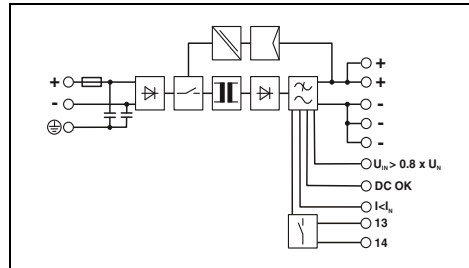
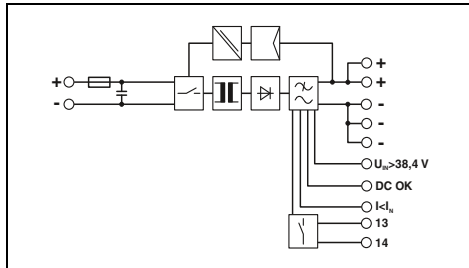

Technical data

48 V DC  
30 V DC ... 60 V DC  
7 A (48 V, I<sub>BOOST</sub>)  
< 6 A / 0.3 A<sup>2</sup>s  
> 10 ms (48 V DC)

48 V DC ±1 %  
30 V DC ... 56 V DC (> 48 V constant capacity)

5 A / 6.25 A / 30 A  
B2 / B4 / C2  
Yes / Yes  
2.7 W / 20 W  
> 93%  
< 20 mV<sub>PP</sub>

LED, active switching output  
LED, active switching output  
LED, active switching output

0.9 kg / 48 x 130 x 125 mm  
Alignable: 5 mm horizontally, 15 mm next to active components, 50 mm vertically  
Plug-in screw connection  
0.2 - 2.5 mm<sup>2</sup> / 0.2 - 2.5 mm<sup>2</sup> / 24 - 12  
0.2 - 2.5 mm<sup>2</sup> / 0.2 - 2.5 mm<sup>2</sup> / 24 - 12  
0.2 - 2.5 mm<sup>2</sup> / 0.2 - 2.5 mm<sup>2</sup> / 24 - 12  
IP20 / III  
> 872000 h (40°C)  
-25°C ... 70°C (> 60°C derating: 2.5%/K, startup at -40°C type-tested)  
≤ 95% (at 25°C, non-condensing)

1 kV (routine test) / 1.5 kV (type test)  
Conformance with EMC Directive 2004/108/EC  
EN 60950-1/VDE 0805 (SELV)  
EN 50178/VDE 0160 (PELV)  
DIN VDE 0100-410  
UL/C-UL listed UL 508, UL/C-UL Recognized UL 60950

Technical data

60 V DC ... 72 V DC  
42 V DC ... 96 V DC  
5.6 A (60 V DC) / 4.7 A (72 V DC)  
< 9 A / 0.64 A<sup>2</sup>s  
> 10 ms (60 V DC)

24 V DC ±1 %  
18 V DC ... 29.5 V DC (> 24 V constant capacity)

10 A / 12.5 A / 60 A  
B2 / B4 / B6  
Yes / Yes  
4 W (U<sub>IN</sub> 60 V DC) / 24 W (U<sub>IN</sub> 60 V DC)  
> 91% (U<sub>IN</sub> 60 V DC / U<sub>OUT</sub> 24 V DC)  
< 20 mV<sub>PP</sub>

LED, active switching output, relay contact  
LED, active switching output  
LED, active switching output

1 kg / 48 x 130 x 125 mm  
Alignable: 5 mm horizontally, 15 mm next to active components, 50 mm vertically  
Plug-in screw connection  
0.2 - 2.5 mm<sup>2</sup> / 0.2 - 2.5 mm<sup>2</sup> / 24 - 12  
0.2 - 2.5 mm<sup>2</sup> / 0.2 - 2.5 mm<sup>2</sup> / 24 - 12  
0.2 - 2.5 mm<sup>2</sup> / 0.2 - 2.5 mm<sup>2</sup> / 24 - 12  
IP20 / I  
> 765000 h (40°C)  
-25°C ... 70°C (> 60°C derating: 2.5%/K, startup at -40°C type-tested)  
≤ 95% (at 25°C, non-condensing)

1 kV (routine test) / 1.5 kV (type test)  
Conformance with EMC Directive 2004/108/EC  
EN 60950-1/VDE 0805 (SELV)  
EN 50178/VDE 0160 (PELV)  
DIN VDE 0100-410  
UL/C-UL listed UL 508, UL/C-UL Recognized UL 60950

Technical data

96 V DC ... 110 V DC  
67.2 V DC ... 154 V DC  
3.5 A (96 V DC) / 3.1 A (110 V DC)  
< 10 A / 0.37 A<sup>2</sup>s  
> 10 ms (96 V DC)

24 V DC ±1 %  
18 V DC ... 29.5 V DC (> 24 V constant capacity)

10 A / 12.5 A / 60 A  
B2 / B4 / B6  
Yes / Yes  
4 W (U<sub>IN</sub> 110 V DC) / 22 W (U<sub>IN</sub> 110 V DC)  
> 92% (U<sub>IN</sub> 96 V DC / U<sub>OUT</sub> 24 V DC)  
< 20 mV<sub>PP</sub>

LED, active switching output, relay contact  
LED, active switching output  
LED, active switching output

0.9 kg / 48 x 130 x 125 mm  
Alignable: 5 mm horizontally, 15 mm next to active components, 50 mm vertically  
Plug-in screw connection  
0.2 - 2.5 mm<sup>2</sup> / 0.2 - 2.5 mm<sup>2</sup> / 24 - 12  
0.2 - 2.5 mm<sup>2</sup> / 0.2 - 2.5 mm<sup>2</sup> / 24 - 12  
0.2 - 2.5 mm<sup>2</sup> / 0.2 - 2.5 mm<sup>2</sup> / 24 - 12  
IP20 / I  
> 772000 h (40°C)  
-25°C ... 70°C (> 60°C derating: 2.5%/K, startup at -40°C type-tested)  
≤ 95% (at 25°C, non-condensing)

1 kV (routine test) / 1.5 kV (type test)  
Conformance with EMC Directive 2004/108/EC  
EN 60950-1/VDE 0805 (SELV)  
EN 50178/VDE 0160 (PELV)  
DIN VDE 0100-410  
UL/C-UL listed UL 508, UL/C-UL Recognized UL 60950

Ordering data

Type	Order No.	Pcs. / Pkt.
QUINT-PS/48DC/48DC/5	2905008	1

Ordering data

Type	Order No.	Pcs. / Pkt.
QUINT-PS/60-72DC/24DC/10	2905009	1

Ordering data

Type	Order No.	Pcs. / Pkt.
QUINT-PS/96-110DC/24DC/10	2905010	1

# Power supplies and UPS

## DC/DC converters

### QUINT DC/DC converters for extreme requirements

#### QUINT POWER with protective coating

With ATEX approval for superior system availability under extreme ambient conditions, such as dust, dirt, corrosive gases, and 100% humidity

- Complies with standard EN 60079-15 and may be installed in a potentially explosive area
- Suitable for use in Class I, Division 2
- OVP (Over Voltage Protection) limits surge voltages to 32 V
- Temperature range from -40°C to +70°C, Groups A, B, C, D



DC/DC converter, with protective coating, 24 V DC/24 V DC, 5 A



DC/DC converter, with protective coating, 24 V DC/24 V DC, 10 A

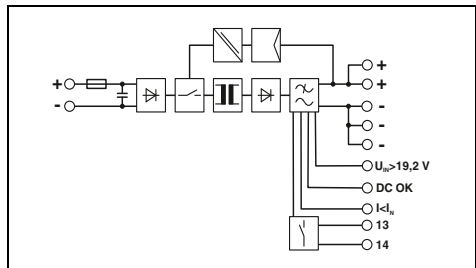
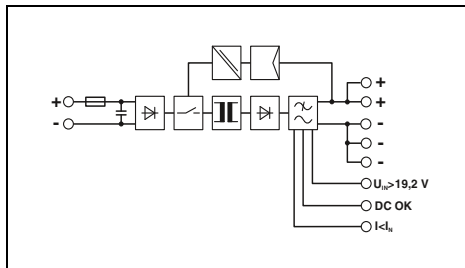

#### Technical data

Input data	
Nominal input voltage range	24 V DC
Input voltage range	18 V DC ... 32 V DC
Current consumption (POWER BOOST)	7 A (24 V, I <sub>BOOST</sub> )
Inrush current limitation at 25°C (typ.) / I <sup>2</sup> t	< 15 A / < 0.5 A <sup>2</sup> s
Mains buffering (I <sub>N</sub> , typ.)	> 10 ms (24 V DC)
Output data	
Nominal output voltage	24 V DC ±1 %
Setting range of the output voltage	18 V DC ... 29.5 V DC (> 24 V constant capacity)
Output current / POWER BOOST / SFB (12 ms)	
Magnetic fuse tripping	5 A / 6.25 A / 30 A
Can be connected in parallel / series	B2 / B4 / C2
Max. power dissipation (no load / nominal load)	Yes / Yes
Efficiency (typ.)	2.4 W / 11.4 W
Residual ripple	> 92%
Signaling	< 20 mV <sub>pp</sub>
Signaling DC OK	LED, active switching output
Boost signaling	LED, active switching output
U <sub>N</sub> signaling	LED, active switching output
General data	
Weight / Dimensions W x H x D	0.7 kg / 32 x 130 x 125 mm
Spacing when mounting	Alignable: 5 mm horizontally, 15 mm next to active components, 50 mm vertically
Connection method	
Input connection data (solid / stranded / AWG)	Plug-in screw connection
Output connection data (solid / stranded / AWG)	0.2 - 2.5 mm <sup>2</sup> / 0.2 - 2.5 mm <sup>2</sup> / 24 - 12
Signal connection data (solid / stranded / AWG)	0.2 - 2.5 mm <sup>2</sup> / 0.2 - 2.5 mm <sup>2</sup> / 24 - 12
Degree of protection / Protection class	0.2 - 2.5 mm <sup>2</sup> / 0.2 - 2.5 mm <sup>2</sup> / 24 - 12
MTBF (IEC 61709, SN 29500)	IP20 / III
Ambient temperature (operation)	> 890000 h (40°C)
Max. permissible relative humidity (operation)	-25°C ... 70°C (> 60°C derating: 2.5%/K, startup at -40°C type-tested)
Standards/regulations	100% (at 25°C, non-condensing)
Insulation voltage input/output	1 kV (routine test) / 1.5 kV (type test)
Electromagnetic compatibility	Conformance with EMC Directive 2004/108/EC
Electrical safety	EN 60950-1/VDE 0805 (SELV)
Electronic equipm. for electrical power installations	EN 50178/VDE 0160 (PELV)
Safe isolation	DIN VDE 0100-410
Rail applications	EN 50121-4 / EN 50155
UL approvals	UL/C-UL listed UL 508, UL/C-UL Recognized UL 60950, UL ANSI/ISA-12.12.01 Class I, Division 2, Groups A, B, C, D (Hazardous Location)

#### Ordering data

Description	Type	Order No.	Pcs. / Pkt.
DC/DC converter, primary-switched, dip-coated	QUINT-PS/24DC/24DC/5/CO	2320542	1

#### Technical data

Input data	
Nominal input voltage range	24 V DC
Input voltage range	18 V DC ... 32 V DC
Current consumption (POWER BOOST)	14 A (24 V, I <sub>BOOST</sub> )
Inrush current limitation at 25°C (typ.) / I <sup>2</sup> t	< 15 A / < 2.7 A <sup>2</sup> s
Mains buffering (I <sub>N</sub> , typ.)	> 10 ms (24 V DC)
Output data	
Nominal output voltage	24 V DC ±1 %
Setting range of the output voltage	18 V DC ... 29.5 V DC (> 24 V constant capacity)
Output current / POWER BOOST / SFB (12 ms)	
Magnetic fuse tripping	10 A / 12.5 A / 60 A
Can be connected in parallel / series	B2 / B4 / B6 / C2 / C4
Max. power dissipation (no load / nominal load)	Yes / Yes
Efficiency (typ.)	1.6 W / 24 W
Residual ripple	> 92%
Signaling	< 20 mV <sub>pp</sub>
Signaling DC OK	LED, active switching output, relay contact
Boost signaling	LED, active switching output
U <sub>N</sub> signaling	LED, active switching output
General data	
Weight / Dimensions W x H x D	0.9 kg / 48 x 130 x 125 mm
Spacing when mounting	Alignable: 5 mm horizontally, 15 mm next to active components, 50 mm vertically
Connection method	
Input connection data (solid / stranded / AWG)	Plug-in screw connection
Output connection data (solid / stranded / AWG)	0.2 - 2.5 mm <sup>2</sup> / 0.2 - 2.5 mm <sup>2</sup> / 24 - 12
Signal connection data (solid / stranded / AWG)	0.2 - 2.5 mm <sup>2</sup> / 0.2 - 2.5 mm <sup>2</sup> / 24 - 12
Degree of protection / Protection class	0.2 - 2.5 mm <sup>2</sup> / 0.2 - 2.5 mm <sup>2</sup> / 24 - 12
MTBF (IEC 61709, SN 29500)	IP20 / III
Ambient temperature (operation)	> 763000 h (40°C)
Max. permissible relative humidity (operation)	-25°C ... 70°C (> 60°C derating: 2.5%/K, startup at -40°C type-tested)
Standards/regulations	100% (at 25°C, non-condensing)
Insulation voltage input/output	1 kV (routine test) / 1.5 kV (type test)
Electromagnetic compatibility	Conformance with EMC Directive 2004/108/EC
Electrical safety	EN 60950-1/VDE 0805 (SELV)
Electronic equipm. for electrical power installations	EN 50178/VDE 0160 (PELV)
Safe isolation	DIN VDE 0100-410
Rail applications	EN 50121-4 / EN 50155
UL approvals	UL/C-UL listed UL 508, UL/C-UL Recognized UL 60950, UL ANSI/ISA-12.12.01 Class I, Division 2, Groups A, B, C, D (Hazardous Location)

#### Ordering data

Description	Type	Order No.	Pcs. / Pkt.
DC/DC converter, primary-switched, dip-coated	QUINT-PS/24DC/24DC/10/CO	2320555	1



DC/DC converter,  
with protective coating,  
24 V DC/24 V DC, 20 A

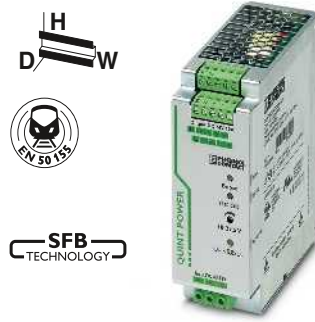

DC/DC converter,  
with protective coating,  
60 - 72 V DC/24 V DC, 10 A



DC/DC converter,  
with protective coating,  
96 - 110 V DC/24 V DC, 10 A

UL, CE, ENEC, ETL, ClassNK, Ex: Ex, Ex, Ex

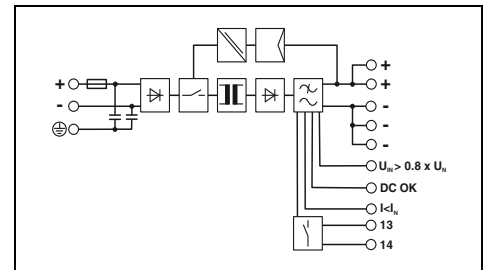
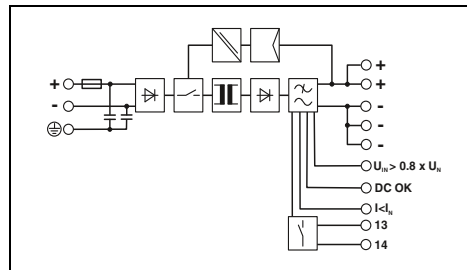
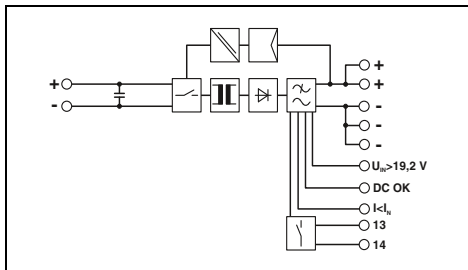

Technical data		
24 V DC		
18 V DC ... 32 V DC		
28 A (24 V, I <sub>BOOST</sub> )		
< 26 A / < 11 A <sup>2s</sup>		
> 10 ms (24 V DC)		
24 V DC ±1 %		
18 V DC ... 29.5 V DC (> 24 V constant capacity)		
20 A / 25 A / 120 A		
B2 / B4 / B6 / B10 / B16 / C2 / C4 / C6		
Yes / Yes		
2.2 W / 39 W		
> 92%		
< 20 mV <sub>PP</sub>		
LED, active switching output, relay contact		
LED, active switching output		
LED, active switching output		
1.7 kg / 82 x 130 x 125 mm		
Alignable: 5 mm horizontally, 15 mm next to active components, 50 mm vertically		
Screw connection		
0.5 - 16 mm <sup>2</sup> / 0.5 - 16 mm <sup>2</sup> / 8 - 6		
0.2 - 6 mm <sup>2</sup> / 0.2 - 4 mm <sup>2</sup> / 12 - 10		
0.2 - 2.5 mm <sup>2</sup> / 0.2 - 2.5 mm <sup>2</sup> / 24 - 12		
IP20 / III		
> 554000 h (40°C)		
-25°C ... 70°C (> 60°C derating: 2.5%/K, startup at -40°C type-tested)		
100% (at 25°C, non-condensing)		
1 kV (routine test) / 1.5 kV (type test)		
Conformance with EMC Directive 2004/108/EC		
EN 60950-1/VDE 0805 (SELV)		
EN 50178/VDE 0160 (PELV)		
DIN VDE 0100-410		
EN 50121-4 / EN 50155		
UL/C-UL listed UL 508, UL/C-UL Recognized UL 60950, UL ANSI/ISA-12.12.01 Class I, Division 2, Groups A, B, C, D (Hazardous Location)		

Technical data		
60 V DC ... 72 V DC		
42 V DC ... 96 V DC		
5.6 A (60 V DC) / 4.7 A (72 V DC)		
< 9 A / 0.64 A <sup>2s</sup>		
> 10 ms (60 V DC)		
24 V DC ±1 %		
18 V DC ... 29.5 V DC (> 24 V constant capacity)		
10 A / 12.5 A / 60 A		
B2 / B4 / B6		
Yes / Yes		
4 W (U <sub>IN</sub> 60 V DC) / 24 W (U <sub>IN</sub> 60 V DC)		
> 91% (U <sub>IN</sub> 60 V DC / U <sub>OUT</sub> 24 V DC)		
< 20 mV <sub>PP</sub>		
LED, active switching output, relay contact		
LED, active switching output		
LED, active switching output		
1 kg / 48 x 130 x 125 mm		
Alignable: 5 mm horizontally, 15 mm next to active components, 50 mm vertically		
Plug-in screw connection		
0.2 - 2.5 mm <sup>2</sup> / 0.2 - 2.5 mm <sup>2</sup> / 24 - 12		
0.2 - 2.5 mm <sup>2</sup> / 0.2 - 2.5 mm <sup>2</sup> / 24 - 12		
0.2 - 2.5 mm <sup>2</sup> / 0.2 - 2.5 mm <sup>2</sup> / 24 - 12		
IP20 / I		
> 765000 h (40°C)		
-25°C ... 70°C (> 60°C derating: 2.5%/K, startup at -40°C type-tested)		
100% (at 25°C, non-condensing)		
1 kV (routine test) / 1.5 kV (type test)		
Conformance with EMC Directive 2004/108/EC		
EN 60950-1/VDE 0805 (SELV)		
EN 50178/VDE 0160 (PELV)		
DIN VDE 0100-410		
EN 50121-4 / EN 50155		
UL/C-UL listed UL 508, UL/C-UL Recognized UL 60950		

Technical data		
96 V DC ... 110 V DC		
67.2 V DC ... 154 V DC		
3.5 A (96 V DC) / 3.1 A (110 V DC)		
< 10 A / 0.37 A <sup>2s</sup>		
> 10 ms (96 V DC)		
24 V DC ±1 %		
18 V DC ... 29.5 V DC (> 24 V constant capacity)		
10 A / 12.5 A / 60 A		
B2 / B4 / B6		
Yes / Yes		
4 W (U <sub>IN</sub> 110 V DC) / 22 W (U <sub>IN</sub> 110 V DC)		
> 92% (U <sub>IN</sub> 96 V DC / U <sub>OUT</sub> 24 V DC)		
< 20 mV <sub>PP</sub>		
LED, active switching output, relay contact		
LED, active switching output		
LED, active switching output		
0.9 kg / 48 x 130 x 125 mm		
Alignable: 5 mm horizontally, 15 mm next to active components, 50 mm vertically		
Plug-in screw connection		
0.2 - 2.5 mm <sup>2</sup> / 0.2 - 2.5 mm <sup>2</sup> / 24 - 12		
0.2 - 2.5 mm <sup>2</sup> / 0.2 - 2.5 mm <sup>2</sup> / 24 - 12		
0.2 - 2.5 mm <sup>2</sup> / 0.2 - 2.5 mm <sup>2</sup> / 24 - 12		
IP20 / I		
> 772000 h (40°C)		
-25°C ... 70°C (> 60°C derating: 2.5%/K, startup at -40°C type-tested)		
100% (at 25°C, non-condensing)		
1 kV (routine test) / 1.5 kV (type test)		
Conformance with EMC Directive 2004/108/EC		
EN 60950-1/VDE 0805 (SELV)		
EN 50178/VDE 0160 (PELV)		
DIN VDE 0100-410		
EN 50121-4 / EN 50155		
UL/C-UL listed UL 508, UL/C-UL Recognized UL 60950		

Ordering data		
Type	Order No.	Pcs. / Pkt.
QUINT-PS/24DC/24DC/20/CO	2320568	1

Ordering data		
Type	Order No.	Pcs. / Pkt.
QUINT-PS/60-72DC/24DC/10/CO	2905011	1

Ordering data		
Type	Order No.	Pcs. / Pkt.
QUINT-PS/96-110DC/24DC/10/CO	2905012	1

# Power supplies and UPS

## DC/DC converters

### MINI DC/DC converters

#### MINI POWER, 12 V DC to 60 V DC input

- Support conversion to various voltage levels
- Constant voltage: output voltage regenerated even at the end of long cables
- Electrical isolation: for setting up independent supply systems

#### MINI AC power terminal

- For supplying MINI DC/DC converters from unregulated AC networks
- The AC voltage of a transformer is rectified and filtered



DC/DC converter,  
12 - 24 V DC / 24 V DC, 1 A



DC/DC converter,  
12 - 24 V DC / 5 - 15 V DC, 2 A

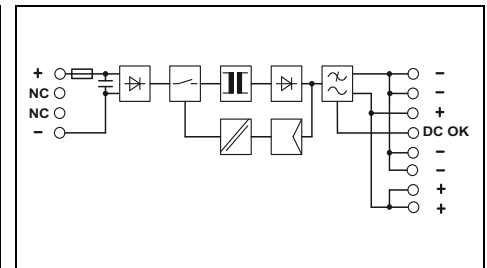
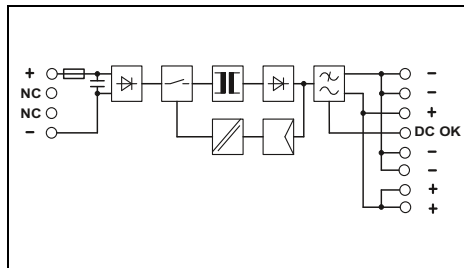

#### Technical data

Input data
Nominal input voltage range
Input voltage range
Current consumption (nominal load)
Inrush current limitation at 25°C (typ.) / I <sub>st</sub>
Output data
Nominal output voltage
Setting range of the output voltage
Output current
Can be connected in parallel / series
Max. power dissipation (no load / nominal load)
Efficiency (typ.)
Residual ripple
Signaling
Signaling DC OK
General data
Weight / Dimensions W x H x D
Spacing when mounting
Connection method
Input connection data (solid / stranded / AWG)
Output connection data (solid / stranded / AWG)
Signal connection data (solid / stranded / AWG)
Degree of protection / Protection class
MTBF (IEC 61709, SN 29500)
Ambient temperature (operation)
Max. permissible relative humidity (operation)
Standards/regulations
Insulation voltage input/output
Electromagnetic compatibility
Electrical safety
Electronic equipm. for electrical power installations
Safe isolation
UL approvals

12 V DC ... 24 V DC
10 V DC ... 32 V DC
2.6 A (12 V DC) / 1.3 A (24 V DC)
< 15 A / 1.8 A <sup>2s</sup>
24 V DC ±1 %
22.5 V DC ... 28.5 V DC (> 24 V constant capacity)
1 A
Yes / Yes
< 1.2 W / < 5 W
> 83% (at 24 V DC and nominal values)
< 30 mV <sub>pp</sub>
LED, active switching output
0.2 kg / 22.5 x 99 x 107 mm
Alignable: horizontally 0 mm, vertically 50 mm
Plug-in screw connection
0.2 - 2.5 mm <sup>2</sup> / 0.2 - 2.5 mm <sup>2</sup> / 24 - 14
0.2 - 2.5 mm <sup>2</sup> / 0.2 - 2.5 mm <sup>2</sup> / 24 - 14
0.2 - 2.5 mm <sup>2</sup> / 0.2 - 2.5 mm <sup>2</sup> / 24 - 14
IP20 / III
> 2569000 h (40°C)
-25°C ... 70°C (> 60°C derating: 2.5%/K)
≤ 95% (at 25°C, non-condensing)
1 kV (routine test) / 1.5 kV (type test)
Conformance with EMC Directive 2004/108/EC
EN 60950-1/VDE 0805 (SELV)
EN 50178/VDE 0160 (PELV)
DIN VDE 0100-410, DIN VDE 0106-101
UL/C-UL listed UL 508, UL/C-UL Recognized UL 60950, UL ANSI/ISA-12.12.01 Class I, Division 2, Groups A, B, C, D (Hazardous Location)

#### Technical data

12 V DC ... 24 V DC
10 V DC ... 32 V DC
2.3 A (12 V DC) / 1.1 A (24 V DC)
< 10 A / 0.2 A <sup>2s</sup>
12 V DC ±1 %
5 V DC ... 15 V DC
2 A
Yes / Yes
< 1 W / < 4.2 W
> 88% (at 24 V DC and nominal values)
< 20 mV <sub>pp</sub>
LED, active switching output
0.2 kg / 22.5 x 99 x 107 mm
Alignable: horizontally 0 mm, vertically 50 mm
Plug-in screw connection
0.2 - 2.5 mm <sup>2</sup> / 0.2 - 2.5 mm <sup>2</sup> / 24 - 14
0.2 - 2.5 mm <sup>2</sup> / 0.2 - 2.5 mm <sup>2</sup> / 24 - 14
0.2 - 2.5 mm <sup>2</sup> / 0.2 - 2.5 mm <sup>2</sup> / 24 - 14
IP20 / III
> 2072000 h (40°C)
-25°C ... 70°C (> +60°C derating)
≤ 95% (at +25°C, non-condensing)
1 kV (routine test) / 1.5 kV (type test)
Conformance with EMC Directive 2004/108/EC
EN 60950-1/VDE 0805 (SELV)
EN 50178/VDE 0160 (PELV)
DIN VDE 0100-410, DIN VDE 0106-101
UL/C-UL listed UL 508, UL/C-UL Recognized UL 60950, UL ANSI/ISA-12.12.01 Class I, Division 2, Groups A, B, C, D (Hazardous Location)

#### Ordering data

Description	Type	Order No.	Pcs. / Pkt.
DC/DC converter, primary-switched	MINI-PS- 12- 24DC/24DC/1	2866284	1

#### Ordering data

Description	Type	Order No.	Pcs. / Pkt.
DC/DC converter, primary-switched	MINI-PS- 12- 24DC/ 5-15DC/2	2320018	1



**DC/DC converter,  
12 - 24 V DC / 48 V DC, 0.7 A**

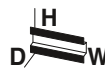

**DC/DC converter,  
48 - 60 V DC / 24 V DC, 1 A**



**AC power terminal for  
MINI DC/DC converter**

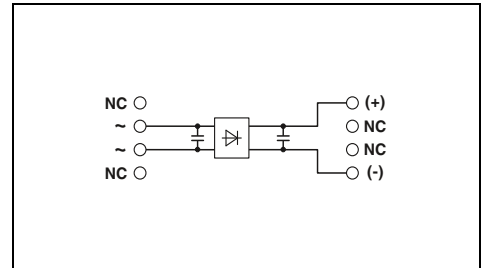
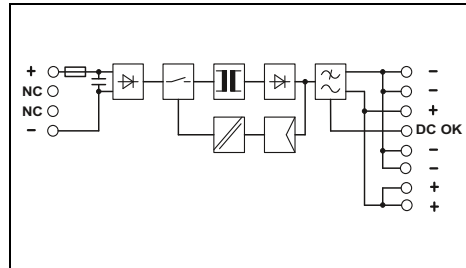
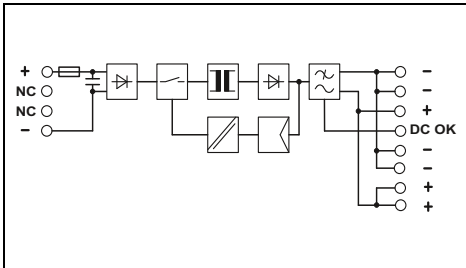

Technical data	
12 V DC ... 24 V DC 10 V DC ... 32 V DC 3.2 A (12 V DC) / 1.6 A (24 V DC) < 10 A / 0.3 A <sup>2</sup> s	
48 V DC ±1 % 30 V DC ... 56 V DC (> 48 V constant capacity)	
0.7 A Yes / Yes < 1.5 W / < 4.5 W > 87% (at 24 V DC and nominal values) < 20 mV <sub>pp</sub>	
LED, active switching output	
0.2 kg / 22.5 x 99 x 107 mm Alignable: horizontally 0 mm, vertically 50 mm Plug-in screw connection 0.2 - 2.5 mm <sup>2</sup> / 0.2 - 2.5 mm <sup>2</sup> / 24 - 14 0.2 - 2.5 mm <sup>2</sup> / 0.2 - 2.5 mm <sup>2</sup> / 24 - 14 0.2 - 2.5 mm <sup>2</sup> / 0.2 - 2.5 mm <sup>2</sup> / 24 - 14 IP20 / III > 1993000 h (40°C) -25°C ... 70°C (> +60°C derating) ≤ 95% (at +25°C, non-condensing)	
1 kV (routine test) / 1.5 kV (type test) Conformance with EMC Directive 2004/108/EC EN 60950-1/VDE 0805 (SELV) EN 50178/VDE 0160 (PELV) DIN VDE 0100-410, DIN VDE 0106-101 UL/C-UL listed UL 508, UL/C-UL Recognized UL 60950, UL ANSI/ISA-12.12.01 Class I, Division 2, Groups A, B, C, D (Hazardous Location)	

Technical data	
48 V DC ... 60 V DC 36 V DC ... 75 V DC 0.6 A (48 V DC) / 0.5 A (60 V DC) < 15 A / 1.8 A <sup>2</sup> s	
24 V DC ±1 % 22.5 V DC ... 28.5 V DC (> 24 V constant capacity)	
1 A Yes / Yes < 1.2 W / < 5 W > 85% (at 60 V DC and nominal values) < 40 mV <sub>pp</sub>	
LED, active switching output	
0.2 kg / 22.5 x 99 x 107 mm Alignable: horizontally 0 mm, vertically 50 mm Plug-in screw connection 0.2 - 2.5 mm <sup>2</sup> / 0.2 - 2.5 mm <sup>2</sup> / 24 - 14 0.2 - 2.5 mm <sup>2</sup> / 0.2 - 2.5 mm <sup>2</sup> / 24 - 14 0.2 - 2.5 mm <sup>2</sup> / 0.2 - 2.5 mm <sup>2</sup> / 24 - 14 IP20 / III > 1147000 h (40°C) -25°C ... 70°C (> 60°C derating: 2.5%/K) ≤ 95% (at 25°C, non-condensing)	
1 kV (routine test) / 1.5 kV (type test) Conformance with EMC Directive 2004/108/EC EN 60950-1/VDE 0805 (SELV) EN 50178/VDE 0160 (PELV) DIN VDE 0100-410, DIN VDE 0106-101 UL/C-UL listed UL 508, UL/C-UL Recognized UL 60950, UL ANSI/ISA-12.12.01 Class I, Division 2, Groups A, B, C, D (Hazardous Location)	

Technical data	
10 V AC ... 42 V AC 10 V AC ... 42 V AC 6.5 A < 45 A / 8 A <sup>2</sup> s	
24 V DC ±1 % -	
3 A Yes / No < 0.04 W / < 6.9 W > 95.7% (at 42 V AC and nominal values) < 3.6 V <sub>pp</sub>	
-	
0.16 kg / 22.5 x 99 x 107 mm Alignable: horizontally 0 mm, vertically 50 mm Plug-in screw connection 0.2 - 2.5 mm <sup>2</sup> / 0.2 - 2.5 mm <sup>2</sup> / 24 - 12 0.2 - 2.5 mm <sup>2</sup> / 0.2 - 2.5 mm <sup>2</sup> / 24 - 12 - / - / - IP20 / III > 18175000 h (40°C) -25°C ... 70°C (> 60°C derating: 2.5%/K) ≤ 95% (at 25°C, non-condensing)	
1 kV (routine test) / 1.5 kV (type test) Conformance with EMC Directive 2004/108/EC EN 60950-1/VDE 0805 (SELV) EN 50178/VDE 0160 (PELV) - UL/C-UL listed UL 508, UL/C-UL Recognized UL 60950	

Ordering data		
Type	Order No.	Pcs. / Pkt.
MINI-PS-12-24DC/48DC/0.7	2320021	1

Ordering data		
Type	Order No.	Pcs. / Pkt.
MINI-PS-48-60DC/24DC/1	2866271	1

Ordering data		
Type	Order No.	Pcs. / Pkt.
MINI-PS-10-42AC/15-60DC/3	2320199	1



### Maximum availability due to redundancy modules

To prevent errors influencing the load in a redundant system and to increase operational reliability, the power supplies must be decoupled from one another using a redundancy module. Phoenix Contact offers various solutions depending on the requirements:

#### Decoupling with QUINT DIODE, UNO DIODE, and STEP DIODE redundancy modules

If the power supply units are decoupled, a short circuit at the output of one of the power supply units or in the supply line from the power supply unit to the diode no longer has any effect on the load.

#### Decoupling and monitoring with TRIO DIODE redundancy modules

The redundancy modules check the output voltages of the power supply units, as well as the wiring up to the redundancy module itself. Should one of these pathways short circuit, the load will continue to be supplied. Cable breaks are also detected and reported.

#### Decoupling, monitoring, and closed-loop control by means of the QUINT ORING active redundancy modules

The QUINT ORING active redundancy modules monitor the entire redundant solution, i.e., the power supply unit voltages, the wiring, decoupling, and the load current. Critical operating states can therefore be detected at an early stage and redundancy can be restored. For example, incorrect wiring or faulty cables are indicated.

QUINT ORING with ACB technology doubles the service life of the redundant system:

As a result of asymmetries, the load is often supplied by one power supply unit, while the other runs in no-load operation. This results in a thermal overload of the working power supply unit and thereby rapid aging. If the power supply unit is operated at half the nominal current, it remains significantly cooler. The ACB technology of the QUINT ORING modules ensures symmetrical loading of the power supplies and thereby up to double the service life of the redundant system.

**i** Your web code: #0153



**QUINT ORING active redundancy module for maximum system availability**

- Constant monitoring of input voltage, output current, and decoupling section
- Preventive function monitoring
  - Consistent redundancy
  - ACB technology doubles the service life
  - Energy savings of 70% by using MOSFETs over diodes

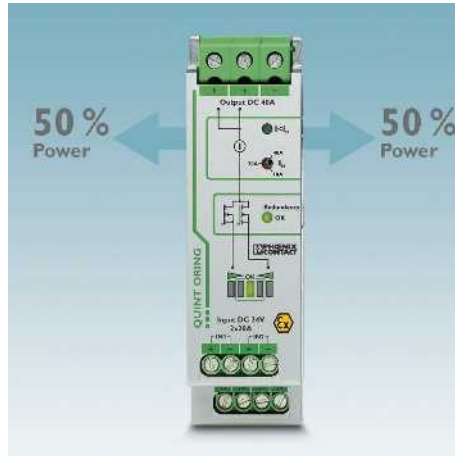

**QUINT ORING and DIODE for extreme requirements**

- The protective coating protects against dust, corrosive gases, and 100% humidity as well as failure caused by corrosion-related creepage currents and electrochemical migration.
- OVP (Over Voltage Protection) limits surge voltages to 32 V
  - Wide temperature range from -40°C to +70°C



**TRIO DIODE redundancy module**

- Permanent redundancy monitoring
- Consistent redundancy up to the load
- Flexible: nominal voltages of 12 V DC to 48 V DC



**QUINT DIODE redundancy module**

- Robust design for currents of up to 60 A
- Consistent redundancy up to the load
- Flexible: nominal voltages of 12 V DC to 48 V DC



**UNO DIODE redundancy module**

- Consistent redundancy up to the load
- Flexible: nominal voltages of 5 V DC to 24 V DC



**STEP DIODE redundancy module**

- Space-saving: overall width of just 18 mm
- Consistent redundancy up to the load
- Flexible: nominal voltages of 5 V DC to 24 V DC

### QUINT ORING

#### QUINT ORING, 24 V DC

- Preventive function monitoring: permanent monitoring of the input voltage, output current, and decoupling section
- Continuous redundancy right through to the load: the use of two positive output terminal blocks makes it possible to devise a redundant wiring concept that runs right through to the load.
- Double the service life of the redundant solution thanks to even load distribution: the ACB (Auto Current Balancing) technology automatically and symmetrically distributes the load current to two power supply units operating in parallel.
- Save energy: decoupling is achieved with MOSFETs and results in energy savings of up to 70% compared with conventional diodes.
- OVP (Over Voltage Protection): surge voltages are limited to 32 V

#### QUINT ORING, with protective coating

With ATEX approval for superior system availability under extreme ambient conditions, such as dust, dirt, corrosive gases, and 100% humidity

- Complies with standard EN 60079-15 and may be installed in a potentially explosive area
- Suitable for use in Class I, Division 2



Active redundancy module, with protective coating,

24 V DC, 2 x 10 A, 1 x 20 A

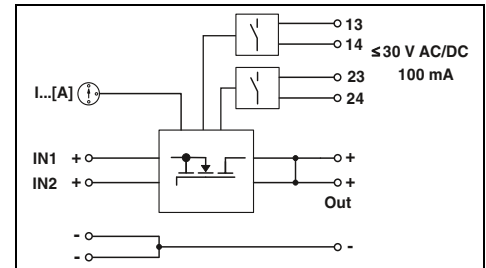

#### Technical data

##### Input data

Nominal input voltage range  
Input voltage range  
Nominal current

##### Maximum current

Transient surge protection  
Voltage drop, input/output  
Max. power dissipation (nominal load)

##### General data

Weight / Dimensions W x H x D  
Spacing when mounting

##### Connection method

Input connection data (solid / stranded / AWG)  
Output connection data (solid / stranded / AWG)  
Degree of protection / Protection class  
Ambient temperature (operation)

##### Standards/regulations

Insulation voltage: input, output/housing  
Electromagnetic compatibility  
Electrical safety  
Electronic equipm. for electrical power installations  
UL approvals

24 V DC

18 V DC ... 28 V DC  
2x 10 A (-25°C ... 60°C)  
1x 20 A (-25°C ... 60°C)  
2x 15 A (-25°C ... 40°C)  
1x 30 A (-25°C ... 40°C)

Varistor  
0.1 V ( $I_{OUT} = 20$  A)  
2 W ( $I_{OUT} = 20$  A)

0.4 kg / 32 x 130 x 125 mm  
Alignable: 5 mm horizontally, 15 mm next to active components, 50 mm vertically  
Screw connection  
0.2 - 4 mm<sup>2</sup> / 0.2 - 2.5 mm<sup>2</sup> / 14 - 12  
0.2 - 6 mm<sup>2</sup> / 0.2 - 4 mm<sup>2</sup> / 10  
IP20 / III  
-25°C ... 70°C (> 60°C derating: 2.5%/K, startup at -40°C type-tested)

500 V

Conformance with EMC Directive 2004/108/EC  
EN 60950-1/VDE 0805 (SELV)  
EN 50178/VDE 0160 (PELV)  
UL/C-UL listed UL 508, UL/C-UL Recognized UL 60950, UL ANSI/ISA-12.12.01 Class I, Division 2, Groups A, B, C, D (Hazardous Location)

#### Ordering data

##### Description

Active redundancy module

##### Type

QUINT-ORING/24DC/2X10/1X20

##### Order No.

2320173

##### Pcs. / Pkt.

1



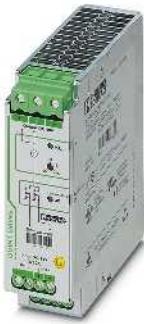

Active redundancy module, with protective coating,

24 V DC, 2 x 20 A, 1 x 40 A



Active redundancy module

24 V DC, 2 x 40 A, 1 x 80 A

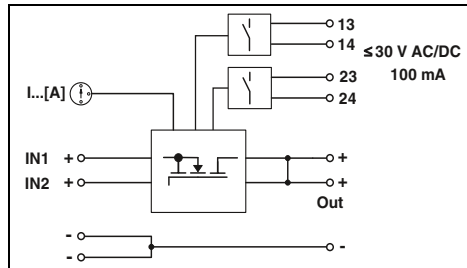
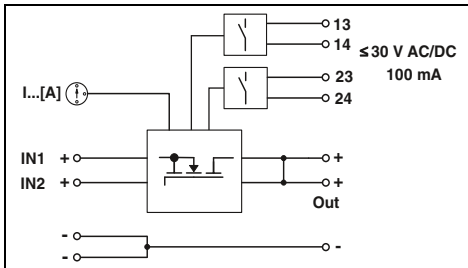

Technical data

24 V DC  
 18 V DC ... 28 V DC  
 2x 20 A (-25°C ... 60°C)  
 1x 40 A (-25°C ... 60°C)  
 2x 26 A (-25°C ... 40°C)  
 1x 52 A (-25°C ... 40°C)  
 Varistor  
 0.2 V (I<sub>OUT</sub> = 40 A)  
 8 W (I<sub>OUT</sub> = 40 A)

0.6 kg / 38 x 130 x 125 mm  
 Alignable: 5 mm horizontally, 15 mm next to active components, 50 mm vertically  
 Screw connection  
 0.2 - 6 mm<sup>2</sup> / 0.2 - 4 mm<sup>2</sup> / 10  
 0.5 - 16 mm<sup>2</sup> / 0.5 - 16 mm<sup>2</sup> / 6  
 IP20 / III  
 -25°C ... 70°C (> 60°C derating: 2.5%/K, startup at -40°C type-tested)

500 V  
 Conformance with EMC Directive 2004/108/EC  
 EN 60950-1/VDE 0805 (SELV)  
 EN 50178/VDE 0160 (PELV)  
 UL/C-UL listed UL 508, UL/C-UL Recognized UL 60950, UL ANSI/ISA-12.12.01 Class I, Division 2, Groups A, B, C, D (Hazardous Location)

Ordering data

Type	Order No.	Pcs. / Pkt.
QUINT-ORING/24DC/2X20/1X40	2320186	1

Technical data

24 V DC  
 18 V DC ... 28 V DC  
 2x 40 A (-25°C ... 60°C)  
 1x 80 A (-25°C ... 60°C)  
 2x 45 A (-25°C ... 40°C)  
 1x 90 A (-25°C ... 40°C)  
 Varistor  
 0.2 V (I<sub>OUT</sub> = 80 A)  
 16 W (I<sub>OUT</sub> = 80 A)

0.9 kg / 66 x 130 x 125 mm  
 Alignable: 5 mm horizontally, 15 mm next to active components, 50 mm vertically  
 Screw connection  
 0.5 - 16 mm<sup>2</sup> / 0.5 - 16 mm<sup>2</sup> / 6  
 0.5 - 35 mm<sup>2</sup> / 0.5 - 35 mm<sup>2</sup> / 2  
 IP20 / III  
 -25°C ... 70°C (> 60°C derating: 2.5%/K, startup at -40°C type-tested)

500 V  
 Conformance with EMC Directive 2004/108/EC  
 EN 60950-1/VDE 0805 (SELV)  
 EN 50178/VDE 0160 (PELV)  
 UL/C-UL listed UL 508, UL/C-UL Recognized UL 60950, UL ANSI/ISA-12.12.01 Class I, Division 2, Groups A, B, C, D (Hazardous Location)

Ordering data

Type	Order No.	Pcs. / Pkt.
QUINT-ORING/24DC/2X40/1X80	2902879	1

### TRIO DIODE, 12 - 24 and 48 V DC

- Permanent redundancy monitoring:  
Checking of output voltages of parallel-connected power supplies and of wiring running to the redundancy module
- Continuous redundancy right through to the load: the use of two positive output terminal blocks makes it possible to devise a redundant wiring concept that runs right through to the load.
- Flexible: nominal voltages of 12 V DC to 48 V DC



**Redundancy module,  
12 - 24 V DC, 2 x 10 A, 1 x 20 A**

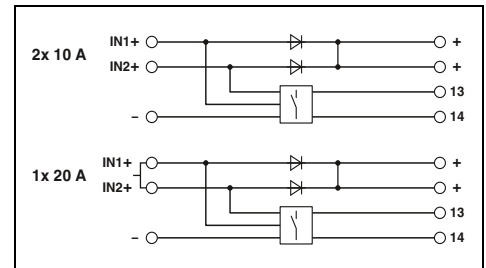

#### Technical data

<b>Input data</b>	Nominal input voltage range Input voltage range Nominal current	12 V DC ... 24 V DC 10 V DC ... 30 V DC 2x 10 A (-25°C ... 55°C) 1x 20 A (-25°C ... 55°C)
<b>Maximum current</b>	Maximum current	2x 15 A (-25°C ... 40°C) 1x 30 A (-25°C ... 40°C)
<b>Transient surge protection</b>	Transient surge protection Voltage drop, input/output Max. power dissipation (nominal load)	Varistor 0.5 V 7 W (I <sub>OUT</sub> = 10 A)
<b>General data</b>	Weight / Dimensions W x H x D Spacing when mounting Connection method Input connection data (solid / stranded / AWG) Output connection data (solid / stranded / AWG) Degree of protection / Protection class Ambient temperature (operation)	0.37 kg / 32 x 130 x 115 mm Alignable: horizontally 0 mm, vertically 50 mm Screw connection 0.2 - 2.5 mm <sup>2</sup> / 0.2 - 2.5 mm <sup>2</sup> / 24 - 14 0.5 - 6 mm <sup>2</sup> / 0.5 - 4 mm <sup>2</sup> / 20 - 10 IP20 / III -25°C ... 70°C (> 55°C derating: 2.5%/K)
<b>Standards/regulations</b>	Insulation voltage: input, output/housing Electromagnetic compatibility Electrical safety, safety transformer Electronic equipm. for electrical power installations UL approvals	500 V Conformance with EMC Directive 2004/108/EC EN 60950-1/VDE 0805 (SELV) EN 50178/VDE 0160 (PELV) UL/C-UL listed UL 508, UL/C-UL Recognized UL 60950

#### Ordering data

Description	Type	Order No.	Pcs. / Pkt.
<b>Redundancy module</b>	TRIO-DIODE/12-24DC/2X10/1X20	<b>2866514</b>	1



**Redundancy module**  
48 V DC, 2x 10 A, 1x 20 A

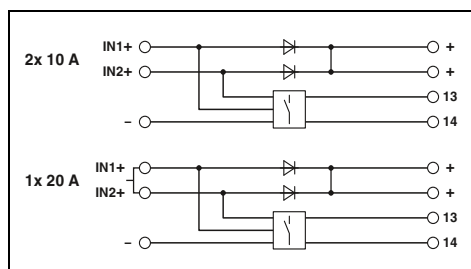

#### Technical data

48 V DC  
30 V DC ... 56 V DC  
2x 10 A (-25°C ... 55°C)  
1x 20 A (-25°C ... 55°C)  
2x 15 A (-25°C ... 40°C)  
1x 30 A (-25°C ... 40°C)  
Varistor  
approx. 0.65 V  
14 W ( $I_{OUT} = 20$  A)

0.37 kg / 32 x 130 x 115 mm  
Alignable: horizontally 0 mm, vertically 50 mm  
Screw connection  
0.2 - 2.5 mm<sup>2</sup> / 0.2 - 2.5 mm<sup>2</sup> / 24 - 14  
0.5 - 6 mm<sup>2</sup> / 0.5 - 4 mm<sup>2</sup> / 20 - 10  
IP20 / III  
-25°C ... 70°C (> 55° C derating: 2.5%/K)

500 V  
Conformance with EMC Directive 2004/108/EC  
EN 60950-1/VDE 0805 (SELV)  
EN 50178/VDE 0160 (PELV)  
UL/C-UL listed UL 508, UL/C-UL Recognized UL 60950

#### Ordering data

Type	Order No.	Pcs. / Pkt.
TRIO-DIODE/48DC/2X10/1X20	<a href="#">2866527</a>	1

## Redundancy modules

### QUINT DIODE, STEP DIODE, and UNO DIODE diode modules

#### QUINT DIODE, 12 - 24 V and 48 V DC

- Robust design for currents of up to 60 A
- Continuous redundancy right through to the load: the use of two positive output terminal blocks makes it possible to devise a redundant wiring concept that runs right through to the load.
- Flexible: nominal voltages of 12 V DC to 48 V DC
- Complies with standard EN 60079-15 and may be installed in a potentially explosive area

#### STEP DIODE

- Space-saving: overall width of just 18 mm
- Continuous redundancy right through to the load: the use of two positive output terminal blocks makes it possible to devise a redundant wiring concept that runs right through to the load.
- Flexible: nominal voltages of 5 V DC to 24 V DC

#### UNO DIODE

- Space-saving: overall width of just 22.5 mm
- Continuous redundancy right through to the load: the use of two positive output terminal blocks makes it possible to devise a redundant wiring concept that runs right through to the load.
- Flexible: nominal voltages of 5 V DC to 24 V DC



Diode module, with protective coating,  
12 - 24 V DC, 2 x 20 A, 1 x 40 A

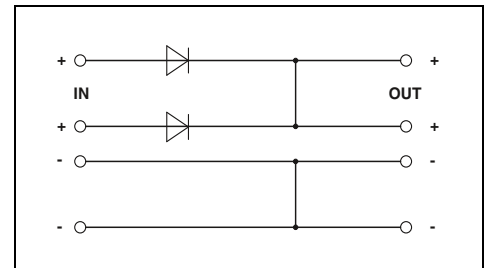

<b>Input data</b>	
Nominal input voltage range	12 V DC ... 24 V DC
Input voltage range	10 V DC ... 30 V DC
Nominal current	2x 20 A (-25°C ... 60°C) 1x 40 A (-25°C ... 60°C)
Maximum current	2x 30 A (-25°C ... 40°C) 1x 60 A (-25°C ... 40°C)
<b>General data</b>	
Transient surge protection	Varistor
Voltage drop, input/output	0.5 V
Max. power dissipation (nominal load)	10 W (I <sub>OUT</sub> = 20 A)
<b>General data</b>	
Weight / Dimensions W x H x D	0.75 kg / 50 x 130 x 125 mm
Spacing when mounting	Alignable: 5 mm horizontally, 15 mm next to active components, 50 mm vertically
Connection method	Screw connection
Input connection data (solid / stranded / AWG)	0.2 - 6 mm <sup>2</sup> / 0.2 - 4 mm <sup>2</sup> / 12 - 10
Output connection data (solid / stranded / AWG)	0.5 - 16 mm <sup>2</sup> / 0.5 - 16 mm <sup>2</sup> / 10 - 6
Degree of protection / Protection class	IP20 / III
Ambient temperature (operation)	-40°C ... 70°C (> 60°C derating: 2.5%/K)
<b>Standards/regulations</b>	
Insulation voltage: input, output/housing	500 V
Electromagnetic compatibility	Conformance with EMC Directive 2004/108/EC
Electrical safety, safety transformer	EN 60950-1/VDE 0805 (SELV)
Electronic equipm. for electrical power installations	EN 50178/VDE 0160 (PELV)
UL approvals	UL/C-UL listed UL 508, UL/C-UL Recognized UL 60950, UL ANSI/ISA-12.12.01 Class I, Division 2, Groups A, B, C, D (Hazardous Location)

#### Technical data

<b>Technical data</b>	
Nominal input voltage range	12 V DC ... 24 V DC
Input voltage range	10 V DC ... 30 V DC
Nominal current	2x 20 A (-25°C ... 60°C) 1x 40 A (-25°C ... 60°C)
Maximum current	2x 30 A (-25°C ... 40°C) 1x 60 A (-25°C ... 40°C)
<b>General data</b>	
Transient surge protection	Varistor
Voltage drop, input/output	0.5 V
Max. power dissipation (nominal load)	10 W (I <sub>OUT</sub> = 20 A)
<b>General data</b>	
Weight / Dimensions W x H x D	0.75 kg / 50 x 130 x 125 mm
Spacing when mounting	Alignable: 5 mm horizontally, 15 mm next to active components, 50 mm vertically
Connection method	Screw connection
Input connection data (solid / stranded / AWG)	0.2 - 6 mm <sup>2</sup> / 0.2 - 4 mm <sup>2</sup> / 12 - 10
Output connection data (solid / stranded / AWG)	0.5 - 16 mm <sup>2</sup> / 0.5 - 16 mm <sup>2</sup> / 10 - 6
Degree of protection / Protection class	IP20 / III
Ambient temperature (operation)	-40°C ... 70°C (> 60°C derating: 2.5%/K)
<b>Standards/regulations</b>	
Insulation voltage: input, output/housing	500 V
Electromagnetic compatibility	Conformance with EMC Directive 2004/108/EC
Electrical safety, safety transformer	EN 60950-1/VDE 0805 (SELV)
Electronic equipm. for electrical power installations	EN 50178/VDE 0160 (PELV)
UL approvals	UL/C-UL listed UL 508, UL/C-UL Recognized UL 60950, UL ANSI/ISA-12.12.01 Class I, Division 2, Groups A, B, C, D (Hazardous Location)

Description	Diode module
-------------	--------------

#### Ordering data

Type	Order No.	Pcs. / Pkt.
QUINT-DIODE/12-24DC/2X20/1X40	2320157	1

new



Diode module, with protective coating,  
48 V DC, 2 x 20 A, 1 x 40 A



Diode module  
5 - 24 V DC, 2 x 5 A, 1 x 10 A



Diode module,  
5 ... 24 V DC, 2 x 10 A, 1 x 20 A

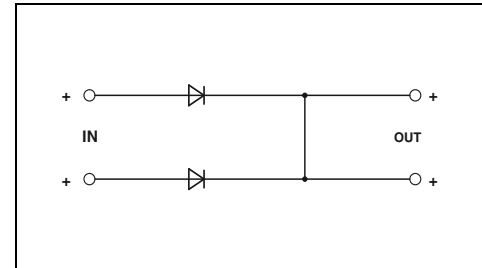
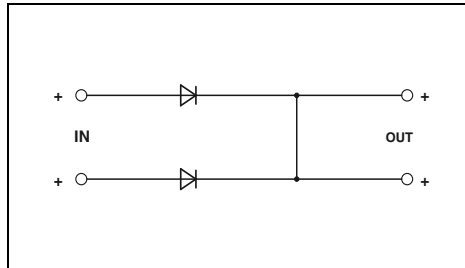
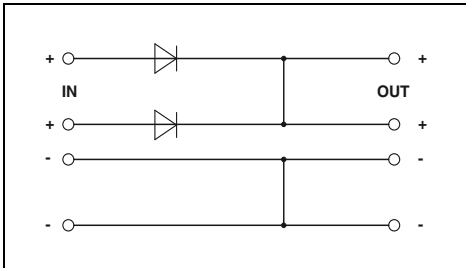

Technical data

48 V DC  
30 V DC ... 56 V DC  
2x 20 A (-25°C ... 60°C)  
1x 40 A (-25°C ... 60°C)  
2x 30 A (-25°C ... 40°C)  
1x 60 A (-25°C ... 40°C)  
Varistor  
0.7 V  
14 W (I<sub>OUT</sub> = 20 A)

0.75 kg / 50 x 130 x 125 mm  
Alignable: 5 mm horizontally, 15 mm next to active components, 50 mm vertically  
Screw connection  
0.2 - 6 mm<sup>2</sup> / 0.2 - 4 mm<sup>2</sup> / 12 - 10  
0.5 - 16 mm<sup>2</sup> / 0.5 - 16 mm<sup>2</sup> / 10 - 6  
IP20 / III  
-40°C ... 70°C (> 60°C derating: 2.5%/K)

500 V  
Conformance with EMC Directive 2004/108/EC  
EN 60950-1/VDE 0805 (SELV)  
EN 50178/VDE 0160 (PELV)  
UL/C-UL listed UL 508, UL/C-UL Recognized UL 60950,  
UL ANSI/ISA-12.12.01 Class I, Division 2, Groups A, B, C, D (Hazardous Location)

Technical data

5 V DC ... 24 V DC  
4.5 V DC ... 30 V DC  
2x 5 A (-25°C ... 55°C)  
1x 10 A (-25°C ... 55°C)  
-  
-  
Transil diode  
0.5 V  
2.5 W (I<sub>OUT</sub> = 5 A)

0.1 kg / 18 x 90 x 61 mm  
Alignable: 0 mm horizontally, 30 mm vertically  
Screw connection  
0.2 - 2.5 mm<sup>2</sup> / 0.2 - 2.5 mm<sup>2</sup> / 24 - 12  
0.2 - 2.5 mm<sup>2</sup> / 0.2 - 2.5 mm<sup>2</sup> / 24 - 12  
IP20 / III  
-25°C ... 70°C (> 55°C derating: 2.5%/K)

500 V  
Conformance with EMC Directive 2004/108/EC  
IEC 60950-1/VDE 0805 (SELV)  
EN 50178/VDE 0160 (PELV)  
UL/C-UL listed UL 508, UL/C-UL Recognized UL 60950

Technical data

5 V DC ... 24 V DC  
4.5 V DC ... 30 V DC  
2x 10 A (-25°C ... 55°C)  
1x 20 A (-25°C ... 55°C)  
-  
-  
Varistor  
0.5 V  
5 W (I<sub>OUT</sub> = 10 A)

0.2 kg / 22.5 x 90 x 84 mm  
Alignable: 0 mm horizontally, 30 mm vertically  
Screw connection  
0.2 - 2.5 mm<sup>2</sup> / 0.2 - 2.5 mm<sup>2</sup> / 24 - 14  
0.2 - 2.5 mm<sup>2</sup> / 0.2 - 2.5 mm<sup>2</sup> / 24 - 14  
IP20 / III  
-25°C ... 70°C (> 55°C derating: 2.5%/K)

500 V  
Conformance with EMC Directive 2004/108/EC  
IEC 60950-1/VDE 0805 (SELV)  
EN 50178/VDE 0160 (PELV)  
UL/C-UL listed UL 508, UL/C-UL Recognized UL 60950

Ordering data

Type	Order No.	Pcs. / Pkt.
QUINT-DIODE/48DC/2X20/1X40	2320160	1

Ordering data

Type	Order No.	Pcs. / Pkt.
STEP-DIODE/5-24DC/2X5/1X10	2868606	1

Ordering data

Type	Order No.	Pcs. / Pkt.
UNO-DIODE/5-24DC/2X10/1X20	2905489	1

# Power supplies and UPS

## Power supply unit accessories

### Mounting on S7-300 rail

To supply a SIMATIC® S7-300 control unit, QUINT POWER 2.5 A, 5 A, and 10 A are mounted on the S7 rail using a QUINT-PS-ADAPTER-S7.

No further accessories are required for fastening.



Dimensions W x H x D  
Material

Technical data
74 / 130 / 11 mm Aluminum

Technical data
104 / 130 / 11 mm Aluminum

Description

**Adapter for S7-300 rail mounting, for:**  
 QUINT-PS/1AC/24DC/3.5  
 QUINT-PS/1AC/24DC/5  
 QUINT-PS/3AC/24DC/5  
**Adapter for S7-300 rail mounting, for:**  
 QUINT-PS/1AC/24DC/10  
 QUINT-PS/3AC/24DC/10  
 QUINT-PS/3AC/24DC/20

Ordering data		
Type	Order No.	Pcs. / Pkt.
QUINT-PS-ADAPTERS7/1	2938196	1

Ordering data		
Type	Order No.	Pcs. / Pkt.
QUINT-PS-ADAPTERS7/2	2938206	1

### Fan and potential distributor

With the standard power supply mounting position, the temperature range increases by 10 K (max. ambient temperature of 70°C), when the mounting position is rotated, position-dependent derating no longer applies.

– assembly without tools

#### Potential distributor

Further modules can be found in Catalog 7, interface technology and switching devices

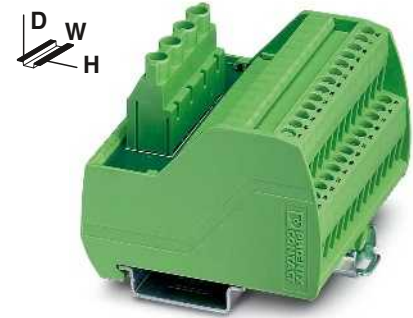

With screw connection and 2 potential levels

Dimensions W x H x D

Technical data
41 / 27 / 42.2 mm

Technical data
50 / 65.5 / 50 mm

Description

Fan for QUINT POWER SFB, 24 V DC

**VARIOFACE module**, with two busbars (P1, P2) for potential distribution, per potential:  
 2 power terminals/8 distributor terminal blocks  
 2 power terminals/12 distributor terminal blocks  
 2 power terminals/16 distributor terminal blocks  
 2 power terminals/24 distributor terminal blocks

Ordering data		
Type	Order No.	Pcs. / Pkt.
QUINT-PS/FAN/4	2320076	1

Ordering data		
Type	Order No.	Pcs. / Pkt.
VIP-2/SC/PDM-2/16	2315256	1
VIP-2/SC/PDM-2/24	2315269	1
VIP-2/SC/PDM-2/32	2315272	1
VIP-2/SC/PDM-2/48	2903717	1

### Universal wall adapter

Adapter for mounting on even surfaces

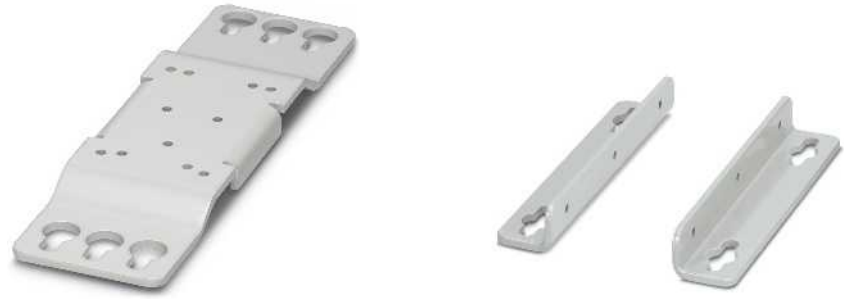

Dimensions W x H x D  
Material

Technical data		
52 / 182 / 9 mm		
Steel, powder-coated		

Technical data		
25 / 130 / 17 mm		
Steel, powder-coated		

Description

**Universal wall adapter**, for mounting the TRIO-PS (from 10 A), QUINT-PS, QUINT-DC-UPS, and QUINT-BUFFER power supply units directly on the wall

**Universal wall adapter**, for mounting the QUINT-PS/1AC/24DC/40 and QUINT-UPS/1AC/1AC/500VA power supply units directly on the wall

Ordering data		
Type	Order No.	Pcs. / Pkt.
UWA 182/52	2938235	1

Ordering data		
Type	Order No.	Pcs. / Pkt.
UWA 130	2901664	1

### Plug-in thermomagnetic circuit breakers

- Device circuit breakers for protecting against overcurrents and short circuits
- SFB characteristic curve enables longer cables and release times < 10 ms
- Maximum ease of maintenance thanks to the two-piece design
- Further circuit breakers can be found from page 253 onwards.



Plug-in, SFB characteristic curve

Dimensions W / H / D  
Degree of protection

Technical data		
12.3 mm / 90 mm / 77.3 mm		
IP30 (actuation area)		

Description	Nominal current
<b>Thermomagnetic circuit breaker</b> , plug-in, 1-pos., signal contact 1 PDT	0.5 A
	1 A
	2 A
	3 A
	4 A
	5 A
	6 A

Ordering data		
Type	Order No.	Pcs. / Pkt.
CB TM1 0.5A SFB P	2800835	1
CB TM1 1A SFB P	2800836	1
CB TM1 2A SFB P	2800837	1
CB TM1 3A SFB P	2800838	1
CB TM1 4A SFB P	2800839	1
CB TM1 5A SFB P	2800840	1
CB TM1 6A SFB P	2800841	1

Accessories		
<b>Base element</b> , for accommodating CB TM.../CB E... device circuit breakers		
With push-in connection technology	2800929	10
With screw connection technology	2801305	10



### The intelligent UPS system ensures superior system availability

Uninterruptible power supply (UPS) units continue to deliver power even if the supply network goes down. An uninterruptible solution consists of the three function units shown:

- Power supply
- UPS module
- Power storage

### QUINT UPS

IQ technology is the key to an intelligent power supply solution. The uninterruptible power supply unit monitors and optimizes the power storage. Avoid interruptions when working with the intelligent UPS for non-stop power.

- You know the state of charge and remaining runtime of your power storage
- You are warned about failures at an early stage and have time to prevent them
- You can maximize the service life of the power storage
- You can transfer all relevant information to your computer and higher-level controllers

### Practical example

An industrial PC must be continuously supplied with 24 V DC.

### Previous solution:

The UPS with 3.4 Ah power storage buffers 24 V DC/5 A for 20 minutes under optimum conditions.

Can the power storage actually bridge this time?

State of charge, performance, and remaining runtime of the power storage are unknown.

### Solution with QUINT UPS:

The intelligent UPS determines all relevant power storage states. This ensures the crucial transparency required to guarantee the stability of the supply and optimum use of the power storage at all times.

The intelligent battery management detects the current state of charge of the connected power storage and uses this to calculate the remaining runtime.

The QUINT UPS also indicates whether the buffer time is actually 20 minutes. As soon as an adjustable threshold value is reached, a warning message is sent via the floating relay contact, the software or directly to higher-level controllers. The IPC continues working for as long as possible and is shut down before the battery voltage runs out.

### Space-saving versions

To save space in the control cabinet or to retrofit existing systems easily, UPS versions with integrated power storage or integrated power supply are recommended.

### Selection guide

Find the right UPS for your application based on the buffer time and load current. Please refer to the color selection tables on pages:

- 218
- 232

**i** Your web code: #0154



Uninterruptible power supply units for the control cabinet



**IQ technology**

The IQ technology is intuitive and provides you with information as soon as it is required.

- Intelligent battery management with SOC (state of charge), detects the current state of charge and the remaining runtime, and SOH (state of health), determines the remaining life expectancy of the power storage and warns of failure at an early stage
- Intelligent battery control
- Intelligent charging



**Signaling and configuration**

The UPS-CONF configuration and management software allows you to monitor and configure your UPS system. The software can be downloaded free of charge at: [phoenixcontact.net/products](http://phoenixcontact.net/products).

- Flexible adaptation of QUINT UPS behavior to individual requirements
- Monitoring and data recorder



**Communication**

The data cables allow you to integrate the UPS module into your application. You can therefore benefit from all the advantages of IQ technology and be kept informed of the state of your UPS solution. The information provided by QUINT UPS can, for example, be forwarded to higher-level controllers via Ethernet or be implemented directly in control solutions from Phoenix Contact.



**Modular solution**

1. Choose your power supply unit, e.g., QUINT POWER
2. Choose your UPS module QUINT UPS module
3. Choose your power storage:
  - UPS-CAP for maximum service life
  - UPS-BAT/LI-ION for long service life with long buffer times
  - UPS-BAT/VRLA and VRLA-WTR for maximum buffer times



**UPS with integrated power storage**

Particularly space saving and easy to retrofit, the UPS module and power storage are combined in the same housing.

- QUINT UPS: power storage with lead AGM technology
- STEP UPS: LiPo-based power storage
- UNO UPS: power storage with lead AGM technology
- QUINT BUFFER buffer module: capacitor-based power storage



**UPS with integrated power supply unit**

The UPS module and power supply unit in a single housing is a space-saving solution. Only one power storage is required to complete the UPS system.

- MINI UPS: for 24 or 12 V DC
- TRIO UPS: for 24 DC

# Power supplies and UPS

## Uninterruptible power supply units for the control cabinet

### Selecting the power storage for QUINT UPS

You can always find the ideal solution for superior system availability with the new modular system for uninterruptible power supply units. The various storage media feature a wide range of different properties: long service life or very long buffer time, no maintenance or use at extreme ambient temperatures. Whatever your requirements, we offer the ideal power storage.

#### Your advantages

- Fast installation
- Automatic detection of the power storage by QUINT UPS
  - Tool-free replacement during operation

#### Maximum availability

- Constant communication with QUINT UPS for continuous monitoring and intelligent management

#### Extremely long service life

- Optimum charging characteristic according to the technology and ambient conditions

Type	Buffer time (typical)	Temperature	Service life at 20°C	Service life at 50°C	Charging cycles at 20°C	Weight (standardized)
UPS-CAP...	< 5 min.	-40 to 60°C	> 20 years	8 years	> 500,000	0.4 kg
UPS-BAT/LI-ION...	> 40 min.	-20 to 58°C	15 years	2 years	7000	0.45 kg
UPS-BAT/VRLA-WTR...	> 5 h	-25 to 60°C	12 years	1.5 years	300	1.3 kg
UPS-BAT/VRLA...	> 8 h	0 to 40°C	6 to 9 years	1 year	250	1 kg



**UPS-BAT/VRLA... (Valve Regulated Lead Acid)**

- Maximum buffer times
- Lead AGM (Absorbed Glass Mat) technology



**UPS-BAT/VRLA-WTR... (Valve Regulated Lead Acid/ Wide Temperature Range)**

- Maximum buffer times at extreme temperatures
- Pure lead AGM (Absorbed Glass Mat) technology



**UPS-BAT/LI-ION...**

- Long service life with long buffer times
- Lithium-ion technology



**UPS-CAP (Capacitor)**

- Maximum service life
- Maintenance-free double-layer capacitors

**BATTERY CHARGE 100%** Immediate availability: All power storage devices leave our warehouse fully charged

Selection of power storage devices with capacitors, lithium ion, and pure lead AGM technology

Buffer times for DC UPS modules

Select your UPS-BAT and UPS-CAP for 24 V DC applications here.

Example: 20 A needs to be buffered for 6 minutes.

Solution:  
UPS-BAT/LI-ION/24DC/120WH

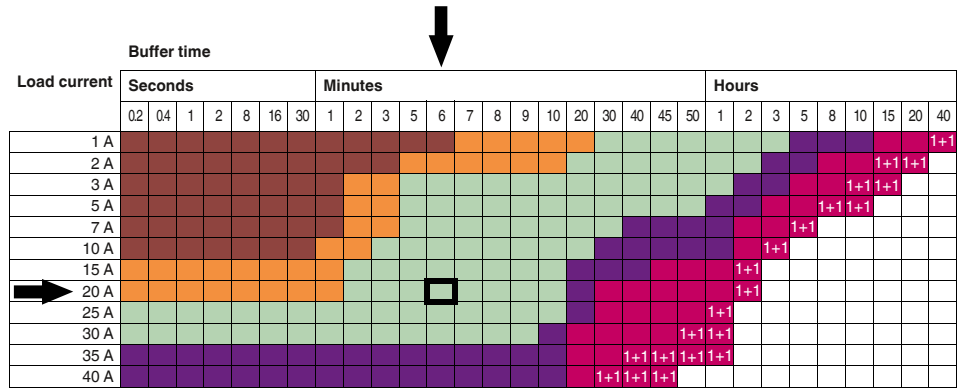

Buffer times for AC UPS modules

Select your UPS-BAT and UPS-CAP for 120 V AC/230 V AC applications here.

Example: 125 W needs to be buffered for one hour.

Solution:  
UPS-BAT/VRLA-WTR/24DC/13AH

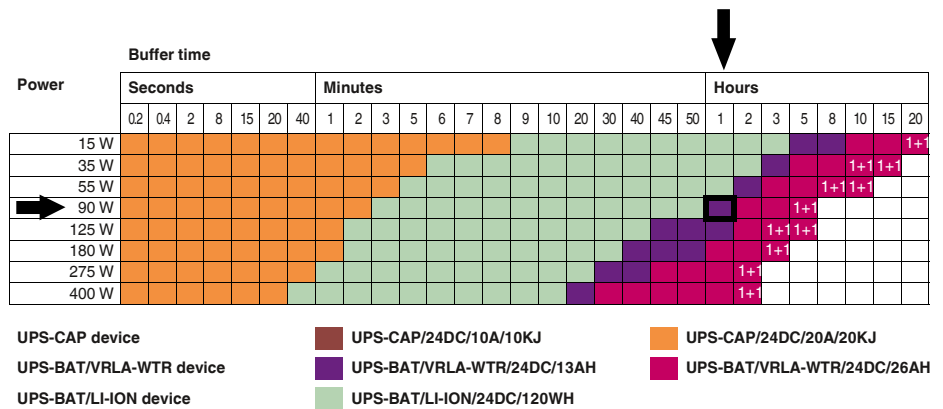

Selection of power storage devices with lead AGM technology

Buffer times for DC UPS modules

Select your UPS-BAT for 24 V DC applications here.

Example: 20 A needs to be buffered for 10 minutes.

Solution: UPS-BAT/VRLA/24DC/7.2AH

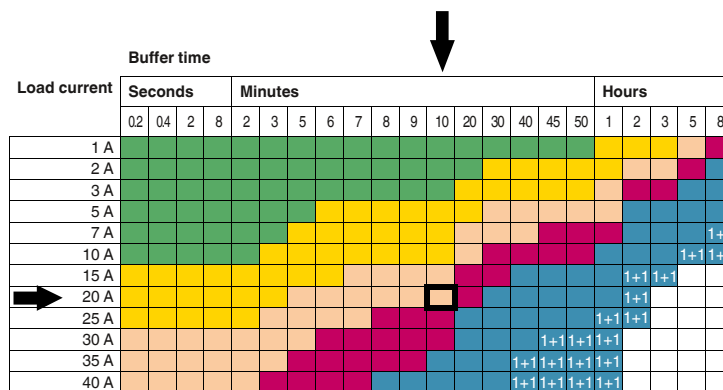

Buffer times for AC UPS modules

Select your UPS-BAT for 120 V AC/230 V AC applications here.

Example: 125 W needs to be buffered for one hour.

Solution: UPS-BAT/VRLA/24DC/12AH

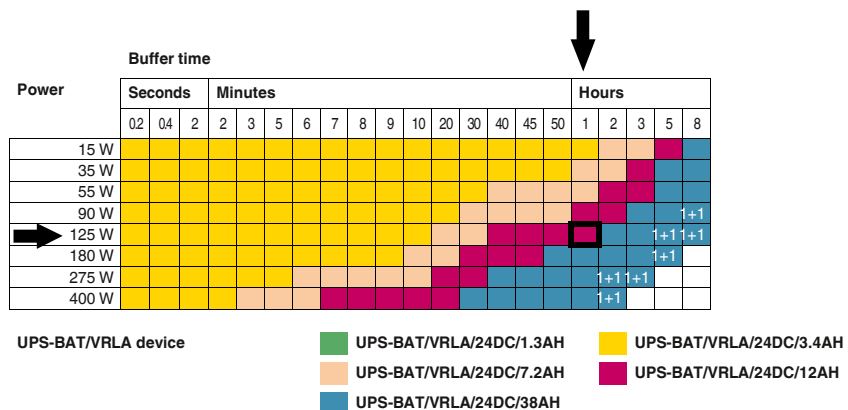

1+1 ... Two rechargeable battery modules of the same capacity are required in this case.  
The data is based on an ambient temperature of 20°C.

# Power supplies and UPS

## Uninterruptible power supply units for the control cabinet

### QUINT UPS for DC applications

The UPS module for 24 V DC with output currents ranging from 5 to 40 A allows you to create a custom solution combining power supply unit, UPS module, and power storage.

Optimum use of the buffer time and preventive monitoring of the power storage:

- Detects the current state of charge of the power storage and calculates the remaining runtime
- Calculates the current life expectancy of the power storage

Substantial power reserve:

- For mains and battery operation
- POWER BOOST static power reserve
- Dynamic power reserve with SFB (selective fuse breaking) technology

Fast battery charging:

- Adaptive current management charges the power storage twice as fast as before, while simultaneously providing sufficient energy for the loads.

Extensive signaling and parameterization:

- Floating relay contacts
- Data port
- Parameterization with memory module

#### Notes:

The buffer time associated with your solution is dependent on the load current. Exact details for each uninterruptible power supply can be found on page 233.



Uninterruptible power supply,  
24 V DC / 24 V DC, 5 A

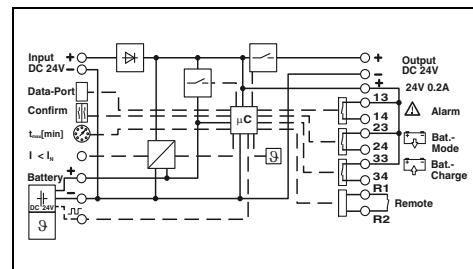

#### Technical data

<b>Input data</b>	24 V DC 18 V DC ... 30 V DC 9.4 A (maximum, mains operation)
<b>Output data (mains operation)</b>	24 V DC 18 V DC ... 30 V DC > 98% (mains operation, with charged power storage)
<b>Output current with convection cooling</b>	5 A (-25°C ... 60°C) 30 A (-25°C ... 60°C) 7.5 A (-25°C ... 40°C)
<b>Output data (battery operation)</b>	24 V DC 19.2 V DC ... 27.6 V DC ( $U_{OUT} = U_{BAT} - 0.5 V DC$ )
<b>Output current with convection cooling</b>	32.5 A (-25°C ... 60°C) 7.5 A (-25°C ... 40°C)
<b>Power storage</b>	24 V DC 24 V DC ... 29 V DC (temperature compensated) 0.8 Ah ... 140 Ah 0.2 A ... 1.36 A
<b>Signaling</b>	LED, relay contact, interface/software IFS (Interface system data port)
<b>General data</b>	0.5 kg / 35 x 130 x 125 mm Plug-in screw connection 0.2 - 2.5 mm <sup>2</sup> / 0.2 - 2.5 mm <sup>2</sup> / 20 - 12 0.2 - 2.5 mm <sup>2</sup> / 0.2 - 2.5 mm <sup>2</sup> / 20 - 12 0.2 - 2.5 mm <sup>2</sup> / 0.2 - 2.5 mm <sup>2</sup> / 24 - 12 IP20 / III -25°C ... 70°C -40°C ... 85°C 60°C ... 70°C (2.5%/K) ≤ 95% (25°C, non-condensing)
<b>Standards/regulations</b>	UL Listed UL 508, UL/C-UL Recognized UL 60950, UL ANSI/ISA-12.12.01 Class I, Division 2, Groups A, B, C, D (Hazardous Location)

#### Ordering data

Description	Type	Order No.	Pcs. / Pkt.
Power supply, uninterruptible	QUINT-UPS/ 24DC/ 24DC/ 5	2320212	1

Uninterruptible power supply units for the control cabinet

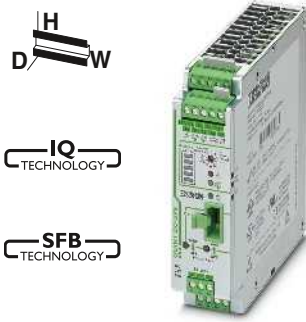

H  
D W

IO  
TECHNOLOGY

SFB  
TECHNOLOGY

Uninterruptible power supply,  
24 V DC / 24 V DC, 10 A



H  
D W

IO  
TECHNOLOGY

SFB  
TECHNOLOGY

Uninterruptible power supply,  
24 V DC / 24 V DC, 20 A



H  
D W

IO  
TECHNOLOGY

SFB  
TECHNOLOGY

Uninterruptible power supply,  
24 V DC / 24 V DC, 40 A

UL  
UL  
Ex:

UL  
UL  
Ex:

UL  
UL  
Ex:

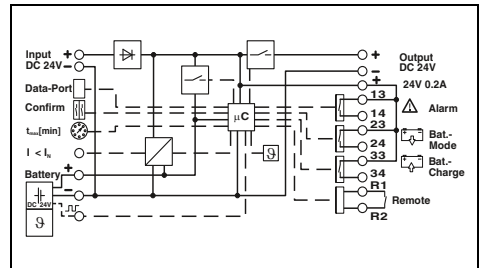
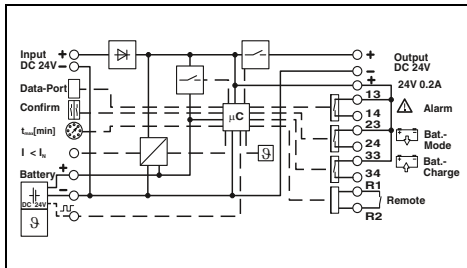
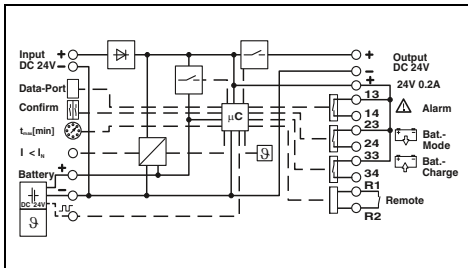

Technical data

Technical data

Technical data

24 V DC  
18 V DC ... 30 V DC  
19 A (maximum, mains operation)

24 V DC  
18 V DC ... 30 V DC  
32.9 A (maximum, mains operation)

24 V DC  
18 V DC ... 30 V DC  
51.9 A (maximum, mains operation)

24 V DC  
18 V DC ... 30 V DC  
> 98% (mains operation, with charged power storage)

24 V DC  
18 V DC ... 30 V DC  
> 98% (mains operation, with charged power storage)

24 V DC  
18 V DC ... 30 V DC  
> 99% (mains operation, with charged power storage)

10 A (-25°C ... 60°C)  
60 A (-25°C ... 60°C)  
15 A (-25°C ... 40°C)

20 A (-25°C ... 60°C)  
120 A (-25°C ... 60°C)  
26 A (-25°C ... 40°C)

40 A (-25°C ... 50°C)  
215 A (-25°C ... 60°C)  
45 A (-25°C ... 40°C)

24 V DC  
19.2 V DC ... 27.6 V DC ( $U_{OUT} = U_{BAT} - 0.5 \text{ V DC}$ )

24 V DC  
19.2 V DC ... 27.6 V DC ( $U_{OUT} = U_{BAT} - 0.5 \text{ V DC}$ )

24 V DC  
19.2 V DC ... 27.6 V DC ( $U_{OUT} = U_{BAT} - 0.5 \text{ V DC}$ )

65 A (-25°C ... 60°C)  
15 A (-25°C ... 40°C)

120 A (-25°C ... 60°C)  
27 A (-25°C ... 40°C)

215 A (-25°C ... 60°C)  
45 A (-25°C ... 40°C)

24 V DC  
24 V DC ... 29 V DC (temperature compensated)  
1.3 Ah ... 140 Ah  
0.2 A ... 2.88 A

24 V DC  
24 V DC ... 29 V DC (temperature compensated)  
3 Ah ... 200 Ah  
0.2 A ... 5 A

24 V DC  
24 V DC ... 29 V DC (temperature compensated)  
7 Ah ... 200 Ah  
0.2 A ... 5 A

LED, relay contact, interface/software  
IFS (Interface system data port)

LED, relay contact, interface/software  
IFS (Interface system data port)

LED, relay contact, interface/software  
IFS (Interface system data port)

0.5 kg / 35 x 130 x 125 mm  
Plug-in screw connection  
0.2 - 2.5 mm<sup>2</sup> / 0.2 - 2.5 mm<sup>2</sup> / 16 - 12  
0.2 - 2.5 mm<sup>2</sup> / 0.2 - 2.5 mm<sup>2</sup> / 16 - 12  
0.2 - 2.5 mm<sup>2</sup> / 0.2 - 2.5 mm<sup>2</sup> / 24 - 12  
IP20 / III  
-25°C ... 70°C  
-40°C ... 85°C  
60°C ... 70°C (2.5%/K)  
≥ 95% (25°C, non-condensing)

0.6 kg / 40 x 130 x 125 mm  
Screw connection  
0.2 - 6 mm<sup>2</sup> / 0.2 - 4 mm<sup>2</sup> / 12 - 10  
0.2 - 6 mm<sup>2</sup> / 0.2 - 4 mm<sup>2</sup> / 12 - 10  
0.2 - 4 mm<sup>2</sup> / 0.2 - 2.5 mm<sup>2</sup> / 24 - 12  
IP20 / III  
-25°C ... 70°C  
-40°C ... 85°C  
60°C ... 70°C (2.5%/K)  
≤ 95% (25°C, non-condensing)

0.7 kg / 47 x 130 x 125 mm  
Screw connection  
0.5 - 16 mm<sup>2</sup> / 0.5 - 16 mm<sup>2</sup> / 8 - 6  
0.5 - 16 mm<sup>2</sup> / 0.5 - 16 mm<sup>2</sup> / 8 - 6  
0.2 - 4 mm<sup>2</sup> / 0.2 - 2.5 mm<sup>2</sup> / 24 - 12  
IP20 / III  
-25°C ... 70°C  
-40°C ... 85°C  
60°C ... 70°C (2.5%/K)  
≤ 95% (25°C, non-condensing)

UL Listed UL 508, UL/C-UL Recognized UL 60950,  
UL ANSI/ISA-12.12.01 Class I, Division 2, Groups A, B, C, D  
(Hazardous Location)

UL Listed UL 508, UL/C-UL Recognized UL 60950,  
UL ANSI/ISA-12.12.01 Class I, Division 2, Groups A, B, C, D  
(Hazardous Location)

UL Listed UL 508, UL/C-UL Recognized UL 60950,  
UL ANSI/ISA-12.12.01 Class I, Division 2, Groups A, B, C, D  
(Hazardous Location)

Ordering data

Ordering data

Ordering data

Type	Order No.	Pcs. / Pkt.
QUINT-UPS/ 24DC/ 24DC/10	2320225	1

Type	Order No.	Pcs. / Pkt.
QUINT-UPS/ 24DC/ 24DC/20	2320238	1

Type	Order No.	Pcs. / Pkt.
QUINT-UPS/ 24DC/ 24DC/40	2320241	1

# Power supplies and UPS

## Uninterruptible power supply units for the control cabinet

### QUINT UPS for DC applications with dual output voltage

The UPS module for two output voltages, 12 and 24 V DC, allows you to create a custom solution combining power supply unit, UPS module, and power storage.

- Flexible and space saving thanks to the two output voltages in one unit

Optimum use of the buffer time and preventive monitoring of the power storage:

- Detects the current state of charge of the power storage and calculates the remaining runtime
- Calculates the current life expectancy of the power storage

Substantial power reserve:

- For mains and battery operation
- POWER BOOST static power reserve
- Dynamic power reserve with SFB (selective fuse breaking) technology

Fast battery charging:

- Adaptive current management charges the power storage twice as fast as before, while simultaneously providing sufficient energy for the loads.

Extensive signaling and parameterization:

- Floating relay contacts
- Data port
- Parameterization with memory module

#### Notes:

The buffer time associated with your solution is dependent on the load current. Exact details for each uninterruptible power supply can be found on page 233.



Uninterruptible power supply, 24 V DC/12 V DC, 5 A and 24 V DC, 10 A

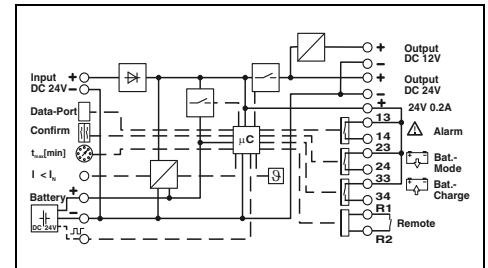

#### Technical data

Input data	24 V DC
Input voltage	18 V DC ... 30 V DC
Input voltage range	16 A
Max. current consumption	24 V DC
Output data (mains operation)	12 V DC
Nominal output voltage	12 V DC
Output voltage range	18 V DC ... 30 V DC ( $U_{OUT} = U_{IN} - 0.5 \text{ V DC}$ )
Efficiency (typ.)	> 93% (mains operation, with charged power storage)
Output current with convection cooling ( $P_{max} = P_{12 \text{ V}} + P_{24 \text{ V}} = 360 \text{ W}$ )	> 98% (mains operation, with charged power storage)
- Nominal output current $I_N$ (continual)	5 A (-25°C ... 60°C)
- SFB technology (15 ms)	10 A (-25°C ... 60°C)
- POWER BOOST $I_{BOOST}$ (continual)	7.5 A (-25°C ... 40°C)
Output data (battery operation)	12 V DC
Nominal output voltage	12 V DC
Output voltage range	19.2 V DC ... 27.6 V DC ( $U_{OUT} = U_{BAT} - 0.5 \text{ V DC}$ )
Output current with convection cooling ( $P_{max} = P_{12 \text{ V}} + P_{24 \text{ V}} = 360 \text{ W}$ )	5 A (-25°C ... 60°C)
- Nominal output current $I_N$ (continual)	10 A (-25°C ... 60°C)
- SFB technology (15 ms)	65 A (-25°C ... 60°C)
- POWER BOOST $I_{BOOST}$ (continual)	7.5 A (-25°C ... 60°C)
Power storage	24 V DC
Nominal voltage $U_N$	24 V DC ... 29 V DC (temperature compensated)
End-of-charge voltage	1.3 Ah ... 140 Ah
Nominal capacity range	2.88 A
Max. charging current	LED, relay contact, interface/software
Signaling	IFS (Interface system data port)
Interfaces	0.6 kg / 35 x 130 x 125 mm
General data	Plug-in screw connection
Weight / Dimensions W x H x D	0.2 - 2.5 mm <sup>2</sup> / 0.2 - 2.5 mm <sup>2</sup> / 16 - 12
Connection method	Signal connection data (solid / stranded / AWG)
Connection data input/output solid / stranded / AWG	0.2 - 2.5 mm <sup>2</sup> / 0.2 - 2.5 mm <sup>2</sup> / 24 - 12
Signal connection data (solid / stranded / AWG)	Degree of protection / Protection class
Degree of protection / Protection class	IP20 / III
Ambient temperature (operation)	-25°C ... 70°C
Derating	60°C ... 70°C (2.5%/K)
Standards/regulations	UL Listed UL 508, UL/C-UL Recognized UL 60950
UL approvals	

#### Ordering data

Description	Type	Order No.	Pcs. / Pkt.
Power supply, uninterruptible	QUINT-UPS/ 24DC/12DC/5/24DC/10	2320461	1

**QUINT UPS for AC applications**

The UPS module for 120 V AC/230 V AC with 400 W/500 VA power can be combined with all UPS-CAP and UPS-BAT power storage devices.

Optimum use of the buffer time and preventive monitoring of the power storage:

- Detects the current state of charge of the power storage and calculates the remaining runtime
- Calculates the current life expectancy of the power storage

Worldwide use:

- Input voltages from 96 to 264 V AC
- Storage of the level and frequency of the input voltage, in the event of mains failure, the output is automatically supplied with 120 V AC/60 Hz or 230 V AC/50 Hz
- Manual voltage pre-selection possible

Maximum energy efficiency:

- Offline operation: 98% efficiency for charged power storage
- Power factor  $\cos \phi$  0.8

Extensive signaling and parameterization:

- Switching outputs
- USB interface
- Data port
- Parameterization with memory module

Simplified startup:

- The UPS can be switched on without a power supply network (cold restart)

**Notes:**  
The buffer time associated with your solution is dependent on the load current. Exact details for each uninterruptible power supply can be found on page 233.



**Uninterruptible power supply, 1 AC/1AC, 500 VA**

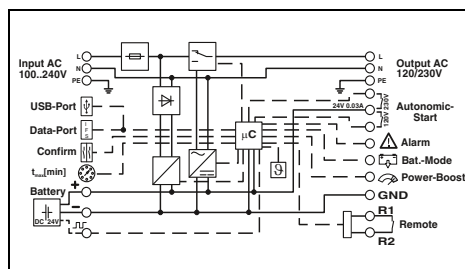

**Technical data**

<b>General input data</b>	180 V AC ... 264 V AC 45 Hz ... 65 Hz $U_N \pm 10\%$ . Can be configured using UPS-CONF software.	
<b>Input data</b>	120 V AC	230 V AC
Nominal input voltage	120 V AC	230 V AC
Input voltage range AC	102 V AC ... 138 V AC	196 V AC ... 264 V AC
Nominal frequency	50 Hz ... 60 Hz	50 Hz ... 60 Hz
Max. current consumption ( $I_{IN} = I_{CHARGE} + I_{BOOST}$ )	6.8 A	3.7 A
<b>General output data</b>	400 W / 500 VA > 50°C ... 70°C (2.5%/K) < 10 ms > 98% (mains operation)	
<b>Output data (mains operation)</b>	120 V AC	230 V AC
Nominal output voltage	120 V AC	230 V AC
Output voltage range	102 V AC ... 138 V AC	196 V AC ... 264 V AC
- Nominal output current $I_N$ (continual)	4.3 A (-25°C ... 70°C)	2.2 A (-25°C ... 70°C)
- POWER BOOST $I_{BOOST}$ (continual)	5.2 A (-25°C ... 70°C)	2.7 A (-25°C ... 70°C)
<b>Output data (battery operation)</b>	120 V AC	230 V AC
Nominal output voltage	120 V AC	230 V AC
- Nominal output current $I_N$ (continual)	4.3 A (-25°C ... 50°C)	2.2 A (-25°C ... 50°C)
- POWER BOOST $I_{BOOST}$ (5 s)	5.2 A (-25°C ... 50°C)	2.7 A (-25°C ... 50°C)
<b>Power storage</b>	24 V DC 25 V DC ... 30 V DC (temperature compensated) 3 Ah ... 200 Ah 0.2 A ... 2 A	
<b>Signaling</b>	LED, active switching outputs, interface/software	
<b>Interfaces</b>	IFS (Interface system data port), MINI-USB type B	
<b>General data</b>	VFD-SS-311 2.2 kg / 125 x 130 x 125 mm Screw connection 1.5 - 6 mm <sup>2</sup> / 1.5 - 4 mm <sup>2</sup> / 18 - 10 0.2 - 2.5 mm <sup>2</sup> / 0.2 - 2.5 mm <sup>2</sup> / 24 - 10 IP20 / I -25°C ... 70°C (> 50°C derating: 2.5%/K)	
<b>Standards/regulations</b>	UL/C-UL Recognized UL 1778	

**Ordering data**

Description	Type	Order No.	Pcs. / Pkt.
Power supply, uninterruptible	QUINT-UPS/ 1AC/ 1AC/500VA	2320270	1

# Power supplies and UPS

## Uninterruptible power supply units for the control cabinet

### Power storage for QUINT UPS

#### Maintenance-free CAP UPS

- Dual layer capacitors
- Life expectancy: >20 years (20°C), >8 years (50°C)
- Communication with QUINT UPS
- Integrated temperature sensor
- Works reliably, even under extreme ambient temperatures of -40°C to +60°C



Maintenance-free power storage,  
24 V DC, 10 A, 10 kJ



Maintenance-free power storage,  
24 V DC, 20 A, 20 kJ



Ex:

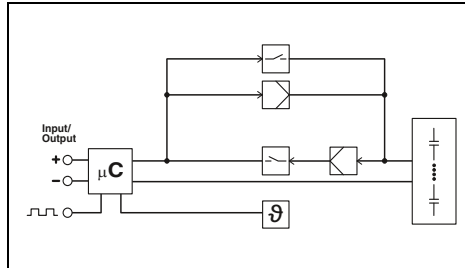

#### Technical data

Input data	
Input voltage range	18 V DC ... 30 V DC
Nominal capacity	0.1 Ah
Output data	
Nominal output voltage	24 V DC
Output voltage range	22 V DC ... 27 V DC
Output current	10 A
Output fuse	1x 25 A (internal)
Can be connected in parallel / series	No / No
Buffer period	6 min (1 A) / 33 s (10 A)
General data	
Storage medium	Dual layer capacitor
Weight / Dimensions W x H x D	1.7 kg / 126 x 130 x 126 mm
Degree of protection / Protection class	IP20 / III
Ambient temperature (operation)	-40°C ... 60°C
Ambient temperature (storage/transport)	-40°C ... 60°C
Service life	20 years (20°C)
Standards/regulations	
UL approvals	UL Listed UL 508, UL/C-UL Recognized UL 60950
GL approvals	
GL applied for	GL applied for



Ex:

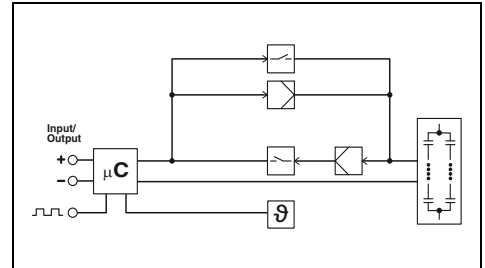

#### Technical data

Input data	
Input voltage range	18 V DC ... 30 V DC
Nominal capacity	0.2 Ah
Output data	
Nominal output voltage	24 V DC
Output voltage range	22 V DC ... 27 V DC
Output current	20 A
Output fuse	2x 25 A (internal)
Can be connected in parallel / series	No / No
Buffer period	12 min (1 A) / 33 s (20 A)
General data	
Storage medium	Dual layer capacitor
Weight / Dimensions W x H x D	2.9 kg / 150 x 130 x 176 mm
Degree of protection / Protection class	IP20 / III
Ambient temperature (operation)	-40°C ... 60°C
Ambient temperature (storage/transport)	-40°C ... 60°C
Service life	20 years (20°C)
Standards/regulations	
UL approvals	UL Listed UL 508, UL/C-UL Recognized UL 60950
GL approvals	
GL applied for	GL applied for

#### Ordering data

Description	Ordering data		
	Type	Order No.	Pcs. / Pkt.
Power storage	UPS-CAP/24DC/10A/10KJ	2320377	1

#### Ordering data

Description	Ordering data		
	Type	Order No.	Pcs. / Pkt.
Power storage	UPS-CAP/24DC/20A/20KJ	2320380	1



Power storage for QUINT UPS

UPS-BAT/LI-ION for long service life with long buffer times

- Lithium-ion technology
- Works reliably, even under extreme ambient temperatures of -20 to +58°C
- Communication with QUINT UPS
- Integrated temperature sensor for optimum charging
- Battery can be changed without tools



LI-ION power storage, 120 Wh

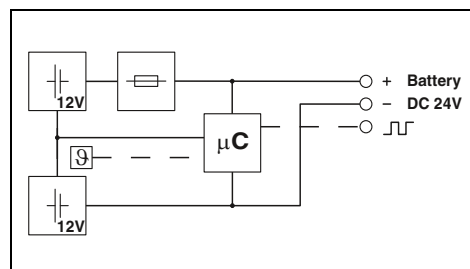

Input data/output data	
Nominal input voltage	24 V DC
Nominal capacity	120 Wh
Output current	30 A
Output fuse	1x 30 A
Can be connected in parallel / series	Yes / No
Buffer period	14 min (20 A)
General data	
Storage medium	LI-ION, 120 Wh
Weight / Dimensions W x H x D	2,9 kg / 135 x 202 x 110 mm
Degree of protection / Protection class	IP20 / III
Ambient temperature (operation)	-20°C ... 60°C
Service life	15 years (20°C)
Standards/regulations	
UL approvals	UL/C-UL listed UL 508, UL/C-UL Recognized UL 60950, UL ANSI/ISA-12.12.01 Class I, Division 2, Groups A, B, C, D (Hazardous Location)

Technical data

Description	
<b>Power storage</b>	

Ordering data

Type	Order No.	Pcs. / Pkt.
UPS-BAT/LI-ION/24DC/120WH	2320351	1

# Power supplies and UPS

## Uninterruptible power supply units for the control cabinet

### Power storage for QUINT UPS

#### UPS BAT/VRLA for maximum buffer times

- Lead AGM (Absorbent Glass Mat) technology
- Ambient temperatures from 0 to +40°C
- Long buffer times for high currents
- Communication with QUINT UPS
- Integrated temperature sensor for optimum charging
- Battery can be changed without tools



VRLA power storage, 1.3 Ah



VRLA power storage, 3.4 Ah

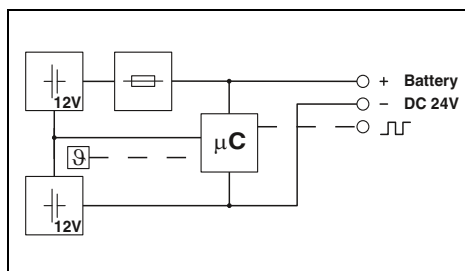

#### Technical data

Input data/output data	
Nominal input voltage	24 V DC
Nominal capacity	1.3 Ah
Output current	15 A
Output fuse	1x 15 A
Can be connected in parallel / series	Yes / No
Buffer period	20 min (2 A) / 5 min (5 A)
General data	
Storage medium	Lead rechargeable battery module
Weight / Dimensions W x H x D	1.7 kg / 54 x 157 x 113 mm
Degree of protection / Protection class	IP20 / III
Ambient temperature (operation)	0°C ... 40°C
Service life	6 years ... 9 years (20°C)
Standards/regulations	UL/C-UL listed UL 508, UL/C-UL Recognized UL 60950, UL ANSI/ISA-12.12.01 Class I, Division 2, Groups A, B, C, D (Hazardous Location)
UL approvals	

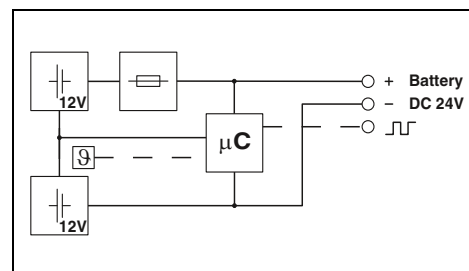

#### Technical data

Description	
Power storage	
Mounting set	

Ordering data		
Type	Order No.	Pcs. / Pkt.
UPS-BAT/VRLA/24DC/ 1.3AH	2320296	1

Accessories		

Ordering data		
Type	Order No.	Pcs. / Pkt.
UPS-BAT/VRLA/24DC/ 3.4AH	2320306	1

Accessories		

Uninterruptible power supply units for the control cabinet



VRLA power storage, 7.2 Ah



VRLA power storage, 12 Ah



VRLA power storage, 38 Ah

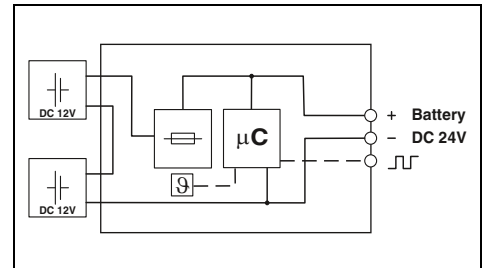
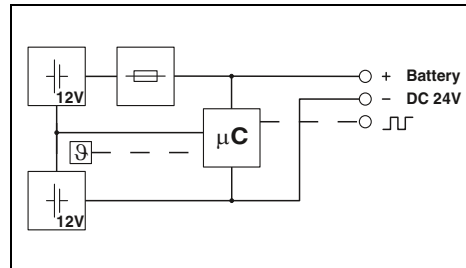
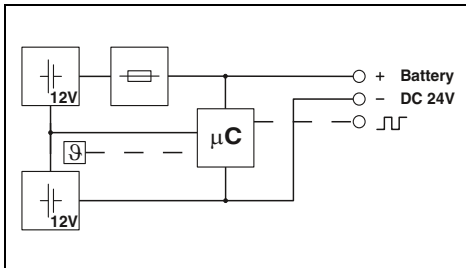

Technical data

24 V DC  
7.2 Ah  
50 A  
2x 25 A  
Yes / No  
10 min (20 A) / 3 min (40 A)

Lead rechargeable battery module  
5.9 kg / 135 x 202 x 110 mm  
IP20 / III  
0°C ... 40°C  
6 years ... 9 years (20°C)

UL/C-UL listed UL 508, UL/C-UL Recognized UL 60950,  
UL ANSI/ISA-12.12.01 Class I, Division 2, Groups A, B, C, D  
(Hazardous Location)

Ordering data

Type	Order No.	Pcs. / Pkt.
UPS-BAT/VRLA/24DC/ 7.2AH	2320319	1

Accessories

--	--	--

Technical data

24 V DC  
12 Ah  
50 A  
2x 25 A  
Yes / No  
22.5 min (20 A) / 9 min (40 A)

Lead rechargeable battery module  
8.9 kg / 202 x 202 x 110 mm  
IP20 / III  
0°C ... 40°C  
6 years ... 9 years (20°C)

UL/C-UL listed UL 508, UL/C-UL Recognized UL 60950,  
UL ANSI/ISA-12.12.01 Class I, Division 2, Groups A, B, C, D  
(Hazardous Location)

Ordering data

Type	Order No.	Pcs. / Pkt.
UPS-BAT/VRLA/24DC/12AH	2320322	1

Accessories

--	--	--

Technical data

24 V DC  
38 Ah  
45 A  
2x 25 A ATOF 32V  
Yes / No  
72 min (20 A) / 35 min (40 A)

Lead rechargeable battery module  
26 kg / 330 x 221 x 197 mm  
IP20 / III  
0°C ... 40°C  
10 years ... 12 years (20°C)

UL/C-UL listed UL 508, UL/C-UL Recognized UL 60950,  
UL ANSI/ISA-12.12.01 Class I, Division 2, Groups A, B, C, D  
(Hazardous Location)

Ordering data

Type	Order No.	Pcs. / Pkt.
UPS-BAT/VRLA/24DC/38AH	2320335	1

Accessories

BATTERY MOUNTING CASE	2320458	1
-----------------------	---------	---

# Power supplies and UPS

## Uninterruptible power supply units for the control cabinet

### Power storage for QUINT UPS

#### UPS BAT/VRLA-WTR for temperatures from -25 to +60°C

- Pure lead AGM technology
- Communication with QUINT UPS
- Integrated temperature sensor for optimum charging



Power storage with wide temperature range  
24 V DC, 13 Ah



Power storage with wide temperature range  
24 V DC, 26 Ah

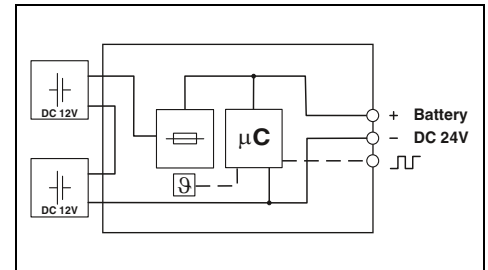
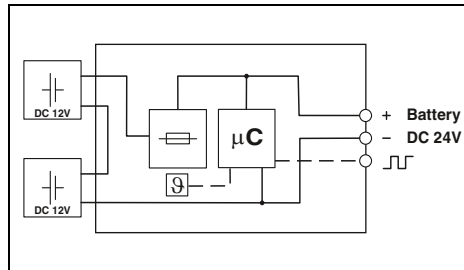

#### Technical data

Input data/output data	
Nominal input voltage	24 V DC
Nominal capacity	13 Ah
Output current	45 A
Output fuse	2x 25 A ATOF 32V
Can be connected in parallel / series	Yes / No
Buffer period	50 min (10 A) / 10 min (40 A)
General data	
Storage medium	Pure lead AGM
Weight / Dimensions W x H x D	10.8 kg / 172 x 177 x 178 mm
Degree of protection / Protection class	IP20 / III
Ambient temperature (operation)	-25°C ... 60°C
Ambient temperature (storage/transport)	-40°C ... 60°C
Service life	10 years ... 15 years (20°C)
Standards/regulations	
UL approvals	UL/C-UL listed UL 508, UL/C-UL Recognized UL 60950
GL approvals	
GL applied for	GL applied for

#### Technical data

Input data/output data	
Nominal input voltage	24 V DC
Nominal capacity	26 Ah
Output current	45 A
Output fuse	2x 25 A ATOF 32V
Can be connected in parallel / series	Yes / No
Buffer period	120 min (10 A) / 30 min (40 A)
General data	
Storage medium	Pure lead AGM
Weight / Dimensions W x H x D	21.6 kg / 358 x 174 x 169 mm
Degree of protection / Protection class	IP20 / III
Ambient temperature (operation)	-25°C ... 60°C
Ambient temperature (storage/transport)	-40°C ... 60°C
Service life	10 years ... 15 years (20°C)
Standards/regulations	
UL approvals	UL/C-UL listed UL 508, UL/C-UL Recognized UL 60950
GL approvals	
GL applied for	GL applied for

#### Ordering data

Description	Type	Order No.	Pcs. / Pkt.
Power storage	UPS-BAT/VRLA-WTR/24DC/13AH	2320416	1

#### Ordering data

Description	Type	Order No.	Pcs. / Pkt.
Power storage	UPS-BAT/VRLA-WTR/24DC/26AH	2320429	1

#### Accessories

Accessories	Order No.	Pcs. / Pkt.
BATTERY MOUNTING CASE	2320458	1

#### Accessories

Accessories	Order No.	Pcs. / Pkt.
BATTERY MOUNTING CASE	2320458	1



# Power supplies and UPS

## Uninterruptible power supply units for the control cabinet

### Configuration software for QUINT UPS

The UPS CONF configuration software can be downloaded free of charge from our homepage. Remember to order the IFS-USB-DATACABLE as well in order to use the software.

#### Supported operating systems:

- Windows 8.1 (32 and 64-bit)
- Windows 8.0 (32 and 64-bit)
- Windows 7 (32 and 64-bit)
- Windows Vista
- Windows XP

#### Minimum requirements:

- Display: 800 x 600, 256 colors
- Processor: 400 MHz, Pentium processor or similar
- RAM: 96 MB



Ordering data			
Description	Type	Order No.	Pcs. / Pkt.
Configuration software for QUINT UPS	UPS-CONF	2320403	1

### Accessories for QUINT UPS and TRIO UPS

IFS-USB-DATACABLE is required for communication between the uninterruptible power supply and the UPS CONF configuration software.

IFS-CONFSTICK for storing the values you have configured and transferring them to other uninterruptible power supplies.



Description	Ordering data			Ordering data		
	Type	Order No.	Pcs. / Pkt.	Type	Order No.	Pcs. / Pkt.
<b>Programming adapter</b> for configuring modules with S-PORT interface Cable length: 3 m	IFS-USB-DATACABLE	2320500	1	IFS-CONFSTICK	2986122	1
<b>Multi-functional memory module</b> for the INTERFACE system				IFS-CONFSTICK-L	2901103	1
- Flat design - Tall design						

Accessories for QUINT UPS

**IFS-RS232-DATACABLE**

- For Modbus communication with the RS-232 interface
- Connection to the Phoenix Contact COM server for Ethernet communication
- Communicate directly with higher-level controllers, such as Phoenix Contact ILC or RFC, or use as a gateway



**IFS-MINI-DIN-DATACABLE**

- For direct communication with the ILC from the Phoenix Contact Inline system

**IFS-OPEN-END-DATACABLE**

- Open cable for flexible communication

**QUINT UPS function blocks**

- For further processing of information communicated via data cables
- For PC Worx software
- Free download at phoenixcontact.net/products

Description
<b>Data cable</b> for communication between higher-level controllers and QUINT UPS uninterruptible power supplies, cable length: 2 m
Modbus communication
Direct communication
Flexible communication

Ordering data		
Type	Order No.	Pcs. / Pkt.
IFS-RS232-DATACABLE	2320490	1
IFS-MINI-DIN-DATACABLE	2320487	1
IFS-OPEN-END-DATACABLE	2320450	1

Mounting set

new

**Battery mounting kit**

- For attaching individual battery blocks to a mounting plate
- Consists of four powder-coated metal brackets and a fabric lashing strap



**Battery mounting case**

- Battery frame for universal wall or surface mounting



Ordering data		
Type	Order No.	Pcs. / Pkt.
BATTERY MOUNTING KIT	2320788	1

Ordering data		
Type	Order No.	Pcs. / Pkt.
BATTERY MOUNTING CASE	2320458	1

Description
Mounting set

# Power supplies and UPS

## Uninterruptible power supply units for the control cabinet

### Selection of UPS modules with integrated power storage or integrated power supply

To save space in the control cabinet or to retrofit existing systems easily, UPS versions with integrated power storage (QUINT, UNO, and STEP) or integrated power supply (MINI and TRIO) are recommended.



### UNO UPS selection table

Select your UNO UPS here

Load current	Buffer time																					
	Seconds						Minutes															
	0.2	0.4	1	2	8	16	1	2	3	4	5	6	7	8	9	10	20	30	40	45		
0.5 A	■	■	■	■	■	■	■	■	■	■	■	■	■	■	■	■	■	■	■	■	■	■
1 A	■	■	■	■	■	■	■	■	■	■	■	■	■	■	■	■	■	■	■	■	■	■
1.5 A	■	■	■	■	■	■	■	■	■	■	■	■	■	■	■	■	■	■	■	■	■	■
2 A	■	■	■	■	■	■	■	■	■	■	■	■	■	■	■	■	■	■	■	■	■	■
2.5 A	■	■	■	■	■	■	■	■	■	■	■	■	■	■	■	■	■	■	■	■	■	■

■ UNO-UPS-1G/24DC/24DC/60W

### STEP UPS selection table

Select your STEP UPS here

Load current	Buffer time																						
	Seconds						Minutes																
	0.2	0.4	1	2	8	16	1	2	3	4	5	6	7	8	9	10	15	20	25	30	40	45	50
0.5 A	■	■	■	■	■	■	■	■	■	■	■	■	■	■	■	■	■	■	■	■	■	■	■
1 A	■	■	■	■	■	■	■	■	■	■	■	■	■	■	■	■	■	■	■	■	■	■	■
2 A	■	■	■	■	■	■	■	■	■	■	■	■	■	■	■	■	■	■	■	■	■	■	■
3 A	■	■	■	■	■	■	■	■	■	■	■	■	■	■	■	■	■	■	■	■	■	■	■

■ STEP-UPS/24DC/24DC/3

Note:

With the STEP-UPS/12DC/12DC/4, buffer times are double those of the STEP-UPS/24DC/24DC/3.



### Buffer times for UPS with integrated power storage

Particularly space-saving and easy to retrofit, the UPS module and power storage are combined in the same housing. The maintenance-free buffer module is available with 40 A load current. It's just a case of connecting a power supply upstream and the reliable UPS solution is complete.

Select your QUINT UPS and QUINT BUFFER here.

Example: 5 A needs to be buffered for 20 minutes.

Solution: QUINT-UPS/24DC/24DC/10/3.4AH

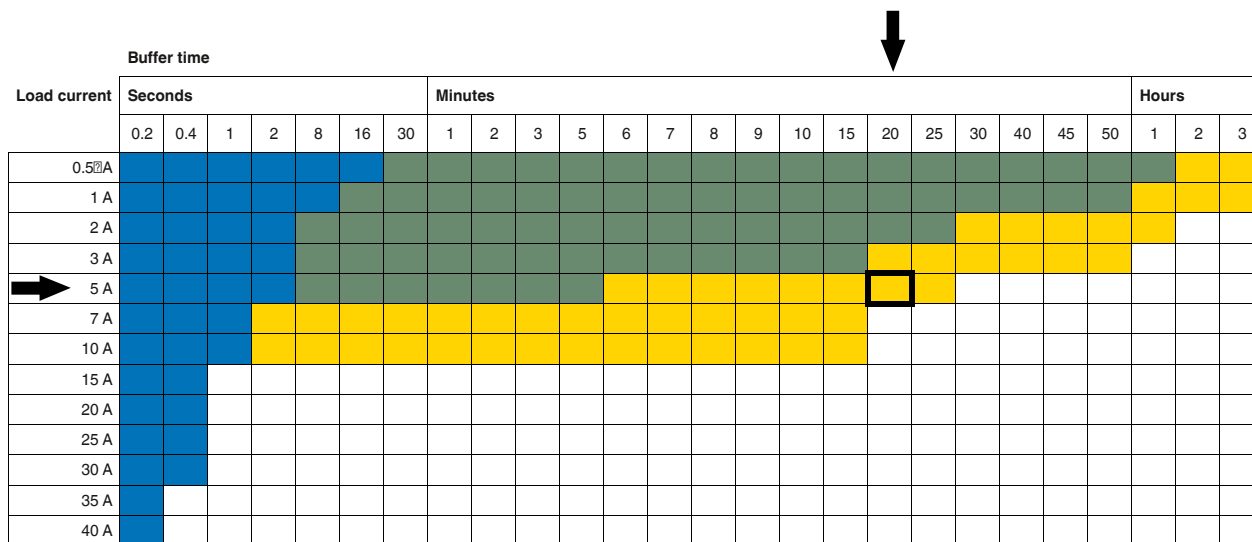

QUINT UPS: ■ QUINT-UPS/24DC/24DC/5/1.3AH, ■ QUINT-UPS/24DC/24DC/10/3.4AH  
 QUINT BUFFER: ■ QUINT-BUFFER/24DC/24DC/40

### Power storage for MINI UPS and TRIO UPS

The UPS module and power supply are combined in the same housing in a particularly space-saving way. Only one power storage is required to complete the UPS system.

#### MINI UPS

Power storage with lead AGM technology for output voltages of 24 or 12 V DC. Buffer times of up to 50 minutes with 1 A load current.

Note: with the MINI-DC-UPS/12DC/4, buffer times are double those of the MINI-DC-UPS/24DC/2.

#### TRIO UPS

Power storage devices with lead AGM technology buffer failures lasting up to 2 hours with 5 A load current.

Select your MINI-BAT and QUINT-BAT for MINI UPS and TRIO UPS here.

Example: 2 A needs to be buffered for 20 minutes.

Solution: MINI-BAT/24DC/1.3AH

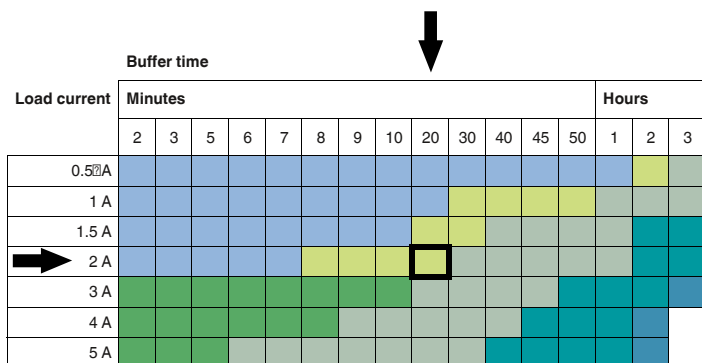

MINI-BAT for MINI-UPS: ■ MINI-BAT/24DC/0.8AH, ■ QUINT-BAT/24DC/7.2AH  
■ MINI-BAT/24DC/1.3AH, ■ QUINT-BAT/24DC/12AH  
 MINI-BAT for TRIO-UPS: ■ MINI-BAT/24DC/1.3AH  
■ QUINT-BAT/24DC/3.4AH

# Power supplies and UPS

## Uninterruptible power supply units for the control cabinet

### UPS module with integrated power storage

QUINT-UPS is very easy to install in existing systems. It's just a case of connecting a 24 V DC power supply unit upstream and the reliable UPS solution is complete.

- Advantages of using IQ technology
- Minimal wiring effort
- Maintenance-free power storage with lead AGM technology

**Notes:**  
The buffer time associated with your solution is dependent on the load current. Exact details for each uninterruptible power supply can be found on page 233.



Uninterruptible power supply with integrated power storage, 24 V DC / 24 V DC, 5 A, 1.3 Ah



Uninterruptible power supply with integrated power storage, 24 V DC / 24 V DC, 10 A, 3.4 Ah

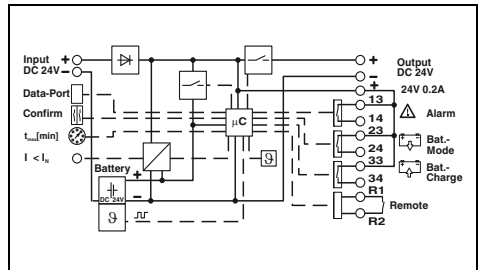
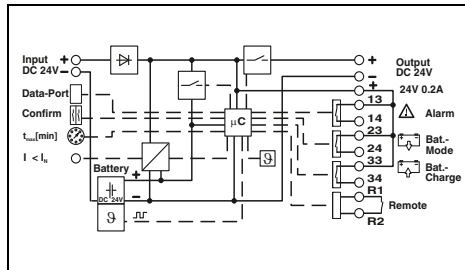

#### Technical data

Input data	
Input voltage range	18 V DC ... 30 V DC
Max. current consumption	9.3 A (24 V DC)
Output data	
Nominal output voltage	24 V DC
Output voltage range	19.2 V DC ... 27.6 V DC ( $U_{OUT} = U_{BAT} - 0.5 \text{ V DC}$ )
Output current	5 A
Can be connected in parallel / series	Yes / No
Buffer period	50 min (1 A) / 5 min (5 A)
Max. power dissipation (normal mode / buffer mode)	2.5 W / 3.3 W
Efficiency (typ.)	> 97.1% (mains operation, with charged power storage)
Signaling	
Signaling	LED, relay contact, interface/software
Interfaces	IFS (Interface system data port)
General data	
Storage medium	Lead rechargeable battery module 1.3 Ah
Weight / Dimensions W x H x D	2.2 kg / 88 x 138 x 125 mm
Installation position	horizontal DIN rail NS 35, EN 60715
Spacing when mounting	Alignable: horizontally 5 mm, vertically 50 mm
Connection method	Plug-in screw connection
Input connection data (solid / stranded / AWG)	0.2 - 2.5 mm <sup>2</sup> / 0.2 - 2.5 mm <sup>2</sup> / 20 - 12
Output connection data (solid / stranded / AWG)	0.2 - 2.5 mm <sup>2</sup> / 0.2 - 2.5 mm <sup>2</sup> / 20 - 12
Signal connection data (solid / stranded / AWG)	0.2 - 2.5 mm <sup>2</sup> / 0.2 - 2.5 mm <sup>2</sup> / 24 - 12
Degree of protection / Protection class	IP20 / III
MTBF (IEC 61709, SN 29500)	> 806000 h (40°C)
Ambient temperature (operation)	0°C ... 40°C
Ambient temperature (storage/transport)	-15°C ... 40°C
Service life	6 years ... 9 years (20°C)
Latest startup	9 months (20°C ... 30°C) 6 months (30°C ... 40°C)
Standards/regulations	
Electromagnetic compatibility	Conformance with EMC Directive 2004/108/EC
Electrical safety, safety transformer	EN 60950-1/VDE 0805 (SELV)
Electronic equipm. for electrical power installations	EN 50178/VDE 0160 (PELV)
UL approvals	UL/C-UL Recognized UL 60950, UL Listed UL 508

#### Technical data

Input data	
Input voltage range	18 V DC ... 30 V DC
Max. current consumption	18.6 A (24 V DC)
Output data	
Nominal output voltage	24 V DC
Output voltage range	19.2 V DC ... 27.6 V DC ( $U_{OUT} = U_{BAT} - 0.5 \text{ V DC}$ )
Output current	10 A
Can be connected in parallel / series	Yes / No
Buffer period	180 min (1 A) / 10 min (10 A)
Max. power dissipation (normal mode / buffer mode)	3.1 W / 6.3 W
Efficiency (typ.)	> 97.6% (mains operation, with charged power storage)
Signaling	
Signaling	LED, relay contact, interface/software
Interfaces	IFS (Interface system data port)
General data	
Storage medium	Lead rechargeable battery module, 3.4 Ah
Weight / Dimensions W x H x D	3.8 kg / 120 x 169 x 125 mm
Installation position	horizontal DIN rail NS 35, EN 60715
Spacing when mounting	Alignable: horizontally 5 mm, vertically 50 mm
Connection method	Plug-in screw connection
Input connection data (solid / stranded / AWG)	0.2 - 2.5 mm <sup>2</sup> / 0.2 - 2.5 mm <sup>2</sup> / 16 - 12
Output connection data (solid / stranded / AWG)	0.2 - 2.5 mm <sup>2</sup> / 0.2 - 2.5 mm <sup>2</sup> / 16 - 12
Signal connection data (solid / stranded / AWG)	0.2 - 2.5 mm <sup>2</sup> / 0.2 - 2.5 mm <sup>2</sup> / 24 - 12
Degree of protection / Protection class	IP20 / III
MTBF (IEC 61709, SN 29500)	> 806000 h (40°C)
Ambient temperature (operation)	0°C ... 40°C
Ambient temperature (storage/transport)	-15°C ... 40°C
Service life	6 years ... 9 years (20°C)
Latest startup	9 months (20°C ... 30°C) 6 months (30°C ... 40°C)
Standards/regulations	
Electromagnetic compatibility	Conformance with EMC Directive 2004/108/EC
Electrical safety, safety transformer	EN 60950-1/VDE 0805 (SELV)
Electronic equipm. for electrical power installations	EN 50178/VDE 0160 (PELV)
UL approvals	UL/C-UL Recognized UL 60950, UL Listed UL 508

#### Ordering data

Description	Type	Order No.	Pcs. / Pkt.
Power supply, uninterruptible	QUINT-UPS/ 24DC/ 24DC/ 5/1.3AH	2320254	1

#### Ordering data

Description	Type	Order No.	Pcs. / Pkt.
Power supply, uninterruptible	QUINT-UPS/ 24DC/ 24DC/ 10/3.4AH	2320267	1

**Maintenance-free buffer module**

The buffer module can accommodate failures lasting several seconds.

It combines an electronic switch-over unit and a capacitor-based power storage in the same housing.

**Notes:**  
The buffer time associated with your solution is dependent on the load current. Exact details for each uninterruptible power supply can be found on page 233.



**Buffer module,  
24 V DC / 24 V DC, 40 A**

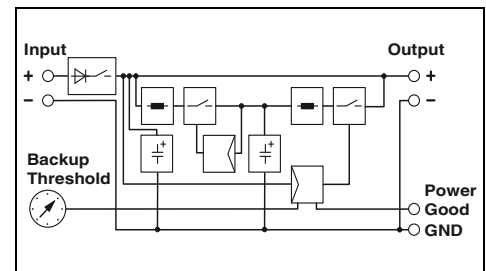

**Technical data**

<b>Input data</b>	18 V DC ... 30 V DC 0.1 A (no-load) 0.1 A / 0.7 A / 45 A < 20 V DC (< 22 V; < 24 V; < 26 V), (U <sub>N</sub> - 1 V)/0.1 s
<b>Output data</b>	24 V DC (depending on the input voltage) 40 A / 120 A Yes / No 0.2 s (40 A) / 8 s (1 A) 8 W / 48 W  > 99% (mains operation, with charged power storage)
<b>Signaling</b>	LED, active switching output
<b>General data</b>	Electrolytic capacitor 1.1 kg / 64 x 130 x 125 mm horizontal DIN rail NS 35, EN 60715 Alignable: horizontally 0 mm, vertically 50 mm Screw connection 0.5 - 16 mm <sup>2</sup> / 0.5 - 16 mm <sup>2</sup> / 8 - 6 0.5 - 16 mm <sup>2</sup> / 0.5 - 16 mm <sup>2</sup> / 8 - 6 0.2 - 4 mm <sup>2</sup> / 0.2 - 2.5 mm <sup>2</sup> / 24 - 12 IP20 / III > 902000 h (40°C) -25°C ... 80°C
<b>Standards/regulations</b>	500 V Conformance with EMC Directive 2004/108/EC EN 60950-1/VDE 0805 (SELV) EN 50178/VDE 0160 (PELV) UL/C-UL Recognized UL 60950, UL Listed UL 508, UL ANSI/ISA-12.12.01 Class I, Division 2, Groups A, B, C, D (Hazardous Location)

**Ordering data**

Description	Type	Order No.	Pcs. / Pkt.
<b>Power supply, uninterruptible</b>	QUINT-BUFFER/24DC/24DC/40	2320393	1

# Power supplies and UPS

## Uninterruptible power supply units for the control cabinet

### UPS module with integrated power storage

#### STEP UPS

The STEP BAT power supply unit is included as part of the STEP UPS order. The STEP BAT can be reordered separately. (See accessories on this page)

**Notes:**  
 With the STEP-UPS/12DC/12DC/4, buffer times are double those of the STEP-UPS/24DC/24 DC/3. See page 233.  
 The buffer time associated with your solution is dependent on the load current. Exact details for each uninterruptible power supply can be found on page 233.



**Uninterruptible power supply with integrated rechargeable battery, 24 V DC/24 V DC, 3 A**

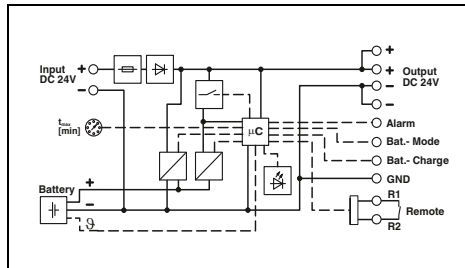

#### Technical data

Input data	
Input voltage range	22.5 V DC ... 29.5 V DC
Max. current consumption	4.7 A
Current consumption charging process	0.5 A
Input fuse	7 A (slow-blow, internal)
Output data	
Nominal output voltage	24 V DC
Output current standard operation	3 A
Output current POWER BOOST	4 A (0°C ... 35°C)
Can be connected in parallel / series	No / No
Buffer period	50 min (1 A) / 25 min (2 A)
Max. power dissipation (normal mode / buffer mode)	2 W / 3.8 W
Efficiency (typ.)	> 98% (mains operation, with charged power storage)
Signaling	
Signaling Power OK	LED
Signaling alarm	LED, active transistor switching output
Signaling battery charge	LED, active transistor switching output
Signaling battery mode	LED, active transistor switching output
General data	
Storage medium	Lithium polymer
Weight / Dimensions W x H x D	0.45 kg / 108 x 90 x 61 mm
Installation position	horizontal DIN rail NS 35, EN 60715
Spacing when mounting	Alignable: horizontally 0 mm, vertically 50 mm
Connection method	Screw connection
Input connection data (solid / stranded / AWG)	0.2 - 2.5 mm <sup>2</sup> / 0.2 - 2.5 mm <sup>2</sup> / 24 - 12
Output connection data (solid / stranded / AWG)	0.2 - 2.5 mm <sup>2</sup> / 0.2 - 2.5 mm <sup>2</sup> / 24 - 12
Signal connection data (solid / stranded / AWG)	0.2 - 2.5 mm <sup>2</sup> / 0.2 - 2.5 mm <sup>2</sup> / 24 - 12
Degree of protection / Protection class	IP20 / III
MTBF (IEC 61709, SN 29500)	> 1401000 h (40°C)
Ambient temperature (operation)	0°C ... 40°C
Standards/regulations	
Electromagnetic compatibility	Conformance with EMC Directive 2004/108/EC
Electrical safety, safety transformer	EN 60950-1/VDE 0805 (SELV)
Electronic equipm. for electrical power installations	EN 50178/VDE 0160 (PELV)
UL approvals	UL Listed UL 508, UL/C-UL Recognized UL 60950



**Uninterruptible power supply with integrated battery module, 12 V DC/12 V DC, 4 A**

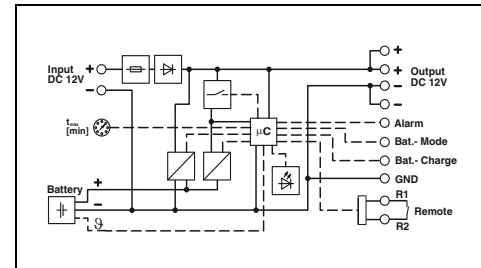

#### Technical data

Input data	
Input voltage range	10 V DC ... 16.5 V DC
Max. current consumption	6 A
Current consumption charging process	0.8 A
Input fuse	7 A (slow-blow, internal)
Output data	
Nominal output voltage	12 V DC
Output current standard operation	4 A
Output current POWER BOOST	5 A (0°C ... 35°C)
Can be connected in parallel / series	No / No
Buffer period	100 min (1 A) / 50 min (2 A)
Max. power dissipation (normal mode / buffer mode)	1.2 W / 4.4 W
Efficiency (typ.)	> 97.4% (mains operation, with charged power storage)
Signaling	
Signaling Power OK	LED
Signaling alarm	LED, active transistor switching output
Signaling battery charge	LED, active transistor switching output
Signaling battery mode	LED, active transistor switching output
General data	
Storage medium	Lithium polymer
Weight / Dimensions W x H x D	0.46 kg / 108 x 90 x 61 mm
Installation position	horizontal DIN rail NS 35, EN 60715
Spacing when mounting	Alignable: horizontally 0 mm, vertically 50 mm
Connection method	Screw connection
Input connection data (solid / stranded / AWG)	0.2 - 2.5 mm <sup>2</sup> / 0.2 - 2.5 mm <sup>2</sup> / 24 - 12
Output connection data (solid / stranded / AWG)	0.2 - 2.5 mm <sup>2</sup> / 0.2 - 2.5 mm <sup>2</sup> / 24 - 12
Signal connection data (solid / stranded / AWG)	0.2 - 2.5 mm <sup>2</sup> / 0.2 - 2.5 mm <sup>2</sup> / 24 - 12
Degree of protection / Protection class	IP20 / III
MTBF (IEC 61709, SN 29500)	> 1997000 h (40°C)
Ambient temperature (operation)	0°C ... 40°C
Standards/regulations	
Electromagnetic compatibility	Conformance with EMC Directive 2004/108/EC
Electrical safety, safety transformer	EN 60950-1/VDE 0805 (SELV)
Electronic equipm. for electrical power installations	EN 50178/VDE 0160 (PELV)
UL approvals	UL Listed UL 508, UL/C-UL Recognized UL 60950

#### Ordering data

Description	Type	Order No.	Pcs. / Pkt.
Power supply, uninterruptible	STEP-UPS/24DC/24DC/3	2868703	1

#### Accessories

Power storage	Type	Order No.	Pcs. / Pkt.
	STEP-BAT/LIPO/18.5DC/1.4AH	2320364	1

#### Ordering data

Description	Type	Order No.	Pcs. / Pkt.
Power supply, uninterruptible	STEP-UPS/12DC/12DC/4	2868693	1

#### Accessories

Power storage	Type	Order No.	Pcs. / Pkt.
	STEP-BAT/LIPO/18.5DC/1.4AH	2320364	1

Uninterruptible power supply units for the control cabinet

**UPS module with integrated power storage**

**UNO UPS**

The power storage is included when ordering UNO UPS.

**Notes:**  
The buffer time associated with your solution is dependent on the load current. Exact details for each uninterruptible power supply can be found on page 233.



new



**Uninterruptible power supply with integrated rechargeable battery, 24 V DC/24 V DC, 60 W**

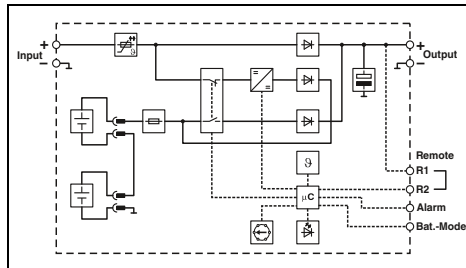

**Technical data**

<b>Input data</b>	
Input voltage range	23 V DC ... 30 V DC
Max. current consumption	2.9 A
Current consumption charging process	-
Input fuse	5 A (electronic)
<b>Output data</b>	
Nominal output voltage	24 V DC
Output current standard operation	2.5 A
Output current POWER BOOST	-
Can be connected in parallel / series	Yes, with redundancy module / No
Buffer period	45 min (0.5 A) / 20 min (1 A)
Max. power dissipation (normal mode / buffer mode)	3.3 W / 6 W
Efficiency (typ.)	> 95% (mains operation, with charged power storage)
<b>Signaling</b>	
Signaling Power OK	LED
Signaling alarm	LED, active transistor switching output
Signaling battery charge	LED
Signaling battery mode	LED, active transistor switching output
<b>General data</b>	
Storage medium	Lead rechargeable battery module
Weight / Dimensions W x H x D	1 kg / 110 x 90 x 90 mm
Installation position	horizontal DIN rail NS 35, EN 60715
Spacing when mounting	Alignable: 0 mm horizontally, 30 mm vertically
Connection method	Screw connection
Input connection data (solid / stranded / AWG)	0.2 - 2.5 mm <sup>2</sup> / 0.2 - 2.5 mm <sup>2</sup> / 24 - 14
Output connection data (solid / stranded / AWG)	0.2 - 2.5 mm <sup>2</sup> / 0.2 - 2.5 mm <sup>2</sup> / 24 - 14
Signal connection data (solid / stranded / AWG)	0.2 - 2.5 mm <sup>2</sup> / 0.2 - 2.5 mm <sup>2</sup> / 24 - 14
Degree of protection / Protection class	IP20 / III
MTBF (IEC 61709, SN 29500)	> 1400000 h
Ambient temperature (operation)	-15°C ... 50°C
<b>Standards/regulations</b>	
Electromagnetic compatibility	Conformance with EMC Directive 2004/108/EC
Electrical safety, safety transformer	EN 60950-1/VDE 0805 (SELV)
Electronic equipm. for electrical power installations	EN 50178/VDE 0160 (PELV)
UL approvals	UL Listed UL 508, UL/C-UL Recognized UL 60950

**Ordering data**

Description	Type	Order No.	Pcs. / Pkt.
<b>Power supply, uninterruptible</b>	UNO-UPS/24DC/24DC/60W	2905907	1

# Power supplies and UPS

## Uninterruptible power supply units for the control cabinet

### UPS module with integrated power supply unit

#### TRIO UPS

Developed specifically for supplying industrial PCs. Configuration port: freely parameterizable with the UPS CONF configuration software. Configuration stick: parameterize stick once and transfer to any number of TRIO UPS units.

The UPS-CONF TRIO (Order No. 2320348) configuration software can be downloaded free of charge from our homepage.



UPS with integrated power supply,  
100 - 240 V AC / 24 V DC, 5 A

#### Notes:

The buffer time associated with your solution is dependent on the load current. Exact details for each uninterruptible power supply can be found on page 233.

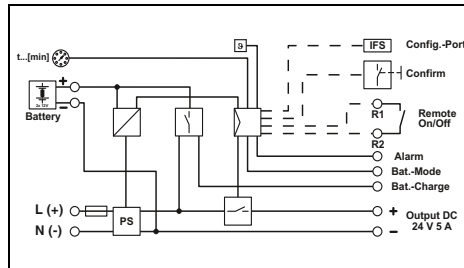

#### Technical data

Input data	
Nominal input voltage range	100 V AC ... 240 V AC
Input voltage range	85 V AC ... 264 V AC / 100 V DC ... 350 V DC
Max. current consumption in normal mode	0.95 A (230 V AC) / 1.1 A (230 V AC, maximum), 1.7 A (120 V AC) / 1.8 A (120 V AC, maximum)
Input fuse	6.3 A (slow-blow, internal)
Reliable backup fuse, circuit breaker	B6, B10, B16
Output data	
Nominal output voltage	24 V DC
Output current	5 A
Can be connected in parallel / series	No / No
Buffer period	20 min (5 A)
Max. power dissipation (normal mode / buffer mode)	16 W / 4 W
Efficiency (typ.)	> 88% (230 V AC, mains operation)
Signaling	
Interfaces	IFS (Interface system data port)
Signaling Power OK	LED
Signaling alarm	LED, active switching output
Signaling battery charge	LED, active switching output
Signaling battery mode	LED, active switching output
General data	
Storage medium	External, battery 1.3 Ah / 3.4 Ah / 7.2 Ah / 12 Ah
Weight / Dimensions W x H x D	1.1 kg / 60 x 130 x 118 mm
Installation position	horizontal DIN rail NS 35, EN 60715
Spacing when mounting	Alignable: horizontally 0 mm, vertically 50 mm
Connection method	Screw connection
Input connection data (solid / stranded / AWG)	0.2 - 2.5 mm <sup>2</sup> / 0.2 - 2.5 mm <sup>2</sup> / 24 - 12
Output connection data (solid / stranded / AWG)	0.2 - 2.5 mm <sup>2</sup> / 0.2 - 2.5 mm <sup>2</sup> / 24 - 12
Signal connection data (solid / stranded / AWG)	0.2 - 2.5 mm <sup>2</sup> / 0.2 - 2.5 mm <sup>2</sup> / 24 - 12
Degree of protection / Protection class	IP20 / I
MTBF (IEC 61709, SN 29500)	> 596000 h (40°C)
Ambient temperature (operation)	-25°C ... 70°C (> 55°C derating: 2.5%/K)
Standards/regulations	
Insulation voltage input/output	2 kV (routine test) / 4 kV (type test)
Electromagnetic compatibility	Conformance with EMC Directive 2004/108/EC
Electrical safety, safety transformer	EN 60950-1/VDE 0805 (SELV)
Electronic equipm. for electrical power installations	EN 50178/VDE 0160 (PELV)
UL approvals	UL/C-UL listed UL 508, UL/C-UL Recognized UL 60950

#### Ordering data

Description	Type	Order No.	Pcs. / Pkt.
Power supply, uninterruptible	TRIO-UPS/1AC/24DC/ 5	2866611	1

Uninterruptible power supply units for the control cabinet

UPS module with integrated power supply unit

MINI-UPS 24 V DC and 12 V DC

The MINI UPS combines the power supply unit and the UPS module in the same housing in a particularly space-saving way.

**Notes:**  
 With the MINI-DC-UPS/12DC/4, buffer times are double those of the MINI-DC-UPS/24DC/2.  
 The buffer time associated with your solution is dependent on the load current. Exact details for each uninterruptible power supply can be found on page 233.



UPS with integrated power supply, 100 - 240 V AC / 24 V DC, 2 A



UPS with integrated power supply, 100 - 240 V AC / 12 V DC, 4 A

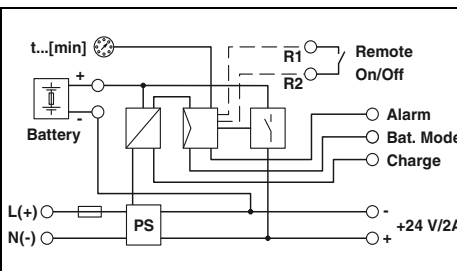

Technical data

Input data	
Nominal input voltage range	100 V AC ... 240 V AC
Input voltage range	85 V AC ... 264 V AC / 100 V DC ... 350 V DC
Max. current consumption in normal mode	0.6 A / 0.85 A (230 V AC), 1.1 A / 1.5 A (120 V AC)
Input fuse	3.15 A (slow-blow, internal)
Reliable backup fuse, circuit breaker	B6, B10, B16
Output data	
Nominal output voltage	24 V DC (AC input voltage available: 22.5 to 29.5 V DC, AC input voltage not available: 27.9 to 19.2 V DC)
Output current	2 A
Can be connected in parallel / series	No / Yes
Buffer period	20 min (2 A)
Max. power dissipation (idling / normal mode / buffer mode)	3.8 W / 10.1 W / 2.1 W
Efficiency (typ.)	> 83%
Signaling	
Signaling Power OK	LED
Signaling alarm	LED, active switching output
Signaling battery charge	LED, active switching output
Signaling battery mode	LED, active switching output
General data	
Storage medium	External, battery 0.8 Ah / 1.3 Ah
Weight / Dimensions W x H x D	0.45 kg / 67.5 x 99 x 107 mm
Installation position	horizontal DIN rail NS 35, EN 60715
Spacing when mounting	Alignable: horizontally 0 mm, vertically 50 mm
Connection method	Plug-in COMBICON screw connections
Input connection data (solid / stranded / AWG)	0.2 - 2.5 mm <sup>2</sup> / 0.2 - 2.5 mm <sup>2</sup> / 24 - 12
Output connection data (solid / stranded / AWG)	0.2 - 2.5 mm <sup>2</sup> / 0.2 - 2.5 mm <sup>2</sup> / 24 - 12
Signal connection data (solid / stranded / AWG)	0.2 - 2.5 mm <sup>2</sup> / 0.2 - 2.5 mm <sup>2</sup> / 24 - 12
Degree of protection / Protection class	IP20 / II
MTBF (IEC 61709, SN 29500)	> 753000 h (40°C)
Ambient temperature (operation)	-25°C ... 70°C (> 60°C derating: 2.5%/K)
Standards/regulations	
Insulation voltage input/output	2 kV (routine test) / 4 kV (type test)
Electromagnetic compatibility	Conformance with EMC Directive 2004/108/EC
Electrical safety, safety transformer	EN 60950-1/VDE 0805 (SELV)
Electronic equipm. for electrical power installations	EN 50178/VDE 0160 (PELV)
UL approvals	UL Listed UL 508, UL/C-UL Recognized UL 60950, UL ANSI/ISA-12.12.01 Class I, Division 2, Groups A, B, C, D (Hazardous Location)

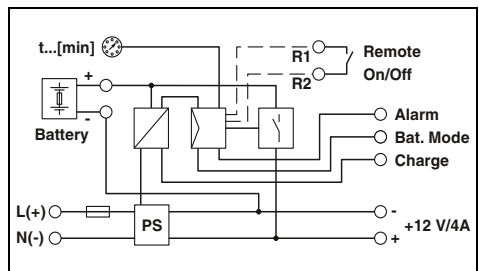

Technical data

Input data	
Nominal input voltage range	100 V AC ... 240 V AC
Input voltage range	85 V AC ... 264 V AC / 100 V DC ... 350 V DC
Max. current consumption in normal mode	0.5 A / 0.65 A (230 V AC), 1.15 A / 1.35 A (120 V AC)
Input fuse	3.15 A (slow-blow, internal)
Reliable backup fuse, circuit breaker	B6, B10, B16
Output data	
Nominal output voltage	12 V DC (AC input voltage available: 10 to 16 V DC, AC input voltage not available: 13.6 to 9.6 V DC)
Output current	4 A
Can be connected in parallel / series	No / Yes
Buffer period	20 min (4 A)
Max. power dissipation (idling / normal mode / buffer mode)	1.6 W / 10.5 W / 2.6 W
Efficiency (typ.)	> 82%
Signaling	
Signaling Power OK	LED
Signaling alarm	LED, active switching output
Signaling battery charge	LED, active switching output
Signaling battery mode	LED, active switching output
General data	
Storage medium	External, rechargeable battery 1.6 Ah / 2.6 Ah
Weight / Dimensions W x H x D	0.45 kg / 67.5 x 99 x 107 mm
Installation position	horizontal DIN rail NS 35, EN 60715
Spacing when mounting	Alignable: horizontally 0 mm, vertically 50 mm
Connection method	Plug-in COMBICON screw connections
Input connection data (solid / stranded / AWG)	0.2 - 2.5 mm <sup>2</sup> / 0.2 - 2.5 mm <sup>2</sup> / 24 - 12
Output connection data (solid / stranded / AWG)	0.2 - 2.5 mm <sup>2</sup> / 0.2 - 2.5 mm <sup>2</sup> / 24 - 12
Signal connection data (solid / stranded / AWG)	0.2 - 2.5 mm <sup>2</sup> / 0.2 - 2.5 mm <sup>2</sup> / 24 - 12
Degree of protection / Protection class	IP20 / II
MTBF (IEC 61709, SN 29500)	> 728000 h (40°C)
Ambient temperature (operation)	-25°C ... 70°C (> 60°C derating: 2.5%/K)
Standards/regulations	
Insulation voltage input/output	2 kV (routine test) / 4 kV (type test)
Electromagnetic compatibility	Conformance with EMC Directive 2004/108/EC
Electrical safety, safety transformer	EN 60950-1/VDE 0805 (SELV)
Electronic equipm. for electrical power installations	EN 50178/VDE 0160 (PELV)
UL approvals	UL Listed UL 508, UL/C-UL Recognized UL 60950, UL ANSI/ISA-12.12.01 Class I, Division 2, Groups A, B, C, D (Hazardous Location)

Ordering data

Description	Type	Order No.	Pcs. / Pkt.
Power supply, uninterruptible	MINI-DC-UPS/24DC/2	2866640	1

Ordering data

Description	Type	Order No.	Pcs. / Pkt.
Power supply, uninterruptible	MINI-DC-UPS/12DC/4	2866598	1

# Power supplies and UPS

## Uninterruptible power supply units for the control cabinet

### Power storage for TRIO UPS

#### MINI-BAT, QUINT-BAT

MINI-BAT and QUINT BAT for maximum buffer times

- Lead AGM (Absorbent Glass Mat) technology
- Ambient temperatures from 0 to +40°C

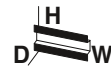

Power storage, 24 V DC, 1.3 Ah for TRIO UPS and MINI UPS 2 A

ERC  
Ex:

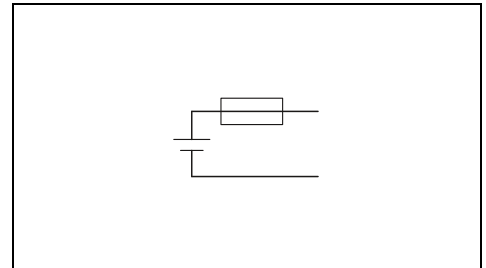

Technical data			
Input data/output data			
Nominal capacity	1.3 Ah		
Nominal output voltage	24 V DC		
Output current	15 A		
Can be connected in parallel / series	Yes / No		
General data			
Weight / Dimensions W x H x D	1.7 kg / 52 x 130 x 110 mm		
Degree of protection / Protection class	IP20 / III		
Ambient temperature (operation)	0°C ... 40°C		
Service life	6 years ... 9 years (20°C)		
Latest startup	6 months (20°C ... 30°C) 3 months (30°C ... 40°C)		
Ordering data			
Description	Type	Order No.	Pcs. / Pkt.
Power storage	MINI-BAT/24DC/1.3AH	2866417	1





Power storage, 24 V DC, 3.4 Ah  
for TRIO UPS



Power storage, 24 V DC, 7.2 Ah  
for TRIO UPS



Power storage, 24 V DC, 12 Ah  
for TRIO UPS

BSH

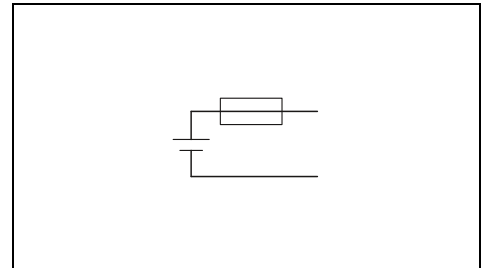
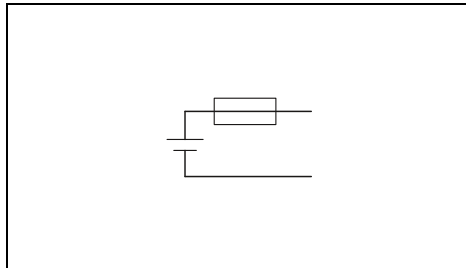
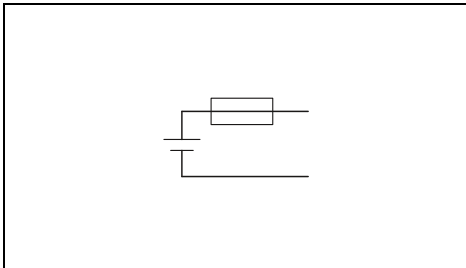

Technical data

3.4 Ah  
24 V DC  
25 A  
Yes / No

3.5 kg / 112 x 145 x 123 mm  
IP20 / -  
0°C ... 40°C  
6 years ... 9 years (20°C)  
9 months (20°C ... 30°C)  
6 months (30°C ... 40°C)

Technical data

7.2 Ah  
24 V DC  
50 A  
Yes / No

6 kg / 164 x 156 x 110 mm  
IP20 / III  
0°C ... 40°C  
6 years ... 9 years (20°C)  
9 months (20°C ... 30°C)  
6 months (30°C ... 40°C)

Technical data

12 Ah  
24 V DC  
50 A  
Yes / No

9 kg / 231 x 156 x 110 mm  
IP20 / III  
0°C ... 40°C  
6 years ... 9 years (20°C)  
9 months (20°C ... 30°C)  
6 months (30°C ... 40°C)

Ordering data

Type	Order No.	Pcs. / Pkt.
QUINT-BAT/24DC/ 3.4AH	2866349	1

Ordering data

Type	Order No.	Pcs. / Pkt.
QUINT-BAT/24DC/ 7.2AH	2866352	1

Ordering data

Type	Order No.	Pcs. / Pkt.
QUINT-BAT/24DC/12AH	2866365	1

# Power supplies and UPS

## Uninterruptible power supply units for the control cabinet

### Power storage for MINI UPS

#### MINI-BAT

- MINI-BAT for maximum buffer times
- Lead AGM (Absorbent Glass Mat) technology
- Ambient temperatures from 0 to +40°C

**Notes:**  
The buffer time associated with your solution is dependent on the load current. Exact details for each uninterruptible power supply can be found on page 233.



**Power storage, 24 V DC, 0.8 Ah for MINI UPS 2 A**

ERC  
Ex:

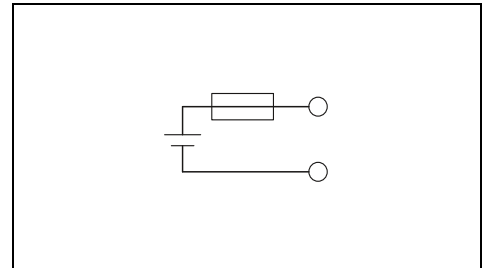

Input data/output data	
Nominal capacity	0.8 Ah
Nominal output voltage	24 V DC
Output current	5 A
Can be connected in parallel / series	Yes / No
General data	
Weight / Dimensions W x H x D	0.9 kg / 67.5 x 99 x 107 mm
Degree of protection / Protection class	IP20 / III
Ambient temperature (operation)	0°C ... 40°C
Service life	4 years (20°C)
Latest startup	6 months (20°C ... 30°C) 3 months (30°C ... 40°C)

### Technical data

Nominal capacity	0.8 Ah
Nominal output voltage	24 V DC
Output current	5 A
Can be connected in parallel / series	Yes / No
General data	
Weight / Dimensions W x H x D	0.9 kg / 67.5 x 99 x 107 mm
Degree of protection / Protection class	IP20 / III
Ambient temperature (operation)	0°C ... 40°C
Service life	4 years (20°C)
Latest startup	6 months (20°C ... 30°C) 3 months (30°C ... 40°C)

Description
<b>Power storage</b>

Ordering data		
Type	Order No.	Pcs. / Pkt.
MINI-BAT/24DC/0.8AH	2866666	1



Power storage, 24 V DC, 1.3 Ah  
for TRIO UPS and MINI UPS 2 A

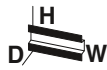

Power storage 12 V DC, 1.6 Ah  
for MINI UPS 4 A



Power storage 12 V DC, 2.6 Ah  
for MINI UPS 4 A

ERC  
Ex:

ERC  
Ex:

ERC  
Ex:

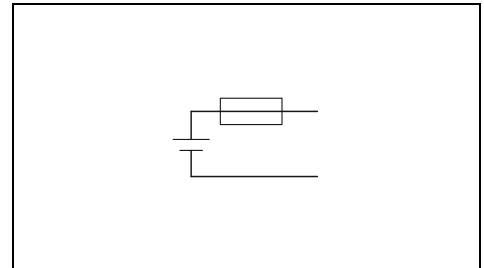
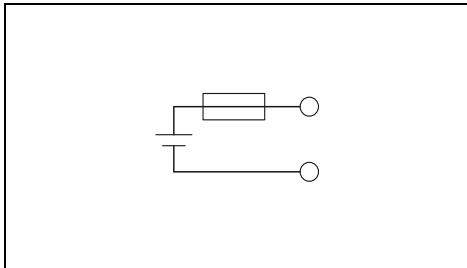
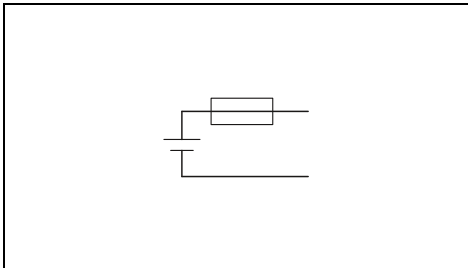

Technical data

1.3 Ah  
24 V DC  
15 A  
Yes / No

1.7 kg / 52 x 130 x 110 mm  
IP20 / III  
0°C ... 40°C  
6 years ... 9 years (20°C)  
6 months (20°C ... 30°C)  
3 months (30°C ... 40°C)

Technical data

1.6 Ah  
12 V DC  
10 A  
Yes / No

0.9 kg / 67.5 x 99 x 107 mm  
IP20 / III  
0°C ... 40°C  
4 years (20°C)  
6 months (20°C ... 30°C)  
3 months (30°C ... 40°C)

Technical data

2.6 Ah  
12 V DC  
15 A  
Yes / No

1.7 kg / 52 x 130 x 110 mm  
IP20 / III  
0°C ... 40°C  
6 years ... 9 years (20°C)  
6 months (20°C ... 30°C)  
3 months (30°C ... 40°C)

Ordering data

Type	Order No.	Pcs. / Pkt.
MINI-BAT/24DC/1.3AH	2866417	1

Ordering data

Type	Order No.	Pcs. / Pkt.
MINI-BAT/12DC/1.6AH	2866572	1

Ordering data

Type	Order No.	Pcs. / Pkt.
MINI-BAT/12DC/2.6AH	2866569	1



### Constant power supply and improved power quality

UPS devices play an important role in ensuring reliable power quality. They bridge power failures and remove other mains faults such as:

- Undervoltages or surge voltages
- High-frequency noise
- Frequency fluctuations
- Harmonics

### Class VFI-SS-111 UPS devices according to IEC 62040-3

The UPS devices are class VFI-SS-111 single-phase, uninterruptible power supply units. The connected loads are protected against any faults on the mains side. Double conversion technology permanently supplies loads with an output voltage/frequency that is independent of the mains input.

### Extensive configuration options:

Configure your UPS system according to your requirements and the operating environment.

UPS-CP devices can be configured directly via the control panel, even with no external power supply, provided the batteries are charged:

- Quick status check via LED and illuminated LCD control panel
  - Controlled computer shutdown by means of additional software
  - Remote access via web browser with SNMP network card
- Complete and extend your UPS system:
- DIN rails offer the option of installing the UPS-CP devices in 19" racks
  - All devices can be extended with SNMP network cards or relay cards

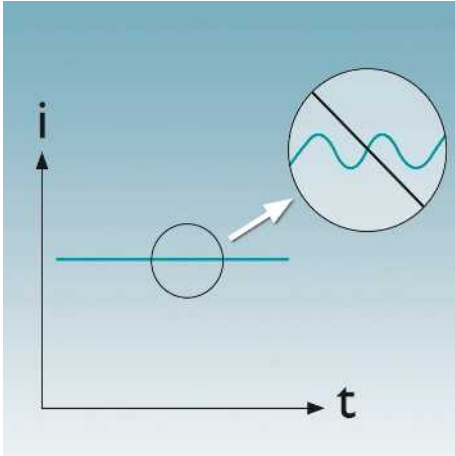

**Long battery life**

The special charge control of the UPS-CP devices ensures ripple-free DC voltage without higher-level AC currents.



**Integrated safety cut-off**

If required the UPS-CP devices can be integrated in a safety concept via a two-pos. connection.



**Easy battery replacement**

Batteries can be easily replaced during operation and when integrated. This is true for all UPS devices and battery modules.



**Stand-alone or 19" rack installation possible**

Depending on the application, the control panel on the UPS-CP devices can be rotated 90° for optimum display clarity.

**Find out more with the web code**

Detailed information on these products can be found on our website.

#0155

**Search**

Simply enter # and numbers in the search field.





# Protective devices

## High-quality device circuit breakers provide optimum system protection

Thermomagnetic and electronic device circuit breakers are a key factor in maximizing system availability. In the event of overload and short-circuit currents, they selectively shut down the faulty circuit.

 Your web code: [#0156](#)

<b>Introduction</b>	<b>248</b>
<hr/>	
<b>Selection guide</b>	<b>250</b>
<hr/>	
<b>CB series device circuit breakers</b>	
Base elements and jumpers	<b>252</b>
Thermomagnetic circuit breakers	<b>253</b>
Electronic circuit breakers	<b>256</b>
Multi-channel, electronic circuit breakers - CBM	<b>258</b>
Device circuit breaker boards - CBB	<b>259</b>
Applications	<b>260</b>
<hr/>	
<b>Device circuit breakers</b>	
Thermal circuit breakers - TCP	<b>262</b>
Thermomagnetic circuit breakers - TMC	<b>264</b>
Electronic device circuit breakers	<b>266</b>



### Branch out

The device circuit breakers provide reliable protection even in systems with long cable paths. Together with the SFB technology\* of the QUINT POWER power supplies, the special SFB tripping characteristic of the CB device circuit breakers ensures fast shutdown in the event of an error. This combination offers maximum protection against overload and short-circuit currents.

\*SFB - selective fuse breaking, selective shutdown

### Individual adaptation

Systems and control cabinets can be pre-wired with base elements and individually fitted with corresponding protective plugs on site. Should the demands on a load change in the meantime, you can simply replace the protective plug in question. Various tripping methods, tripping characteristics, and nominal currents are available depending on the application.

### Modular extension

It couldn't be easier. A system can be extended with additional device circuit breakers in no time at all. You can bridge the power distribution, remote signaling or even the auxiliary voltage for electronic circuit breakers without this resulting in significant wiring costs. The uniform, plug-in housing concept as well as the bridgeability of the base elements simplify installation.

### Multi-channel, electronic circuit breakers - CBM

The CBM multi-channel electronic device circuit breakers provide fast, space-saving, and reliable protection against overload and short-circuit currents. Push-in connection technology enables quick and tool-free installation. Errors in the system are detected quickly, thanks to the 80% advance warning. Electronic locking of the current values prevents inadvertent changes being made to the settings.

### Device circuit breaker boards

The multi-channel device circuit breaker boards are used in machine building or in control and process technology, for example. Due to the central potential distribution, installation time is reduced to a minimum, while simultaneously saving space compared to conventional installations. The board can be integrated into safety concepts via a relay contact.





**Latching**

The new locking mechanism ensures a secure hold in harsh environments and where there are vibrations in the installation environment. It holds the plug securely in the base element. The plugs can be removed from the base element quickly and easily by simply applying light pressure to the locking mechanism.

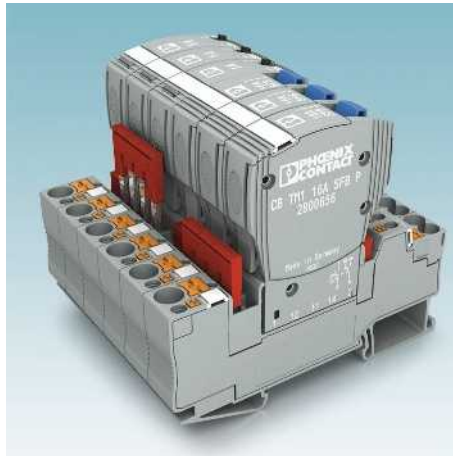

**Bridge**

With the unique bridge system from our standard range, the device circuit breakers can be combined easily as per your requirements. Potentials of the same type can be connected quickly and safely.



**Variable connection technologies**

Base elements are available with conventional screw connection technology or quick-to-wire push-in connection technology.

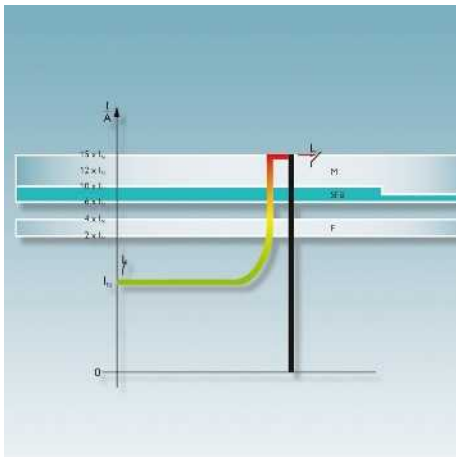

**SFB tripping characteristic**

Thermomagnetic device circuit breakers with the SFB tripping characteristic\* provide maximum overcurrent protection – even in large systems with long cable paths.



**Multi-channel, electronic circuit breakers - CBM**

Four or eight circuits are protected against overload and short-circuit currents over a width of just 41 mm. Thanks to adjustable nominal currents of 0.5 to 10 A in a single device, storage costs are reduced while simultaneously increasing flexibility for system planning.



**Device circuit breaker boards - CBB**

The multi-channel device circuit breaker boards are available with 4, 8 or 12 channels. The boards are very versatile as they can be fitted individually with thermomagnetic or electronic circuit breakers.



# Protective devices

## Selection guide

The selection matrix shows the different functions of different circuit breaker types.

Note:

A corresponding base element is essential for the operation of the plug-in device circuit breakers. For more information, see the accessories section under device circuit breakers.

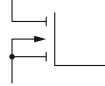
Technology		Tripping characteristics	Status indicator
Thermal 	TCP	Thermal	Switch position
	TCP/DC	Thermal	Switch position
Thermomagnetic 	TMC	F1	Switch position
		M1	Switch position
	UT6/TMC	M1	Switch position
	TMCP	F1	Switch position
		M1	Switch position
	CB TM1	F1	Switch position
		M1	Switch position
		SFB	Switch position
Electronic 	EC-E	Electronic	LED, Switch position
	ECP	Electronic	LED, Switch position
	ECP-E	Electronic	LED, Switch position
	CB-E1	Electronic	LED, Switch position
Multi-channel, electronic	CBM	Electronic	LED
Circuit breaker board	CBB	F1, M1, SFB, and electronic	Switch position or LED

Number of channels							Remote signaling	Reset input	Plug-in	Connection	Order No.	Page
1	2	3	4	8	12							
✓									✓	Screw, spring-cage	E.g., <a href="#">0712123</a>	263
✓									✓	Screw, spring-cage	E.g., <a href="#">0700005</a>	262
✓	✓	✓					✓			Screw	E.g., <a href="#">0914015</a>	265
✓	✓						✓			Screw	E.g., <a href="#">0914374</a>	265
✓										Screw	E.g., <a href="#">0916603</a>	264
✓	✓	✓					✓		✓	Spring-cage	E.g., <a href="#">0915506</a>	265
✓	✓	✓					✓		✓	Spring-cage	E.g., <a href="#">0915687</a>	265
✓	✓						✓		✓	Screw, push-in, solder connection	E.g., <a href="#">2800857</a>	254
✓	✓						✓		✓	Screw, push-in, solder connection	E.g., <a href="#">2800846</a>	254
✓	✓						✓		✓	Screw, push-in, solder connection	E.g., <a href="#">2800835</a>	253
✓							✓	✓		Screw	E.g., <a href="#">0903041</a>	268
✓							✓		✓	Spring-cage	E.g., <a href="#">0911034</a>	266
✓							✓	✓	✓	Spring-cage	E.g., <a href="#">0900113</a>	266
✓							✓	✓	✓	Screw, push-in, solder connection	E.g., <a href="#">2800901</a>	256
			✓	✓			✓	✓		Push-in	E.g., <a href="#">2905743</a>	258
			✓	✓	✓		✓		✓	Push-in	E.g., <a href="#">2905238</a>	259

# Protective devices

## CB series device circuit breakers

### Base elements and jumpers

#### Base elements

- For accommodating CB TM.../CB E... device circuit breakers
- DIN rail module
- With bridge shafts
- Systematic structure with 1-channel base elements possible

**Notes:**  
Can be loaded with up to 41 A if two jumpers are connected for the supply.

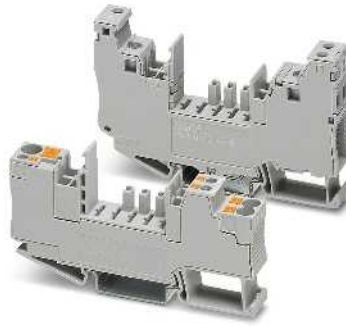

1-pos, with screw or push-in connection technology



For the PCB

	Technical data			Technical data		
Electrical data	... PT-BE	... UT-BE				
Rated surge voltage	4 kV	2.5 kV				-
<b>General data</b>						
Dimensions W / H / D	12.3 mm / 90 mm / 46.7 mm	12.3 mm / 90.8 mm / 70 mm		12.3 mm / 34.8 mm / 36.4 mm		
Connection method	Push-in connection	Screw connection		Solder connection		
Ambient temperature (operation)	-30°C ... 60°C	-30°C ... 60°C		-30°C ... 60°C		
Degree of protection	IP30 (actuation area)	IP30 (actuation area)		IP30 (plug-in area with plugged-in device) / IP00 (connection area)		
Inflammability class according to UL 94	V0	V0		V-0		
Standards/regulations	IEC 60947-7-1	UL 1059		DIN EN 50155 / IEC 60068-2		
	Ordering data			Ordering data		
Description	Type	Order No.	Pcs. / Pkt.	Type	Order No.	Pcs. / Pkt.
<b>Base element</b>						
For the PCB	CB 1/6-2/4 PT-BE	2800929	10	CB S-BE	2905067	30
	CB 1/10-1/10 UT-BE	2801305	10			
	Accessories			Accessories		
<b>Jumper, red</b>	Number of positions	FBS 2-6	3030336	50		
	2	FBS 3-6	3030242	50		
	3	FBS 4-6	3030255	50		
	4	FBS 5-6	3030349	50		
	5	FBS 10-6	3030271	10		
	10	FBS 20-6	3030365	10		
	20	FBS 50-6	3032224	10		
	50					
<b>Jumper, blue</b>	Number of positions	FBS 2-6 BU	3036932	50		
	2	FBS 3-6 BU	3036945	50		
	3	FBS 4-6 BU	3036958	50		
	4	FBS 5-6 BU	3036961	50		
	5	FBS 10-6 BU	3032198	10		
	10	FBS 20-6 BU	3032208	10		
	20	FBS 50-6 BU	3032211	10		
	50					
<b>Jumper, gray</b>	Number of positions	FBS 2-6 GY	3032237	50		
	2	FBS 3-6 GY	3032240	50		
	3	FBS 4-6 GY	3032279	50		
	4	FBS 5-6 GY	3032266	50		
	5	FBS 10-6 GY	3032253	10		
	10					

**Plug-in thermomagnetic circuit breakers**

- Device circuit breakers for protecting against voltage dips caused by overloads and short circuits
- SFB characteristic curve enables longer cables and release times < 10 ms
- Maximum ease of maintenance, thanks to the two-piece design
- Snap-in function for secure hold and easy removal
- Plug coding possible
- Slim design

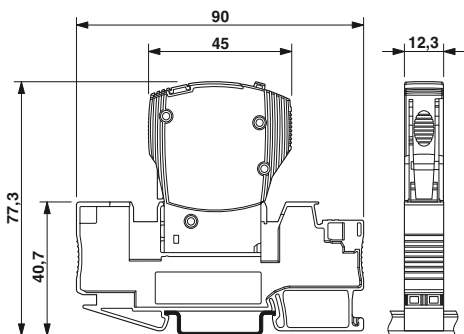

The figure shows the complete module consisting of a base element and plug



Plug-in, SFB characteristic curve

UL US ENEC CE  
Total width 12.3 mm

Rated data	
Rated voltage	50 V DC
Nominal current $I_N$	0.5 A to 16 A
Disconnection	
Shutdown time	< 10 ms
Fuse type	SFB
Rated short-circuit switching capacity $I_{cn}$	- / 600 A (50 V DC)
Cycles, max.	6000 (at 1 x $I_n$ )
General data	
Ambient temperature (operation)	-30°C ... 60°C
Degree of protection	IP30 (actuation area)
Standards/regulations	EN 60934 / UL 1077 / UL 508 / CSA 22.2

Technical data		
IEC	UL / CUL	CSA
50 V DC	50 V DC	-
Depends on the product version selected		
See tripping characteristic		
SFB		
- / 600 A (50 V DC)		
6000 (at 1 x $I_n$ )		
-30°C ... 60°C		
IP30 (actuation area)		
EN 60934 / UL 1077 / UL 508 / CSA 22.2		

Description	Nominal current
<b>Thermomagnetic circuit breaker, plug-in, 1-pos., signal contact 1 PDT</b>	0.5 A
	1 A
	2 A
	3 A
	4 A
	5 A
	6 A
	8 A
	10 A
	12 A
	16 A
<b>Thermomagnetic circuit breaker, plug-in, 2-pos., signal contact 1 PDT</b>	0.5 A
	1 A
	2 A
	3 A
	4 A
	5 A
	6 A
	8 A
	10 A
	12 A
	16 A

Ordering data		
Type	Order No.	Pcs. / Pkt.
CB TM1 0.5A SFB P	2800835	1
CB TM1 1A SFB P	2800836	1
CB TM1 2A SFB P	2800837	1
CB TM1 3A SFB P	2800838	1
CB TM1 4A SFB P	2800839	1
CB TM1 5A SFB P	2800840	1
CB TM1 6A SFB P	2800841	1
CB TM1 8A SFB P	2800842	1
CB TM1 10A SFB P	2800843	1
CB TM1 12A SFB P	2800844	1
CB TM1 16A SFB P	2800845	1
CB TM2 0.5A SFB P	2800868	1
CB TM2 1A SFB P	2800869	1
CB TM2 2A SFB P	2800870	1
CB TM2 3A SFB P	2800871	1
CB TM2 4A SFB P	2800872	1
CB TM2 5A SFB P	2800873	1
CB TM2 6A SFB P	2800874	1
CB TM2 8A SFB P	2800875	1
CB TM2 10A SFB P	2800876	1
CB TM2 12A SFB P	2800877	1
CB TM2 16A SFB P	2800878	1

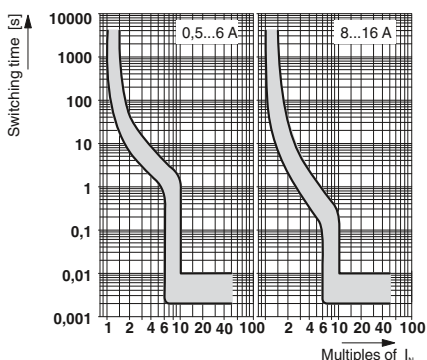

Tripping characteristic in the DC range

Bridge plug, 0 volt distribution	
<b>Base element</b>	
With push-in connection technology	
With screw connection technology	
For the PCB	

Accessories		
CB PT BRIDGE	2801014	1
CB 1/6-2/4 PT-BE	2800929	10
CB 1/10-1/10 UT-BE	2801305	10
CB S-BE	2905067	30

# Protective devices

## CB series device circuit breakers

### Plug-in thermomagnetic circuit breakers

- Device circuit breakers for protecting against voltage dips caused by overloads and short circuits
- Medium-blow and fast-blow tripping characteristics
- 1 and 2-pos. circuit breakers
- Maximum ease of maintenance, thanks to the two-piece design
- Snap-in function for secure hold and easy removal
- Plug coding possible
- Slim design

**Notes:**  
When used in conjunction with order numbers 2800929 and 2801305, the items also satisfy UL 508.

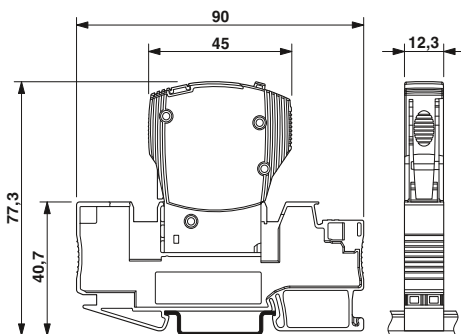

The figure shows the complete module consisting of a base element and plug



Plug-in, M1 characteristic curve, 1-pos.

UL, IEC, ENEC, ERE, UL, CE  
Total width 12.3 mm

#### Technical data

IEC	UL / CUL	CSA
240 V AC	277 V AC	-
50 V DC	50 V DC	-
Depends on the product version selected		
See tripping characteristic normal blow		
300 A (240 V AC) / 600 A (50 V DC)		
6000 (at 1 x I <sub>n</sub> )		
-30°C ... 60°C		
IP30 (actuation area)		
EN 60934 / UL 1077 / UL 508 / CSA 22.2		

#### Ordering data

Description	Nominal current	Type	Order No.	Pcs. / Pkt.
<b>Thermomagnetic circuit breaker, plug-in, signal contact 1 PDT</b>				
	0.5 A	CB TM1 0.5A M1 P	2800846	1
	1 A	CB TM1 1A M1 P	2800847	1
	2 A	CB TM1 2A M1 P	2800848	1
	3 A	CB TM1 3A M1 P	2800849	1
	4 A	CB TM1 4A M1 P	2800850	1
	5 A	CB TM1 5A M1 P	2800851	1
	6 A	CB TM1 6A M1 P	2800852	1
	8 A	CB TM1 8A M1 P	2800853	1
	10 A	CB TM1 10A M1 P	2800854	1
	12 A	CB TM1 12A M1 P	2800855	1
	16 A	CB TM1 16A M1 P	2800856	1

#### Accessories

Description	Order No.	Pcs. / Pkt.
<b>Bridge plug, 0 volt distribution</b>		
CB PT BRIDGE	2801014	1
CB 1/6-2/4 PT-BE	2800929	10
CB 1/10-1/10 UT-BE	2801305	10
CB S-BE	2905067	30

**Base element**  
With push-in connection technology  
With screw connection technology  
For the PCB

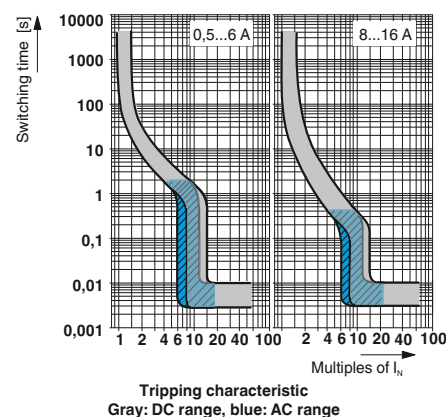



Plug-in, M1 characteristic curve, 2-pos.



Plug-in, F1 characteristic curve, 1-pos.



Plug-in, F1 characteristic curve, 2-pos.

UL ENE EAC  
Total width 24.6 mm

UL ENE EAC  
Total width 12.3 mm

UL ENE EAC  
Total width 24.6 mm

Technical data		
IEC	UL / CUL	CSA
240 V AC	277 V AC	-
80 V DC	80 V DC	-
Depends on the product version selected		
See tripping characteristic normal blow		
400 A (240 V AC) / 600 A (80 V DC)		
6000 (240 V AC/1 x I <sub>n</sub> )		
-30°C ... 60°C		
IP30 (actuation area)		
EN 60934 / UL 1077 / UL 508 / CSA 22.2		

Technical data		
IEC	UL / CUL	CSA
-	-	-
50 V DC	50 V DC	-
Depends on the product version selected		
See tripping characteristic fast blow		
- / 600 A (50 V DC)		
6000 (at 1 x I <sub>n</sub> )		
-30°C ... 60°C		
IP30 (actuation area)		
EN 60934 / UL 1077 / UL 508 / CSA 22.2		

Technical data		
IEC	UL / CUL	CSA
-	-	-
80 V DC	80 V DC	-
Depends on the product version selected		
See tripping characteristic fast blow		
- / 600 A (80 V DC)		
6000 (240 V AC/1 x I <sub>n</sub> )		
-30°C ... 60°C		
IP30 (actuation area)		
EN 60934 / UL 1077 / UL 508 / CSA 22.2		

Ordering data		
Type	Order No.	Pcs. / Pkt.
CB TM2 0.5A M1 P	2800879	1
CB TM2 1A M1 P	2800880	1
CB TM2 2A M1 P	2800881	1
CB TM2 3A M1 P	2800882	1
CB TM2 4A M1 P	2800883	1
CB TM2 5A M1 P	2800884	1
CB TM2 6A M1 P	2800885	1
CB TM2 8A M1 P	2800886	1
CB TM2 10A M1 P	2800887	1
CB TM2 12A M1 P	2800888	1
CB TM2 16A M1 P	2800889	1

Ordering data		
Type	Order No.	Pcs. / Pkt.
CB TM1 0.5A F1 P	2800857	1
CB TM1 1A F1 P	2800858	1
CB TM1 2A F1 P	2800859	1
CB TM1 3A F1 P	2800860	1
CB TM1 4A F1 P	2800861	1
CB TM1 5A F1 P	2800862	1
CB TM1 6A F1 P	2800863	1
CB TM1 8A F1 P	2800864	1
CB TM1 10A F1 P	2800865	1
CB TM1 12A F1 P	2800866	1
CB TM1 16A F1 P	2800867	1

Ordering data		
Type	Order No.	Pcs. / Pkt.
CB TM2 0.5A F1 P	2800890	1
CB TM2 1A F1 P	2800891	1
CB TM2 2A F1 P	2800892	1
CB TM2 3A F1 P	2800893	1
CB TM2 4A F1 P	2800894	1
CB TM2 5A F1 P	2800895	1
CB TM2 6A F1 P	2800896	1
CB TM2 8A F1 P	2800897	1
CB TM2 10A F1 P	2800898	1
CB TM2 12A F1 P	2800899	1
CB TM2 16A F1 P	2800900	1

Accessories		
CB PT BRIDGE	2801014	1
CB 1/6-2/4 PT-BE	2800929	10
CB 1/10-1/10 UT-BE	2801305	10
CB S-BE	2905067	30

Accessories		
CB PT BRIDGE	2801014	1
CB 1/6-2/4 PT-BE	2800929	10
CB 1/10-1/10 UT-BE	2801305	10
CB S-BE	2905067	30

Accessories		
CB PT BRIDGE	2801014	1
CB 1/6-2/4 PT-BE	2800929	10
CB 1/10-1/10 UT-BE	2801305	10
CB S-BE	2905067	30

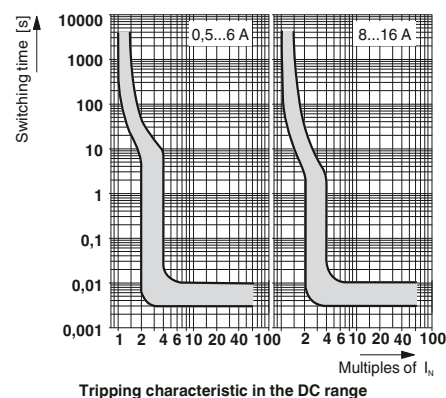
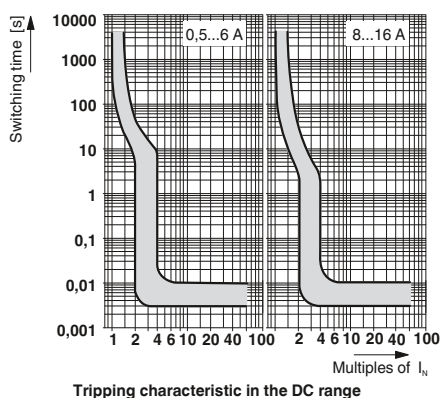
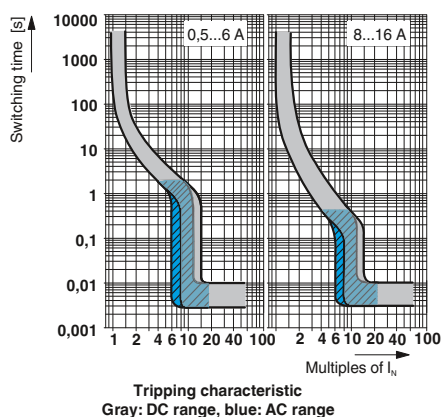

# Protective devices

## CB series device circuit breakers

### Plug-in electronic circuit breakers

- Device circuit breakers for protecting against voltage dips caused by overloads and short circuits
- Integrated active current limitation
- Remote control possible
- Maximum ease of maintenance, thanks to the two-piece design
- Snap-in function for secure hold and easy removal
- Plug coding possible
- Slim design

**Notes:**  
When used in conjunction with order numbers 2800929 and 2801305, the items also satisfy UL 508.

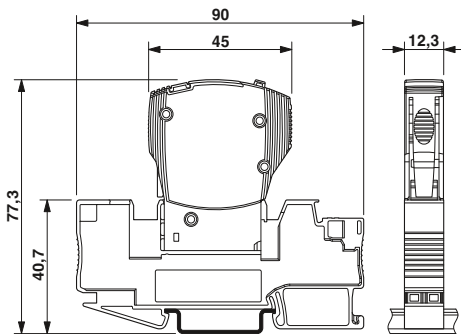

The figure shows the complete module consisting of a base element and plug



1 N/O contact

UL ENEC VDE  
Total width 12.3 mm

#### Technical data

24 V DC  
Depends on the product version selected

See tripping characteristic  
typ. 1.25 x I<sub>N</sub>

-25°C ... 50°C (non-condensing)  
IP30 (actuation area)  
UL 2367 / UL 508 / EN 61000-6-3 / EN 61000-6-2

#### Ordering data

Description	Nominal current
Electronic circuit breaker, 1-pos.	1 A
	2 A
	3 A
	4 A
	6 A
	8 A
	10 A
Electronic circuit breaker, 1-pos., status output inverted	1 A
	2 A
	3 A
	4 A
	6 A
	8 A
	10 A

Type	Order No.	Pcs. / Pkt.
CB E1 24DC/1A NO P	2800901	1
CB E1 24DC/2A NO P	2800902	1
CB E1 24DC/3A NO P	2800903	1
CB E1 24DC/4A NO P	2800904	1
CB E1 24DC/6A NO P	2800905	1

**Bridge plug, 0 volt distribution**

**Base element**  
With push-in connection technology  
With screw connection technology  
For the PCB

#### Accessories

Accessories	Order No.	Pcs. / Pkt.
CB PT BRIDGE	2801014	1
CB 1/6-2/4 PT-BE	2800929	10
CB 1/10-1/10 UT-BE	2801305	10
CB S-BE	2905067	30

**Jumper, for cross connections in the bridge shaft**

For FBS ..., see page 252

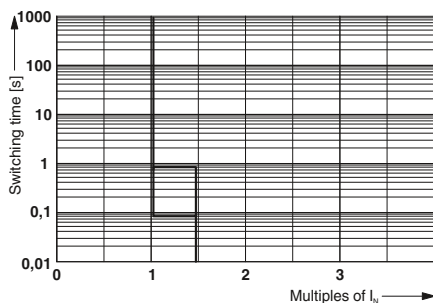

Tripping characteristic





1 N/C contact



1 x Status OUT + 1 x Reset IN



1 x Status OUT + 1 x Control IN

Total width 12.3 mm

Total width 12.3 mm

Total width 12.3 mm

Technical data	
24 V DC	
Depends on the product version selected	
See tripping characteristic typ. 1.25 x I <sub>N</sub>	
-25°C ... 50°C (non-condensing)	
IP30 (actuation area)	
UL 2367 / UL 508 / EN 61000-6-3 / EN 61000-6-2	

Technical data	
24 V DC	
Depends on the product version selected	
See tripping characteristic typ. 1.25 x I <sub>N</sub>	
-25°C ... 50°C (non-condensing)	
IP30 (actuation area)	
UL 2367 / UL 508 / EN 61000-6-3 / EN 61000-6-2	

Technical data	
24 V DC	
Depends on the product version selected	
See tripping characteristic typ. 1.25 x I <sub>N</sub>	
-25°C ... 50°C (non-condensing)	
IP30 (actuation area)	
UL 2367 / UL 508 / EN 61000-6-3 / EN 61000-6-2	

Ordering data		
Type	Order No.	Pcs. / Pkt.
CB E1 24DC/1A NC P	2800915	1
CB E1 24DC/2A NC P	2800916	1
CB E1 24DC/3A NC P	2800917	1
CB E1 24DC/4A NC P	2800918	1
CB E1 24DC/6A NC P	2800919	1

Ordering data		
Type	Order No.	Pcs. / Pkt.
CB E1 24DC/1A S-R P	2800908	1
CB E1 24DC/2A S-R P	2800909	1
CB E1 24DC/3A S-R P	2800910	1
CB E1 24DC/4A S-R P	2800911	1
CB E1 24DC/6A S-R P	2800912	1
CB E1 24DC/8A S-R P	2800913	1
CB E1 24DC/10A S-R P	2800914	1
CB E1 24DC/1A SI-R P	2905799	1
CB E1 24DC/2A SI-R P	2905800	1
CB E1 24DC/3A SI-R P	2905801	1
CB E1 24DC/4A SI-R P	2905802	1
CB E1 24DC/6A SI-R P	2905803	1
CB E1 24DC/8A SI-R P	2905804	1
CB E1 24DC/10A SI-R P	2905805	1

Ordering data		
Type	Order No.	Pcs. / Pkt.
CB E1 24DC/1A S-C P	2800922	1
CB E1 24DC/2A S-C P	2800923	1
CB E1 24DC/3A S-C P	2800924	1
CB E1 24DC/4A S-C P	2800925	1
CB E1 24DC/6A S-C P	2800926	1
CB E1 24DC/8A S-C P	2800927	1
CB E1 24DC/10A S-C P	2800928	1
CB E1 24DC/1A SI-C P	2905806	1
CB E1 24DC/2A SI-C P	2905807	1
CB E1 24DC/3A SI-C P	2905808	1
CB E1 24DC/4A SI-C P	2905809	1
CB E1 24DC/6A SI-C P	2905810	1
CB E1 24DC/8A SI-C P	2905811	1
CB E1 24DC/10A SI-C P	2905812	1

Accessories		
Type	Order No.	Pcs. / Pkt.
CB PT BRIDGE	2801014	1
CB 1/6-2/4 PT-BE	2800929	10
CB 1/10-1/10 UT-BE	2801305	10
CB S-BE	2905067	30

Accessories		
Type	Order No.	Pcs. / Pkt.
CB PT BRIDGE	2801014	1
CB 1/6-2/4 PT-BE	2800929	10
CB 1/10-1/10 UT-BE	2801305	10
CB S-BE	2905067	30

Accessories		
Type	Order No.	Pcs. / Pkt.
CB PT BRIDGE	2801014	1
CB 1/6-2/4 PT-BE	2800929	10
CB 1/10-1/10 UT-BE	2801305	10
CB S-BE	2905067	30

For FBS ..., see page 252

For FBS ..., see page 252

For FBS ..., see page 252

# Protective devices

## CB series device circuit breakers

### Multi-channel electronic device circuit breakers

- For protection against voltage dips caused by overload and short circuit
- Adjustable from 0.5 - 10 A
- Integrated dynamic current limitation
- Supply up to 80 A possible
- Slim design



new

DIN-rail-mountable,  
4-channel



new

DIN-rail-mountable,  
8-channel

	Technical data	Technical data
<b>Rated data</b>		
Rated voltage	24 V DC	24 V DC
Rated current $I_N$	max. 40 A DC	max. 80 A DC (for double supply IN+ with at least 2 x 6 mm <sup>2</sup> )
Rated current $I_N$	0.5 / 1 / 2 / 4 / 6 / 10 A DC (adjustable per output channel)	0.5 / 1 / 2 / 4 / 6 / 10 A DC (adjustable per output channel)
Internal output fuse	15 A DC (per output channel)	15 A DC (per output channel)
Active current limitation	Typ. 2.0 x $I_N$ (0.5 - 1 A) / Typ. 1.5 x $I_N$ (2 - 10 A)	Typ. 2.0 x $I_N$ (0.5 - 1 A) / Typ. 1.5 x $I_N$ (2 - 10 A)
<b>Load circuit</b>		
Shutdown time	0.02 s (> 1.3 x $I_N$ ) / 30 s (1.1 ... 1.3 x $I_N$ )	0.02 s (> 1.3 x $I_N$ ) / 30 s (1.1 ... 1.3 x $I_N$ )
<b>Reset input</b>		
Input voltage range	7 V DC ... 30 V DC (falling edge)	7 V DC ... 30 V DC (falling edge)
<b>General data</b>		
Dimensions W / H / D	41 mm / 130 mm / 121 mm	41 mm / 130 mm / 121 mm
Ambient temperature (operation)	-25°C ... 70°C (startup at -40 C type-tested)	-25°C ... 70°C (startup at -40 C type-tested)
Degree of protection	IP20	IP20
Standards/regulations	EN 61000-6-2 / EN 61000-6-3 / EN 60068-2-6 / EN 60068-2-11	EN 61000-6-2 / EN 61000-6-3 / EN 60068-2-6 / EN 60068-2-11
	Ordering data	Ordering data
Description	<b>Type</b>	<b>Type</b>
Multi-channel electronic device circuit breaker	<b>Order No.</b>	<b>Order No.</b>
	<b>Pcs. / Pkt.</b>	<b>Pcs. / Pkt.</b>
	<b>CBM E4 24DC/0.5-10A NO-R</b>	<b>CBM E8 24DC/0.5-10A NO-R</b>
	<b>2905743</b>	<b>2905744</b>
	<b>1</b>	<b>1</b>

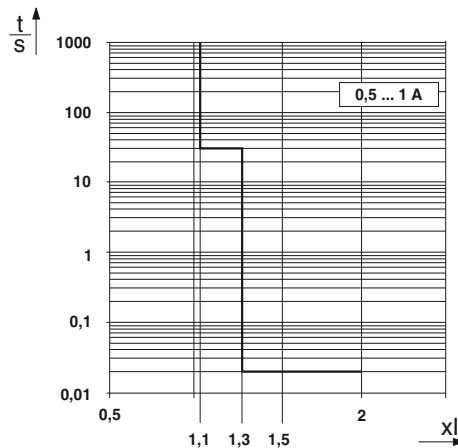

Tripping characteristic in the DC range

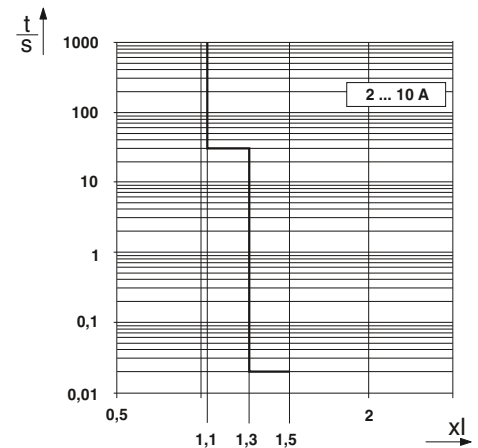

Tripping characteristic in the DC range

**Device circuit breaker board**

- Reduced installation time thanks to multi-channel device circuit breaker board (4/8/12 channels)
- Space savings of up to 35% thanks to compact design
- Fuse protection of up to 12 A per channel provides best possible protection for connected loads
- Up to 4 loads can be protected simultaneously with the additional terminal points
- Integrated group remote signaling ensures that you are always kept informed
- High current carrying capacity of the board supports supply of up to 60 A
- Maximum overcurrent protection over long cable paths thanks to device circuit breakers with SFB characteristic curve or electronic device circuit breakers

<b>Notes:</b>
For CBB TM... boards, see phoenixcontact.net/products
The board is supplied <b>without</b> a plug.
For dimensional drawings, see phoenixcontact.net/products

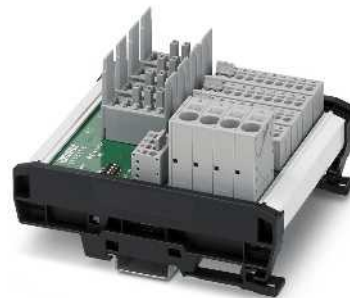

DIN-rail-mountable

<b>Rated data</b>	
Rated voltage	Main circuit Remote indication circuit
Rated current $I_N$	Complete main circuit Main circuit per channel Remote indication circuit
Rated insulation voltage $U_i$	
Rated surge voltage	
Max. capacitive load	
Rated surge voltage	
<b>General data</b>	
Dimensions W / H / D	
Ambient temperature (operation)	
Degree of protection	
Test standards	

Technical data			
	CBB 04	CBB 08	CBB 12
Rated voltage	-	24 V DC	24 V DC
Main circuit	24 V DC	24 V DC	24 V DC
Remote indication circuit	24 V DC	24 V DC	24 V DC
Rated current $I_N$			
Complete main circuit	48 A DC	60 A DC	60 A DC
Main circuit per channel	12 A DC	12 A DC	12 A DC
Remote indication circuit	0.5 A DC	0.5 A DC	0.5 A DC
Rated insulation voltage $U_i$			
Rated surge voltage	0.5 kV	0.5 kV	0.5 kV
Max. capacitive load			
Rated surge voltage	0.5 kV	0.5 kV	0.5 kV
<b>Dimensions W / H / D</b>			
	108.5 mm / 127.8 mm / 70.8 mm	170 mm / 127.8 mm / 70.8 mm	232 mm / 127.8 mm / 70.8 mm
<b>Ambient temperature (operation)</b>			
	-30°C ... 60°C	-30°C ... 60°C (at 48 A, see derating)	-30°C ... 60°C (at 48 A, see derating)
<b>Degree of protection</b>			
		IP20 (terminal blocks and fuse holders) IP00 (PCB)	
<b>Test standards</b>			
		DIN EN 50178 / DIN EN 61000-6-2:2005 / DIN EN 61000-6-3:2007+A1:2011 /	

<b>Description</b>
<b>Device circuit breaker board</b> , for accommodating device circuit breakers
With 4 channels
With 8 channels
With 12 channels

Ordering data		
Type	Order No.	Pcs. / Pkt.
CBB 04 2X2RC-PT	2905238	1
CBB 08 2X4RC-PT	2905240	1
CBB 12 2X6RC-PT	2905241	1

### CB device circuit breakers

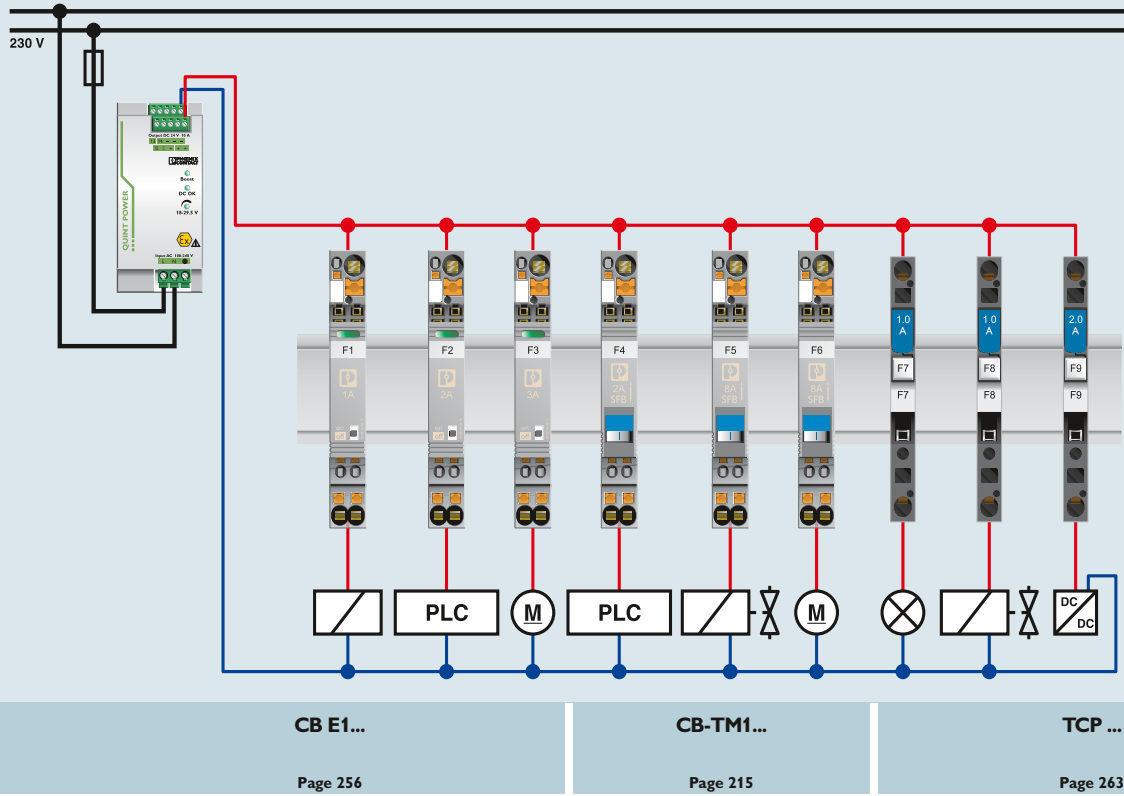

### CBM device circuit breaker

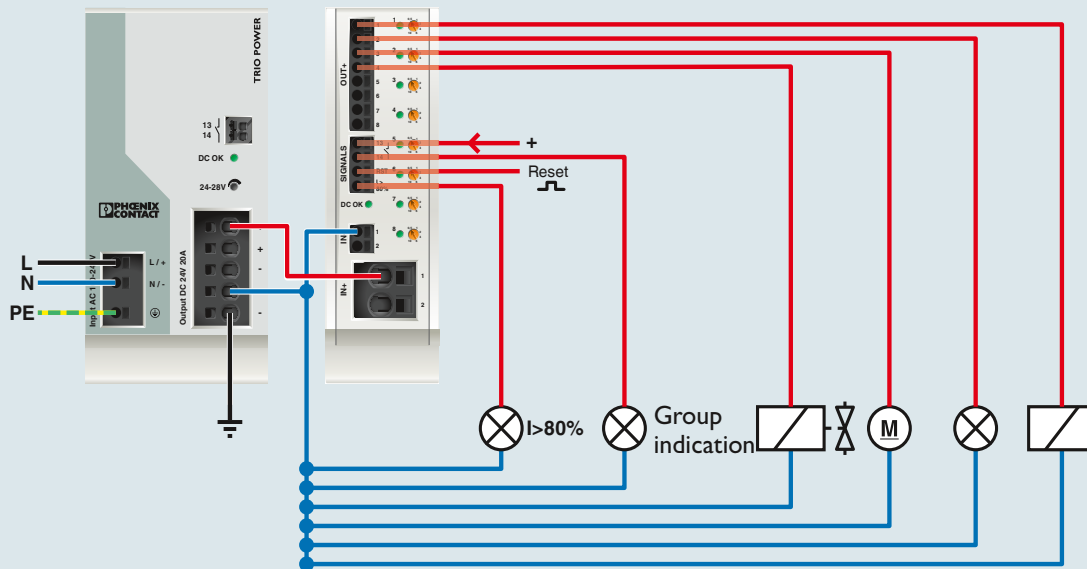

**CBM**

Page 258

Device circuit breaker board

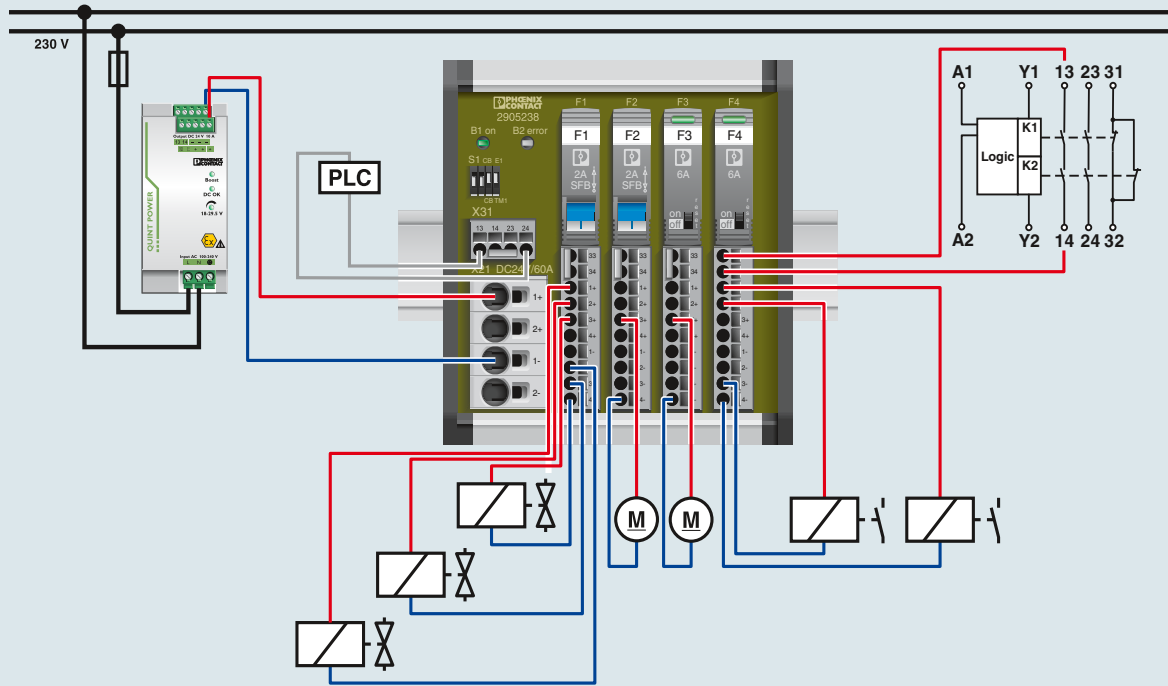

CBB ...RC-PT

## Device circuit breakers

### TCP thermal circuit breaker

- Plug-in thermal miniature circuit breakers combine the protective mechanism of an auto flat-type fuse with the advantages of a circuit breaker
- In the event of an error, the time-sensitive search for a suitable replacement fuse is eliminated thanks to the reclosure function
- The area of application extends to the protection of integrated circuits in all battery and onboard systems with up to 32 V DC
- Fits in all fuse holders designed for flat-type fuse inserts according to ISO 8820-3 (DIN 72581-3)
- A version with screw or spring-cage connection is used as a basic terminal block

**You can find more fuse terminal blocks in Catalog 3, Modular terminal blocks.**

Notes:
1) If the fuse is faulty, the downstream circuit is not off load.
Attention: The reset button must not be obstructed. During installation, please leave enough room to operate the button.
For additional technical data, drawings, and accessories, please visit <a href="http://phoenixcontact.net/products">phoenixcontact.net/products</a> .
You can find a wide selection of fuse terminal blocks in Catalog 3, Modular terminal blocks

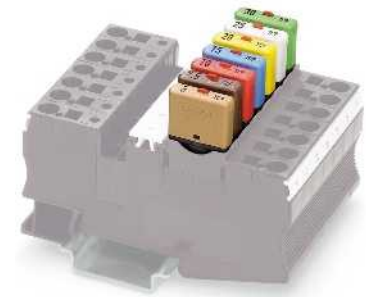

For fuse holder

Rated data
Rated voltage
Nominal current $I_N$
Disconnection
Shutdown time
Fuse type
Rated short-circuit switching capacity $I_{sc}$
General data
Dimensions W / H / D
Height
Ambient temperature (operation)
Degree of protection

#### ERIC

Total width 6 mm

Technical data		
IEC	UL / CUL	CSA
32 V DC	-	-
Depends on the product version selected		
See tripping characteristic		
Slow-blow		
$\leq 50$ A (300 shutdown operations)		
6 mm / 20.3 mm / 24 mm		
17 mm		
-40°C ... 85°C		
IP30 (actuation area)		

Description	Nominal current
<b>Single-position, thermal circuit breaker, for fuse holders in acc. with ISO 8820-3</b>	
	5 A
	7,5 A
	10 A
	15 A
	20 A
	25 A
	30 A
	40 A

Ordering data		
Type	Order No.	Pcs. / Pkt.
TCP 5/DC32V	0700005	50
TCP 7,5/DC32V	0700007	50
TCP 10/DC32V	0700010	50
TCP 15/DC32V	0700015	50
TCP 20/DC32V	0700020	50
TCP 25/DC32V	0700025	50
TCP 30/DC32V	0700030	50
TCP 40/DC32V	0700040	50

Fuse terminal block, for flat-type fuses
With LED for 12 V DC, 1.7 mA <sup>1)</sup>
With LED for 24 V DC, 1.9 mA <sup>1)</sup>
Fuse terminal block, for mounting on NS 32... or NS 35...
With LED for 12 V DC
With LED for 24 V DC, 1.9 mA <sup>1)</sup>

Accessories		
ST 4-FSI/C	3036372	50
ST 4-FSI/C-LED 12	3036495	50
ST 4-FSI/C-LED 24	3036505	50
UK 6-FSI/C	3118203	50
UK 6-FSI/C-LED12	3001925	50
UK 6-FSI/C-LED24	3001938	50

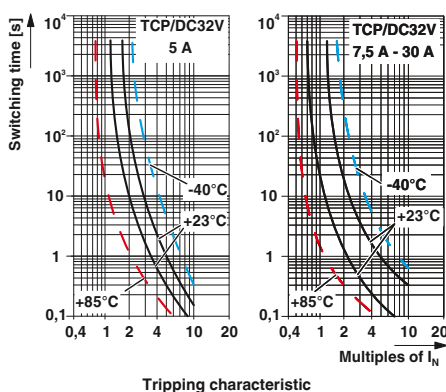

**TCP thermal circuit breaker**

- The reclosable thermal circuit breaker is available in nine nominal current levels ranging from 0.25 to 10 A
- The integrated switching function enables immediate reclosure and thus ensures the availability of the system
- Compact design
- A version with screw or spring-cage connection is used as a basic terminal block
- Potential distribution possible by means of bridges

A complete data sheet is available to download for each product at [phoenixcontact.net/products](http://phoenixcontact.net/products).

**Notes:**

**Note:**  
When mounted in rows, the nominal current of the devices can be transmitted only at 80% or must be correspondingly oversized.

For additional technical data, drawings, and accessories, please visit [phoenixcontact.net/products](http://phoenixcontact.net/products).



Can be plugged into a fuse terminal block

CE, RoHS, REACH, ENEC  
Total width 8.2 mm

Rated data	
Rated voltage	250 V AC
Rated voltage	65 V DC
Nominal current $I_N$	Depends on the product version selected
Disconnection	
Shutdown time	See tripping characteristic
Fuse type	Slow-blow
Rated short-circuit switching capacity $I_{cm}$	-
General data	
Dimensions W / H / D	8.2 mm / 64 mm / 88.5 mm
Ambient temperature (operation)	-20°C ... 60°C
Degree of protection	IP40 (actuation area)

Technical data		
IEC	UL / CUL	CSA
250 V AC	-	-
65 V DC	-	-
Depends on the product version selected		
See tripping characteristic		
Slow-blow		
-		
8.2 mm / 64 mm / 88.5 mm		
-20°C ... 60°C		
IP40 (actuation area)		

Description	Nominal current
<b>Thermal miniature circuit breaker</b> , can be plugged into UK 6 FSI/C or ST 4-FSI/C fuse terminal block	
	0.25 A
	0.5 A
	1 A
	2 A
	3 A
	4 A
	6 A
	8 A
	10 A

Ordering data		
Type	Order No.	Pcs. / Pkt.
TCP 0,25A	0712123	20
TCP 0,5A	0712152	20
TCP 1A	0712194	20
TCP 2A	0712217	20
TCP 3A	0712233	20
TCP 4A	0712259	20
TCP 6A	0712275	20
TCP 8A	0712291	20
TCP 10A	0712314	20

**Fuse terminal block**, for mounting on NS 32... or NS 35...

**Fuse terminal block**, for flat-type fuses

Accessories		
UK 6-FSI/C	3118203	50
ST 4-FSI/C	3036372	50

**Lateral groove marking**

For ZB 5, see page 135

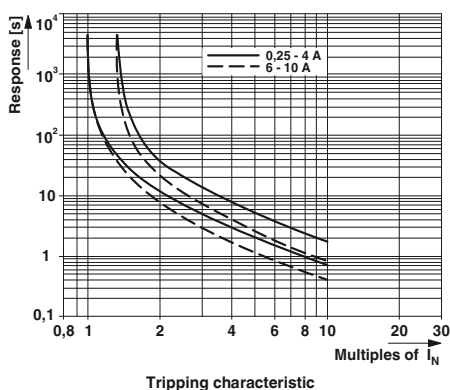

## Device circuit breakers

### Thermomagnetic circuit breaker UT 6-TMC ...

- Thermomagnetic circuit breakers feature a compact design, large-surface marking options, and a double plug-in bridge shaft
- With bridge shafts enabling them to be bridged together easily
- 12.3 mm compact design
- High level of system availability thanks to their reclosure function and clear status display
- Eleven nominal current levels can be selected from 0.5 A to 16 A
- Clear assignment of the relevant circuit breaker thanks to the large center marking area

A complete data sheet is available to download for each product at [phoenixcontact.net/products](http://phoenixcontact.net/products).



DIN-rail-mountable

Total width 12.3 mm

Rated data	
Rated voltage	240 V AC
Rated voltage	28 V DC
Nominal current $I_N$	Depends on the product version selected
Disconnection	
Shutdown time	See tripping characteristic
Fuse type	Normal blow (M1)
Rated short-circuit switching capacity $I_{cn}$	200 A (240 V AC) / 400 A (28 V DC)
Cycles, max.	6000 (at 1 x $I_N$ )
General data	
Dimensions W / H / D	12.3 mm / 85.5 mm / 89.5 mm
Connection method	Screw connection
Connection data solid / stranded / AWG	0.2 ... 10 mm <sup>2</sup> / 0.2 ... 10 mm <sup>2</sup> / 24 - 8
Stranded conductor cross section with ferrule	0.25 ... 6 mm <sup>2</sup>
Ambient temperature (operation)	-30°C ... 60°C
Degree of protection	IP40 (actuation area) / IP20 (connection area)
Standards/regulations	EN 60934 / UL 1077 / CSA 22.2

Technical data		
IEC	UL / CUL	CSA
240 V AC	240 V AC	-
28 V DC	28 V DC	-
Depends on the product version selected		
See tripping characteristic		
Normal blow (M1)		
200 A (240 V AC) / 400 A (28 V DC)		
6000 (at 1 x $I_N$ )		
12.3 mm / 85.5 mm / 89.5 mm		
Screw connection		
0.2 ... 10 mm <sup>2</sup> / 0.2 ... 10 mm <sup>2</sup> / 24 - 8		
0.25 ... 6 mm <sup>2</sup>		
-30°C ... 60°C		
IP40 (actuation area) / IP20 (connection area)		
EN 60934 / UL 1077 / CSA 22.2		

Description	Nominal current
Thermomagnetic circuit breaker, for mounting on NS 35...	
	0.5 A
	1 A
	2 A
	4 A
	5 A
	6 A
	8 A
	10 A
	12 A
	15 A
	16 A

Ordering data		
Type	Order No.	Pcs. / Pkt.
UT 6-TMC M 0,5A	0916603	6
UT 6-TMC M 1A	0916604	6
UT 6-TMC M 2A	0916605	6
UT 6-TMC M 4A	0916606	6
UT 6-TMC M 5A	0916607	6
UT 6-TMC M 6A	0916608	6
UT 6-TMC M 8A	0916609	6
UT 6-TMC M 10A	0916610	6
UT 6-TMC M 12A	0916611	6
UT 6-TMC M 15A	0916612	6
UT 6-TMC M 16A	0916613	6

Jumper, red	Number of positions
	2
	3
	4
	5
	10
	20

Accessories		
	Order No.	Pcs. / Pkt.
FBS 2-6	3030336	50
FBS 3-6	3030242	50
FBS 4-6	3030255	50
FBS 5-6	3030349	50
FBS 10-6	3030271	10
FBS 20-6	3030365	10

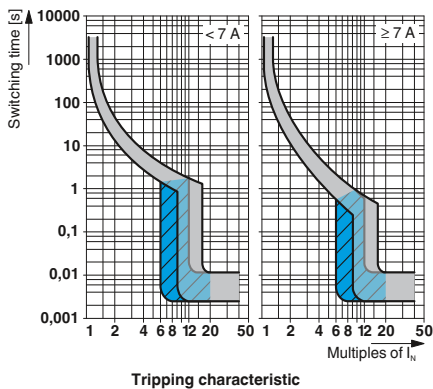



### Thermomagnetic circuit protector TMC

- Available with fast-blow and medium-blow characteristic curve for various nominal current strengths
- Single or two-pos. main current path

<b>Notes:</b>
1) Please observe the type key below.
2) Main contact
For additional technical data, drawings, and accessories, please visit <a href="http://phoenixcontact.net/products">phoenixcontact.net/products</a> .



DIN-rail-mountable



Can be plugged onto base

Total width 12.5 mm

Technical data			
IEC	UL / CUL	CSA	
250 V AC	-	-	
65 V DC	-	-	
Nominal current I <sub>N</sub> Depends on the product version selected			
Shutdown time See tripping characteristic			
Fuse type Fast blow (F1)			
Rated short-circuit switching capacity I <sub>sc</sub> 400 A / 2500 A (32 V DC)			
Dimensions W / H / D 12.5 mm / 82.5 mm / 96 mm			
Connection method Screw connection			
Connection data solid / stranded / AWG 0.2 ... 6 mm <sup>2</sup> / 0.2 ... 4 mm <sup>2</sup> / 24 - 10			
Stranded conductor cross section with ferrule 0.25 ... 4 mm <sup>2</sup>			
Ambient temperature (operation) -30°C ... 60°C			
Degree of protection IP30 (actuation area) / IP20 (connection area)			

Ordering data		
Type	Order No.	Pcs. / Pkt.
TMC 1 F1 100 0,2A	0914015	6

Accessories		
SPRING-LOCK	0713009	10
TMCP SOCKET M	0916589	10
TMCP CONNECT LR	0916592	3
TMCP SB	0916602	6

Total width 12.5 mm

Technical data			
IEC	UL / CUL	CSA	
250 V AC	-	-	
65 V DC	-	-	
Nominal current I <sub>N</sub> Depends on the product version selected			
Shutdown time See tripping characteristic			
Fuse type Fast blow (F1)			
Rated short-circuit switching capacity I <sub>sc</sub> 400 A / 2500 A (32 V DC)			
Dimensions W / H / D 38 mm / 115 mm / 121 mm			
Connection method plug-in			
Connection data solid / stranded / AWG - / - / -			
Stranded conductor cross section with ferrule -			
Ambient temperature (operation) -30°C ... 60°C			
Degree of protection IP30 (actuation area) / IP00 (connection area)			

Ordering data		
Type	Order No.	Pcs. / Pkt.
TMCP 1 F1 300 0,2A	0915506	6

Accessories		
SPRING-LOCK	0713009	10
TMCP SOCKET M	0916589	10
TMCP CONNECT LR	0916592	3
TMCP SB	0916602	6

Description	Nominal current
<b>Thermomagnetic circuit breaker</b> , with universal foot for mounting on NS 32... or NS 35... <sup>1)</sup>	
<b>Thermomagnetic circuit breaker</b> , plug-in, single, two or three-position <sup>1)</sup>	

<b>Spring lock</b> , for mechanical locking in the case of overhead mounting, 1-pos.
<b>Modular socket</b> , 2-position, for holding two circuit breakers, each with a single position
<b>Socket termination elements</b> , can be plugged in both to the left and right, contain the connections for the reset inputs/group query
<b>Signal bridge</b> , plug-in, for bridging group signaling when there is a free slot on the TMCP SOCKET M socket

### TMC and TMCP type keys

The type key indicates the unique structure of the product.

Type	Main current paths	Characteristic curve	Auxiliary contact versions	Nominal current
TMC or TMCP	1 ≙ Single-pos. 2 ≙ Two-pos. 3 ≙ Three-pos.	F1 ≙ Therm. 1.05 - 1.4 I <sub>N</sub> , magn. 2 - 4 I <sub>N</sub> DC (fast-blow), <b>Only for DC applications</b> M1 ≙ Therm. 1.05 - 1.4 I <sub>N</sub> , magn. 6 - 12 I <sub>N</sub> AC, 7.8 - 15.6 I <sub>N</sub> DC (medium-blow)	100 ≙ Single-pos.: 1 N/O contact 200 ≙ Single-pos.: 1 N/C contact 120 ≙ Two-pos.: 1 N/O contact, 1 N/C contact 122 ≙ Three-pos.: 1 N/O contact, 2 N/C contacts 300 <sup>4)</sup> ≙ 1 N/O contact and 1 N/C contact per position	0.2 A 2.5 A 0.3 A 3 A 0.4 A 4 A 0.5 A 5 A 0.6 A 6 A 0.8 A 8 A 1 A 10 A 1.5 A 12 A 2 A 16 A

### Ordering example:

TMC with single-pos. main current path, one N/O contact, medium-blow characteristic curve, and a nominal current of 2 A.

TMC	1	M1	100	2 A
-----	---	----	-----	-----

<sup>4)</sup> Only version for TMCP, cannot be used for TMC.

# Protective devices

## Device circuit breakers

### Plug-in electronic circuit breakers

- Device circuit breakers for protecting against voltage dips caused by overloads and short circuits
- Integrated active current limitation
- Remote control possible
- Maximum ease of maintenance, thanks to the two-piece design
- Snap-in function for secure hold and easy removal
- Plug coding possible
- Slim design

**Notes:**  
For additional technical data, drawings, and accessories, please visit [phoenixcontact.net/products](http://phoenixcontact.net/products).

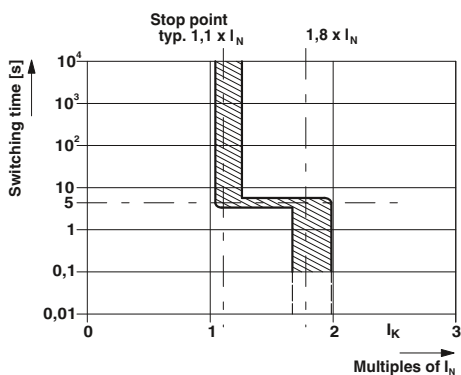

With reset input and status output



Total width 12.5 mm

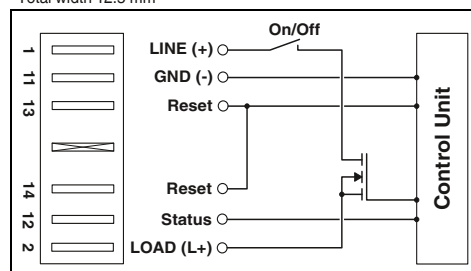

Rated data	
Operating voltage	24 V DC
Nominal current $I_N$	Depends on the product version selected
Disconnection	
Shutdown time	See tripping characteristic
Shutdown	Typ. $1.8 \times I_N$
Active current limitation	active
General data	
Temperature range	$0^\circ\text{C} \dots 50^\circ\text{C}$ (non-condensing)
Degree of protection	IP30 (actuation area)
Standards/regulations	UL 2367 / UL 508 / CSA 22.2

#### Technical data

24 V DC  
Depends on the product version selected

See tripping characteristic  
Typ.  $1.8 \times I_N$   
active

$0^\circ\text{C} \dots 50^\circ\text{C}$  (non-condensing)  
IP30 (actuation area)  
UL 2367 / UL 508 / CSA 22.2

#### Ordering data

Description	Nominal current
<b>Electronic circuit breaker</b> , can be plugged into TMCP base, signaling via LED	1 A
	2 A
	3 A
	4 A
	6 A
	8 A
	10 A
12 A	
<b>Electronic circuit breaker</b> , as above, but nominal current can be set via a switch, 1 A and 2 A	1 A
	(adjustable)
<b>Electronic circuit breaker</b> , as above, but nominal current can be set via a switch, 3 A and 6 A	3 A
	(adjustable)

Type	Order No.	Pcs. / Pkt.
ECP-E 1A	0900113	5
ECP-E 2A	0900210	5
ECP-E 3A	0900317	5
ECP-E 4A	0900414	5
ECP-E 6A	0900618	5
ECP-E 8A	0900812	5
ECP-E 10A	0901002	5
ECP-E-12A	0900126	5

<b>Spring lock</b> , for mechanical locking in the case of overhead mounting, 1-pos.
<b>Modular socket</b> , 2-position, for holding two circuit breakers, each with a single position
<b>Socket termination elements</b> , can be plugged in both to the left and right, contain the connections for the reset inputs/group query
<b>Signal bridge</b> , plug-in, for bridging group signaling when there is a free slot on the TMCP SOCKET M socket

#### Accessories

SPRING-LOCK	0713009	10
TMCP SOCKET M	0916589	10
TMCP CONNECT LR	0916592	3
TMCP SB	0916602	6



With control input and group query



With reset input and group query



With floating signal contact and electrical isolation

ERIC Total width 12.5 mm

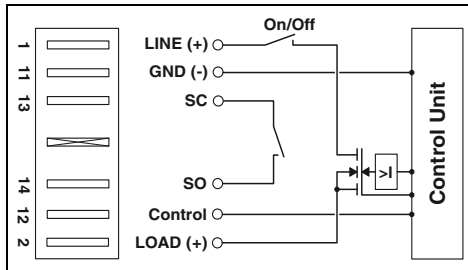

### Technical data

24 V DC  
Depends on the product version selected

See tripping characteristic  
Typ.  $1.8 \times I_N$   
active

0°C ... 50°C (non-condensing)  
IP30 (actuation area)  
UL 2367 / UL 508 / CSA 22.2

### Ordering data

Type	Order No.	Pcs. / Pkt.
ECP-E2-1A	0900139	5
ECP-E2-2A	0900236	5
ECP-E2-3A	0900333	5
ECP-E2-4A	0900430	5
ECP-E2-6A	0900634	5
ECP-E2-8A	0900838	5
ECP-E2-10A	0900100	5
ECP-E2-12A	0900207	5

### Accessories

Accessories	Order No.	Pcs.
SPRING-LOCK	0713009	10
TMCP SOCKET M	0916589	10
TMCP CONNECT LR	0916592	3
TMCP SB	0916602	6

ERIC Total width 12.5 mm

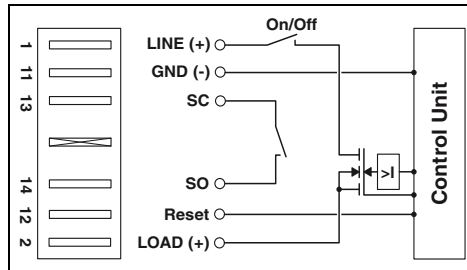

### Technical data

24 V DC  
Depends on the product version selected

See tripping characteristic  
Typ.  $1.8 \times I_N$   
active

0°C ... 50°C (non-condensing)  
IP30 (actuation area)  
UL 2367 / UL 508 / CSA 22.2

### Ordering data

Type	Order No.	Pcs. / Pkt.
ECP-E3 1A	0912041	5
ECP-E3 2A	0912042	5
ECP-E3 3A	0912043	5
ECP-E3 4A	0912044	5
ECP-E3 6A	0912046	5
ECP-E3 8A	0912048	5
ECP-E3 10A	0912050	5
ECP-E3 12A	0912052	5

### Accessories

Accessories	Order No.	Pcs.
SPRING-LOCK	0713009	10
TMCP SOCKET M	0916589	10
TMCP CONNECT LR	0916592	3
TMCP SB	0916602	6

ERIC Total width 12.5 mm

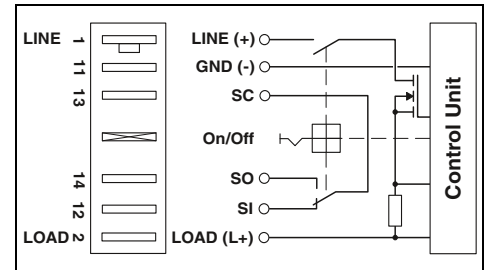

### Technical data

24 V DC  
Depends on the product version selected

See tripping characteristic  
Typ.  $1.8 \times I_N$   
active

0°C ... 50°C (non-condensing)  
IP30 (actuation area)  
-

### Ordering data

Type	Order No.	Pcs. / Pkt.
ECP 2	0911034	5
ECP 3	0911047	5
ECP 4	0912034	5
ECP 6	0912033	5
ECP 8	0912019	5
ECP 10	0912020	5
ECP 1-2	0912018	5
ECP 3-6	0916536	5

### Accessories

Accessories	Order No.	Pcs.
SPRING-LOCK	0713009	10
TMCP SOCKET M	0916589	10
TMCP CONNECT LR	0916592	3
TMCP SB	0916602	6

# Protective devices

## Device circuit breakers

### EC-E1 and EC-E4 electronic circuit breakers

- Selective protection of all 24 V DC load circuits at switched-mode power supply units
  - A combination of active electronic current limitation in the event of short circuit and overload shutdown ensures that the circuit breaker can respond to overloads faster than the switched-mode power supply unit
  - The residual current is always limited to 1.3 - 1.8 times the nominal current
- A complete data sheet is available to download for each product at [phoenixcontact.net/products](http://phoenixcontact.net/products).

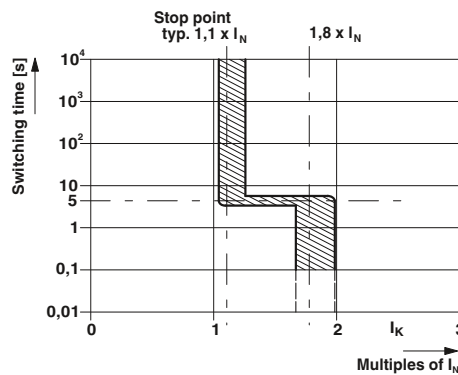

With signal contact as N/C contact or N/O contact

ERC  
Ex:  
Total width 12.5 mm

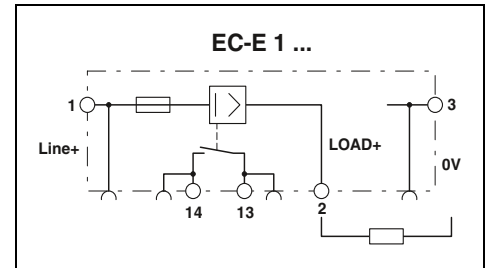

**Notes:**  
For additional technical data, drawings, and accessories, please visit [phoenixcontact.net/products](http://phoenixcontact.net/products).

Rated data	
Operating voltage	24 V DC
Nominal current $I_N$	Depends on the product version selected
Disconnection	
Shutdown time	See tripping characteristic
Fuse type	Electronic
General data	
Dimensions W / H / D	12.5 mm / 83 mm / 80 mm
Connection method	Screw connection
Connection data solid / stranded / AWG	0.5 ... 16 mm <sup>2</sup> / 0.5 ... 16 mm <sup>2</sup> / 20 - 6
Stranded conductor cross section with ferrule	0.5 ... 10 mm <sup>2</sup>
Ambient temperature (operation)	0°C ... 50°C (non-condensing)
Degree of protection	IP20 (housing)
Inflammability class according to UL 94	V0

Technical data		
IEC	UL / CUL	CSA
24 V DC		
Depends on the product version selected		
See tripping characteristic		
Electronic		
12.5 mm / 83 mm / 80 mm		
Screw connection		
0.5 ... 16 mm <sup>2</sup> / 0.5 ... 16 mm <sup>2</sup> / 20 - 6		
0.5 ... 10 mm <sup>2</sup>		
0°C ... 50°C (non-condensing)		
IP20 (housing)		
V0		

Description	Nominal current
<b>Electronic circuit breaker, signal contact: 1 N/O contact</b>	
	0.5 A
	1 A
	2 A
	3 A
	4 A
	6 A
	8 A
	10 A
	12 A
<b>Electronic circuit breaker, signal contact: 1 N/C contact</b>	
	0.5 A
	1 A
	2 A
	3 A
	4 A
	6 A
	8 A
	10 A
	12 A

Ordering data		
Type	Order No.	Pcs. / Pkt.
EC-E1 0,5A	0903022	6
EC-E1 1A	0903023	6
EC-E1 2A	0903024	6
EC-E1 3A	0903025	6
EC-E1 4A	0903026	6
EC-E1 6A	0903028	6
EC-E1 8A	0903029	6
EC-E1 10A	0903030	6
EC-E1 12A	0903031	6
<b>Electronic circuit breaker, signal contact: 1 N/C contact</b>		
EC-E4 0,5A	0903040	6
EC-E4 1A	0903032	6
EC-E4 2A	0903033	6
EC-E4 3A	0903034	6
EC-E4 4A	0903035	6
EC-E4 6A	0903036	6
EC-E4 8A	0903037	6
EC-E4 10A	0903038	6
EC-E4 12A	0903039	6

<b>Continuous bridge</b> , 500 mm long, isolated, can be cut to length, for potential distribution
Nominal current: 32 A
<b>Screwdriver</b>

Accessories		
FBST 500-PLC BU	2966692	20
FBST 500-PLC RD	2966786	20
FBST 500 TMC-N GY	0901028	10
SZS 0,6X3,5	1205053	10

EC-E electronic circuit breakers

- Selective protection of all 24 V DC load circuits at switched-mode power supply units
  - A combination of active electronic current limitation in the event of short circuit and overload shutdown ensures that the circuit breaker can respond to overloads faster than the switched-mode power supply unit
  - The residual current is always limited to 1.3 - 1.8 times the nominal current
- A complete data sheet is available to download for each product at [phoenixcontact.net/products](http://phoenixcontact.net/products).

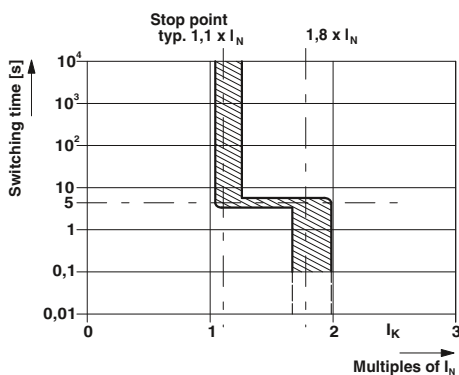

With reset input and status output

**Notes:**  
For additional technical data, drawings, and accessories, please visit [phoenixcontact.net/products](http://phoenixcontact.net/products).

ERIC  
Total width 12.5 mm

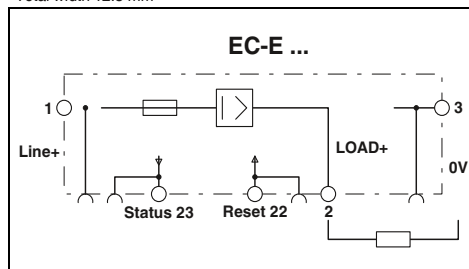

Rated data	
Operating voltage	24 V DC
Nominal current $I_N$	0.5 ... 12 A
Disconnection	
Shutdown time	See tripping characteristic
Fuse type	Electronic
General data	
Dimensions W / H / D	12.5 mm / 83 mm / 80 mm
Connection method	Screw connection
Connection data solid / stranded / AWG	0.5 ... 16 mm <sup>2</sup> / 0.5 ... 16 mm <sup>2</sup> / 26 - 6
Stranded conductor cross section with ferrule	0.5 ... 10 mm <sup>2</sup>
Ambient temperature (operation)	0°C ... 50°C (non-condensing)
Degree of protection	IP20 (housing)
Inflammability class according to UL 94	V0

Technical data		
IEC	UL / CUL	CSA
24 V DC		
Depends on the product version selected		
See tripping characteristic		
Electronic		
12.5 mm / 83 mm / 80 mm		
Screw connection		
0.5 ... 16 mm <sup>2</sup> / 0.5 ... 16 mm <sup>2</sup> / 26 - 6		
0.5 ... 10 mm <sup>2</sup>		
0°C ... 50°C (non-condensing)		
IP20 (housing)		
V0		

Description	Nominal current
<b>Electronic circuit breaker, with reset input</b>	
	0.5 A
	1 A
	2 A
	3 A
	4 A
	6 A
	8 A
	10 A
	12 A

Ordering data			
Type	Order No.	Pcs. / Pkt.	
EC-E 0,5A DC24V	0903041	6	
EC-E 1A DC24V	0903042	6	
EC-E 2A DC24V	0903043	6	
EC-E 3A DC24V	0903044	6	
EC-E 4A DC24V	0903045	6	
EC-E 6A DC24V	0903046	6	
EC-E 8A DC24V	0903047	6	
EC-E 10A DC24V	0903048	6	
EC-E 12A DC24V	0903049	6	

**Continuous bridge**, 500 mm long, isolated, can be cut to length, for potential distribution

Nominal current: 32 A

Accessories		
Type	Order No.	Pcs. / Pkt.
FBST 500-PLC BU	2966692	20
FBST 500-PLC RD	2966786	20
FBST 500 TMC-N GY	0901028	10

### Installation notes for surge protective devices

#### Installation direction:

Surge protective devices with a multi-stage configuration which are looped into the circuit are marked "IN" and "OUT". They must be connected before the device to be protected so that "IN" points towards the direction from which the surge voltage is expected.

The device to be protected should be connected to the terminal points marked "OUT". This is the only way to ensure correct operation of the surge protective device in the event of a surge voltage coupling.

#### Connection:

The protective conductor connection of the system to be protected should be connected directly and via the shortest route to the ground connection of the surge protective device or the corresponding connection terminal block on the "OUT" side of the surge protective device.

This is the only way to ensure that impermissibly high voltages due to potential increases caused by discharge currents are prevented between the ground connections of the surge protective device and the device to be protected. The same is true for the connection between ground and the live conductors of the device to be protected (see figure: ground connection).

#### Equipotential bonding:

Correct operation of the surge protective devices requires complete equipotential bonding in accordance with the applicable regulations.

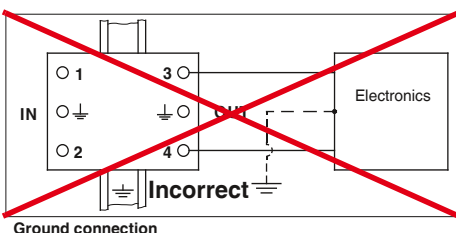
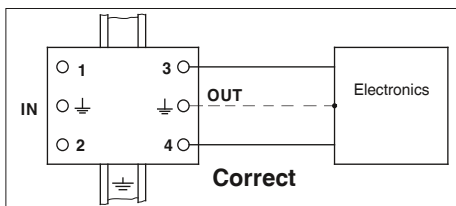

#### Cable routing:

Protected and unprotected cables must not be laid directly parallel to one another. They must be physically separated or shielded from one another so that surge voltages cannot be coupled from unprotected cables to protected ones. If crossed, cables that can influence one another must be crossed at right angles.

#### Quenching follow currents:

Gas-filled surge arresters only have limited self-quenching capability and are therefore almost always suitable for protecting message transmission systems.

The arresters easily meet the requirements of the usually high-impedance remote indication circuits. Distinct quenching behavior is observed under the following conditions in the case of systems with higher operating voltage or lower impedance:

**AC application:** if the possible short-circuit current of the source exceeds the alternating current carrying capacity, a fuse is required to prevent overheating caused by the follow current.

**DC application:** for voltages > 12 V DC, the possible short-circuit current of the source must not exceed 100 mA. Otherwise a fuse that enables shutdown within 5 seconds should be selected. Self-quenching capability is ensured for voltages ≤ 12 V. Please note, however, that the specific technical data for the product must always be observed.

**Backup fuse:** the system must be protected against impermissibly high short-circuit currents due to arrester overload. The maximum permissible or required backup fuse for the affected arrester is documented in the technical data of the relevant product.

### Surge voltage limiting components

The main function-specific components for lightning arresters and surge protective devices are spark gaps, gas-filled surge arresters, varistors, and diodes, as well as decoupling impedances.

All components have specific advantages and disadvantages. In order to achieve optimum protection, protective circuits and multi-stage protection concepts that combine various components can be implemented.

#### Suppressor diode

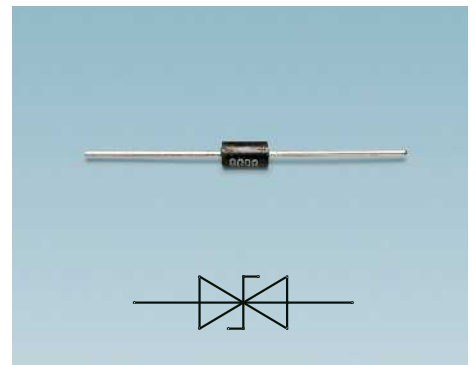

The reverse voltage  $U_R$  is the highest voltage that the diode can safely block. A current of 1 mA flows through the suppressor diode at the breakdown voltage  $U_B$ . At this point the suppressor diode starts limiting the surge voltage.

The maximum clamping voltage  $U_C$  is the highest voltage which can be present at the suppressor diode in the event of a peak pulse current  $I_{pp}$  (10/1000)  $\mu$ s.

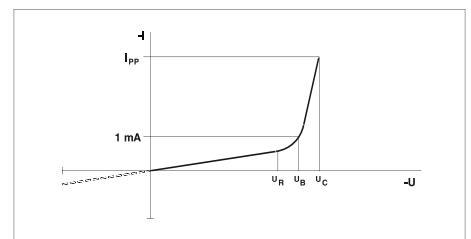

U/I characteristic curve of a suppressor diode

Explanation:

- $U_R$  = Reverse voltage
- $U_B$  = Breakdown voltage
- $U_C$  = Clamping voltage
- $I_{pp}$  = Peak pulse current
- $I_R$  = Reverse current

**Varistors**

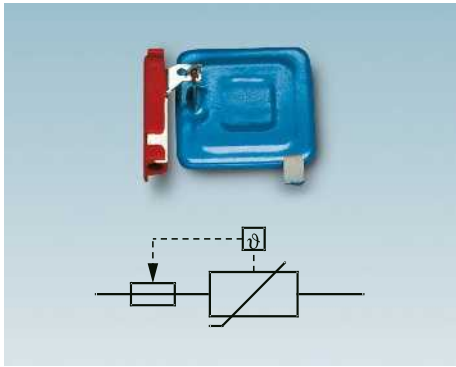

Block varistor with thermal disconnect device

Varistors are “voltage-dependent resistors” which, due to their voltage/current characteristic curves enable a high discharge capacity with a low residual voltage.

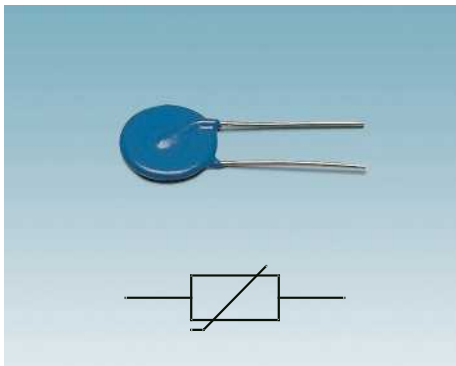

Disc varistor

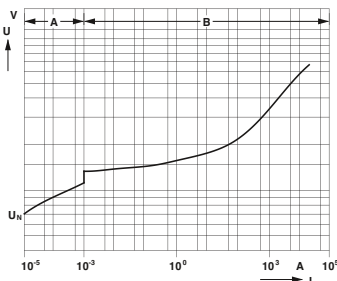

U/I characteristic curve of metal oxide varistors

Explanation:

- A = High-resistance operating area
- B = Low-resistance operating area/limiting area

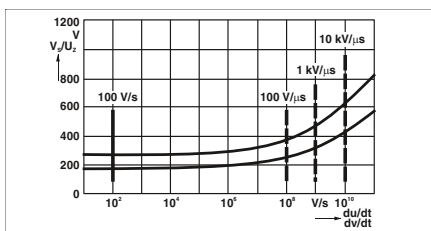

Characteristic ignition curve of a gas-filled surge arrester

- Static response behavior
- ■ ■ Dynamic response behavior

**Gas-filled surge arresters**

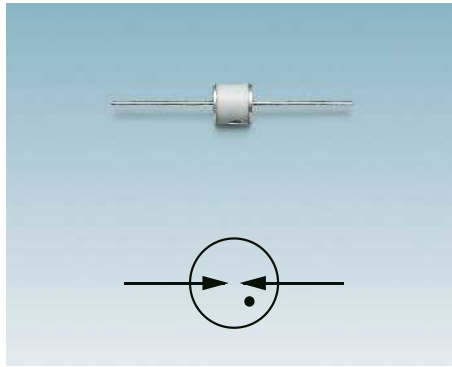

Gas-filled surge arresters consist of an electrode arrangement in a ceramic or glass tube. Between the electrodes is an inert gas, such as argon or neon. When the igniting voltage is reached, the component changes to a low-resistance state as a result of the gas discharge used. The igniting voltage is not a constant, instead it is dependent on the rate of rise of the surge voltage.

After igniting the discharge path, an arc voltage between 10 and 30 V typically occurs, which can be measured as a voltage drop at the arrester. In this low-resistance state, a line follow current, whose value depends on the impedance of the mains connected upstream, can flow through the arrester. In order to interrupt line follow currents that exceed the self-quenching capability, a fuse must be connected upstream of the surge arrester. Series connection of varistors or resistors is also possible.

The ArC spark gap in the FLASHTRAB lightning arrester is based on arc chopping technology. Two spark horns positioned opposite one another are kept at a distance by an isolator bridge bar. In addition, a baffle plate is fitted below the electrodes in the direction of the opening. In the event of a surge voltage, surface discharge occurs along the isolator bridge bar, which creates an arc. This is driven along the spark horns towards the baffle plate where it is chopped up. The resulting physical effects quench the arc and the associated line follow currents. A significant increase in the follow current quenching capacity can be achieved with spark gap types in which quenching plates are arranged around the spark horns.

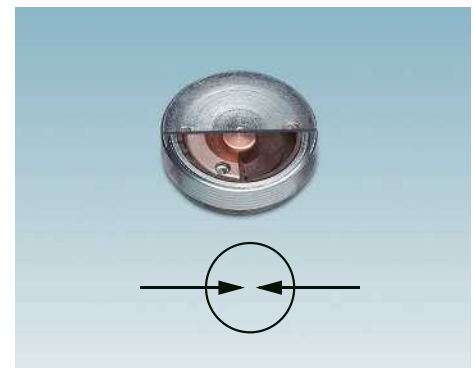

Encapsulated ArC spark gap

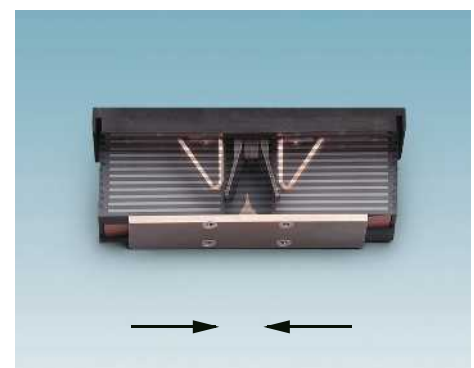

ArC spark gap with quenching plates

**Spark gaps**

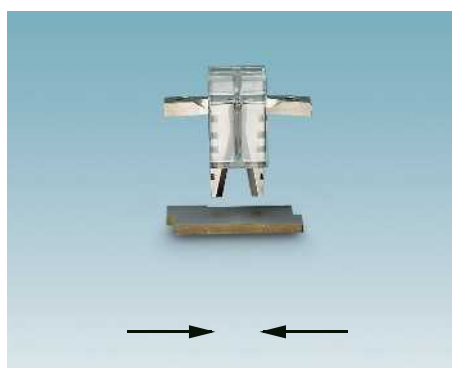

ArC spark gap

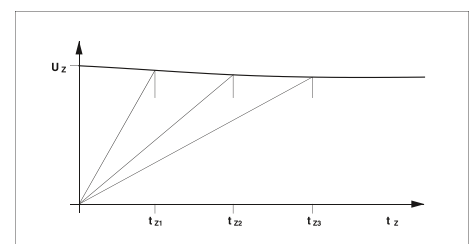

Characteristic ignition curve of a spark gap

### Surge protective devices

The wide range of different applications also requires numerous different surge protective devices with application-specific properties. Important criteria include the type of circuit, the surge-voltage limiting properties, and the design. The TRABTECH range from Phoenix Contact offers numerous versions, such as adapters, junction boxes or DIN-rail-mountable arresters in a modular and compact design, providing practical system solutions for all applications.

In line with their intended application, surge protective devices are designed for high electrical loads. However, excessive or very frequent surge voltages may lead to overload. This can result in a reduction or even failure of the protective function, and the affected protective device having to be replaced. Where possible, surge protective devices should therefore have a plug-in design and support testing.

The TRABTECH product range from Phoenix Contact takes these requirements into consideration as far as modern technology permits. The product range includes surge protective devices in the form of adapters, as well as devices with a two-piece plug-in modular design.

The protective devices in the FLASHTRAB, VALVETRAB, PLUGTRAB, and COMTRAB product ranges are particularly interesting with regard to their plug-in capability and testability. They have been developed with various protective circuits and different nominal voltages for applications in power supply, measurement and control, and data interface protection.

With components that are perfectly designed to work together, i.e., gas-filled surge arresters, varistors, and suppressor diodes depending on the protective circuit, their specific advantages are fully utilized.

### Explanation of terms

#### AC withstand voltage

The r.m.s. value of the highest sinusoidal voltage at mains frequency which will not lead to a disruptive discharge under the specified test conditions.

#### Aging

Modification of the original performance data due to disturbing pulses, operation or unfavorable ambient conditions.

#### Ambient conditions

The immediate ambient conditions for the device or the relevant air and creepage distances.

#### Arc voltage $U_{bo}$

The arc voltage is the instantaneous value of the voltage on a discharge path (arc discharge) during an arresting process.

#### Arrester

Item of equipment that mainly consists of voltage-dependent resistors and/or spark gaps. Both elements can be connected in series or in parallel, or even used individually. Arresters are used to protect other electrical equipment and electrical systems against impermissibly high surge voltages.

#### Associated electrical equipment

An item of electrical equipment in which not all circuits are intrinsically safe, but which contains circuits that can influence the safety of the intrinsically safe circuits to which they are connected.

#### Asymmetrical interference

Asymmetrical means that the source of interference and the potentially susceptible equipment are grounded, i.e., they have a capacitive or galvanic connection to the protective conductor. As shown in the figure, the interference moves from the source along both conductors to the potentially susceptible equipment and back via ground. The terms "common-mode interference" or "common mode" are also used.

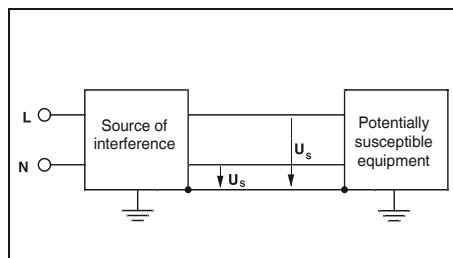

#### Asymmetrical voltage, common mode voltage

Average voltage between each conductor and a specified reference point, usually reference ground or ground.

#### Burst

Pulses which occur repeatedly within a specific time interval.

#### Common mode voltage

The common mode voltage is the voltage which occurs in the event of interference between live conductors and ground.

#### Coupling

Interaction between circuits, in which energy is transferred capacitively, inductively or galvanically from one circuit to the other.

#### Direct or close-up strikes

These cause surge voltages with an energy level that constitutes a considerable part of the total energy of the lightning discharge.

#### Discharge of static electricity; electrostatic discharge; ESD

The transmission of an electrical charge between bodies with different electrostatic potentials when they are in close proximity or touching.

#### Disconnect device

This is a device which disconnects a SPD from the mains when it fails. It is designed to prevent a permanent fault in the system caused by the faulty surge arrester and provide an optical indication of the faulty SPD.

#### Disturbance variable

The disturbance variable is an electromagnetic (or electrical or magnetic) variable, which can have an undesirable influence on electrical equipment.

#### Electromagnetic compatibility (EMC)

The ability of a device or system to operate without faults in an electromagnetic environment without itself causing electromagnetic interference, which would be unacceptable for other devices in this environment.

#### Electromagnetic environment

The sum of all electromagnetic phenomena at a given location.



### Electromagnetic interference

A loss in the quality of the operating behavior, such as malfunction or failure of electrical or electronic equipment, that is caused by an electromagnetic disturbance variable.

### Equipment to be protected

All equipment of a structural system or a range which requires surge protection or lightning protection.

### Equipotential bonding

The removal of potential differences between conductive parts, in which all points assume virtually the same potential.

A distinction is made between functional equipotential bonding and protective equipotential bonding.

### Equipotential bonding conductors

These are electrically conductive connections used to create equipotential bonding.

### Equipotential bonding strip

This is the strip which is designed to connect protective conductors, equipotential bonding conductors, and conductors for functional earth grounding to the ground conductor and the ground electrodes.

### Equipotential bonding system

This refers to all the interconnected equipotential bonding conductors, including the conductive parts such as housing or external conductive parts which work in the same way.

The equipotential bonding system can also be the grounding system or part of a grounding system.

### Exposure

Exposure is an insufficient distance between the lightning protection system and metal installations or electrical systems which leads to a risk of flashover or disruptive discharge in the event of a lightning strike.

### Exposure voltage

The exposure voltage is a voltage that occurs at the exposure point when lightning strikes the lightning protection system.

### Follow current $I_f$

Current which flows through the SPD following discharge and is supplied by the mains. The follow current differs considerably from the continuous operating current.

### Gas-filled surge arrester

The gas-filled surge arrester is a discharge path which is filled with a gas other than air, generally an inert gas.

### Ground

This expression refers to the earth and the ground.

### Ground conductor

A conductor which connects the equipment to be grounded to a ground electrode, as long as the ground conductor is not laid in the ground or, if laid in the ground, is insulated.

### Ground electrode

A conductor embedded in the ground with an electrically conductive connection to ground. Parts of supply lines to a ground electrode, which are not insulated in the ground, are considered to be parts of the ground electrode.

### Grounding

Grounding is the sum of all means and measures used for grounding.

### Grounding resistance

The resistance between the grounding system and the reference ground. The amount of grounding resistance depends on the interaction of the individual ground electrodes.

### Impulse sparkover voltage of 1.2/50 $\mu$ s

Highest voltage value before the disruptive discharge between the electrodes of the spark gap of a SPD.

### Impulse withstand voltage $U_{st}$

The peak value of the highest surge voltage with a predefined form and polarity, which will not lead to a disruptive discharge under the specified test conditions.

Note: the impulse withstand voltage is equal to or greater than the rated surge voltage.

### Inactive parts

Inactive parts are conductive parts that are electrically isolated from all live parts through basic insulation.

### Insertion attenuation

To determine the insertion attenuation of a SPD, the mains and frequency are specified. The attenuation value is defined as the ratio of voltages that occur immediately before and after the insertion point of the SPD to be tested. The result is expressed in decibels.

### Insulation coordination

The assignment of characteristic insulation data for an item of equipment for:

- Expected surge voltages
- Characteristic data of the surge protective device
- Expected ambient conditions
- Protective measures against contamination

### Interference suppression

Measure to reduce or avoid the electromagnetic disturbance variables that occur.

### Intrinsically safe circuit

A circuit protected against sparks and thermal effects that may occur under the conditions specified in DIN EN 60079-11 (which include error-free operation and specific fault conditions), which can cause the ignition of a particular explosive gas atmosphere.

### Intrinsically safe electrical equipment

Electrical equipment in which all circuits are intrinsically safe.

### Lightning protection system

All devices as a whole that provide external and internal lightning protection for the system to be protected.

### Lightning surge current $I_{imp}$

Lightning surge currents are characterized by the parameters peak value, charge, specific energy, and current rate of rise. The lightning surge current  $I_{imp}$  is a measurement for the discharge capacity of lightning arresters (class I). It is determined according to a defined test procedure using 10/350  $\mu$ s waveform test pulses.

### Lightning surge voltage

Surge voltage as a result of lightning discharge.

## Explanation of terms

### Lightning test current

The (10/350)  $\mu\text{s}$  lightning test current has a rise time of 10  $\mu\text{s}$  and a decay time to half-value of 350  $\mu\text{s}$ .

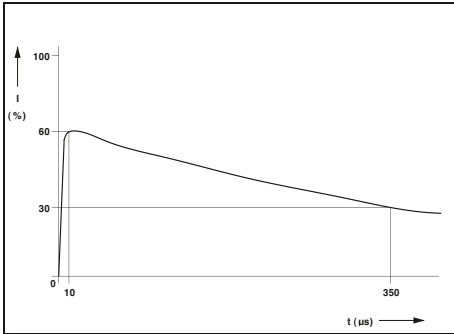

10/350 lightning current pulse according to IEC 62305-1

### Live parts

Live parts are conductors and conductive parts of equipment that are energized under normal operating conditions.

### Maximum continuous voltage $U_c$

The rated voltage is the maximum permissible r.m.s. value of the power-frequency AC voltage, which may be permanently applied to the protective paths of the arrester.

### Nominal current $I_N$ or load current $I_L$

Highest continuous current for products according to IEC 61643 which can flow through the surge protective device at the specified temperature without altering the electrical operating properties. For higher operating temperatures, the nominal current is lower (derating).

### Nominal discharge surge current $I_n$

Peak value of the current flowing through the SPD with surge form (8/20)  $\mu\text{s}$ . It is used to classify the SPD according to class II. Source: EN 61643-11

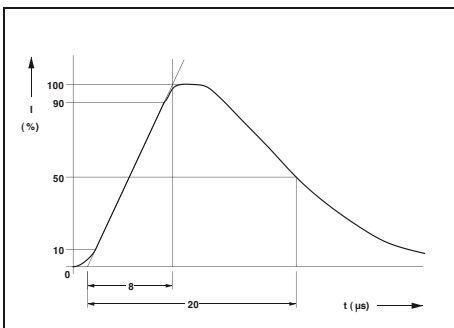

8/20 surge current pulse according to IEC 60060-1

### Nominal voltage $U_N$

A suitable rounded voltage value, which is specified by the manufacturer for equipment for the purpose of designation or identification.

### Normal mode voltage

The normal mode voltage is the voltage which occurs in the event of interference between two conductors of a circuit.

### Potentially susceptible equipment

All electrical equipment whose function can be influenced by disturbance variables is referred to as potentially susceptible equipment. Influence on function may be in the form of a functional disturbance, reduction in function, malfunction or failure.

### Protection level $U_p$

A parameter that characterizes the performance capabilities of the SPD with regard to voltage limitation via its connection terminal blocks. This value, which should be specified by the manufacturer, must be greater than the highest measured value of the clamping voltages.

### Protective paths

The voltage-limiting or switching components of the SPD can be connected between conductor/ conductor, conductor/ground, conductor/neutral conductor, and neutral conductor/ground or a combination of these options. These circuit types are referred to as protective paths.

### Pulse

Rapid, brief alteration of a physical variable, followed by a fast return to the original value.

### Pulse burst; burst

Result of a limited number of pulses or waves of a limited duration.

### Rate of rise

Average rate of change of a variable between two specified values, e.g., 10% and 90% of the peak value.

### Reference ground

An area of the earth, particularly of the earth's surface, which is so far away from the ground conductors that no noticeable voltages occur between any points of this area as a result of the current entering the earth.

### Remote strikes

These usually cause surge voltages with a significantly lower energy level than close-up strikes. Remote strikes are responsible for causing surge voltages in electrical and electronic systems.

### Residual current device (RCD)

Residual current devices are devices which isolate electrical systems from the power supply system as soon as the residual current to ground exceeds a specific value.

### Residual voltage $U_{res}$

The peak voltage value that occurs while discharge surge current is flowing via the terminal blocks of the SPD.

Source: EN 61643-11:2002

### Response

- A response is when either:
- The peak value of the ohmic components of the current flowing through the arrester reaches 5 mA
  - A voltage dip with an increase in the peak value of the current flowing through the arrester to 5 mA occurs

### Selective residual current device

Selective residual current devices are time-delayed circuit breakers.

### Short-circuit stability

Highest interference-free short-circuit current the SPD can withstand.

### Source of interference

A source of interference is the origin of disturbance variables. In principle, any electrical equipment, such as motors or fluorescent lamps, can be a source of interference.

### Specialist

A specialist is a person who, because of their education, experience, and instruction, and their knowledge of relevant regulations, can assess any required operations and recognize any possible dangers.

Note: when considering a person's professional training, several years' experience in the relevant field can also be taken into account.

### Spike

A relatively short single-polarity pulse.

### Surface discharge surge arrester

The surface discharge surge arrester, according to DIN VDE 0845 Part 1, is a discharge path in which gas discharge is initiated by means of surface discharge.

### Surge current of (8/20) $\mu\text{s}$

Surge current with a rise time of 8  $\mu\text{s}$  and a decay time to half-value of 20  $\mu\text{s}$ . Source: IEC 60060-1

**Surge current of (10/350)  $\mu$ s**

Surge current with a rise time of 10  $\mu$ s and a decay time to half-value of 350  $\mu$ s. Source: IEC 62305-1

**Surge protection equipment (SPE)**

Surge protection equipment consists of surge protective devices and all equipment in telecommunications systems, including their cables, used for surge protection.

**Surge protective device (SPD)**

A device to limit surge voltages and discharge surge currents. It contains at least one non-linear voltage-limiting component.

**Surge voltage**

Any voltage with a peak value that exceeds the corresponding peak value of the maximum continuous voltage under normal operating conditions. Source: EN 60664-1

**Surge voltage category**

Assignment of electrical equipment to the anticipated surge voltage.

**Surge voltage of (1.2/50)  $\mu$ s**

Surge voltage with a rise time of 1.2  $\mu$ s and a decay time to half-value of 50  $\mu$ s. Source: IEC 60060-1

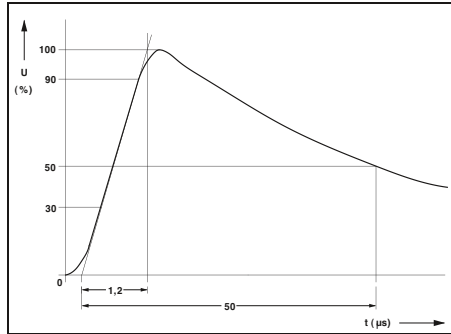

1.2/50 surge voltage pulse according to IEC 60060-1

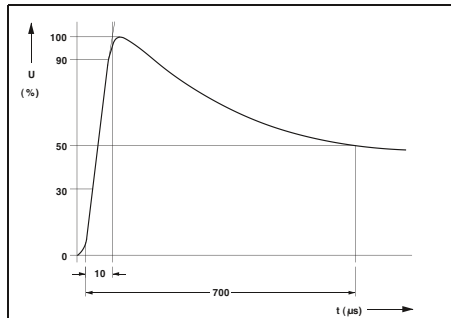

10/700 surge voltage pulse according to ITU-T K.44

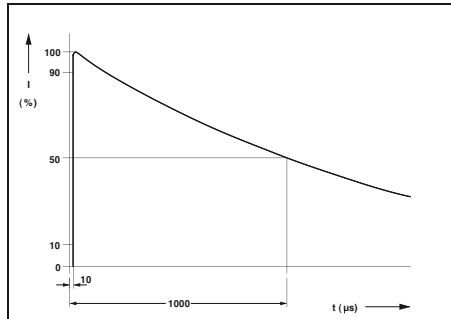

10/1000 surge current pulse according to IEEE C62.41.1

**Switching surge voltage**

Surge voltage as a result of a switching operation.

**Symmetrical interference**

As shown in the figure, the disturbance variable moves from the source along one conductor to the potentially susceptible equipment and back along the other conductor. The terms “normal-mode interference” or “differential mode” are also used.

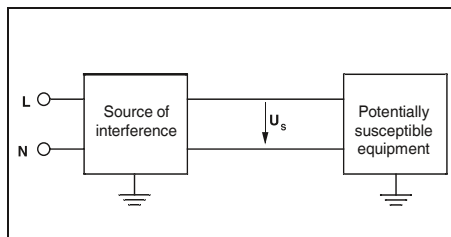

**Symmetrical interference voltage**

Interference voltage between two wires of a cable (e.g., double cable) or between two connection points of electrical equipment for this cable type.

**Symmetrical voltage, differential mode voltage**

Voltage between two live conductors from one defined group.

**Temperature range**

Range between the minimum and maximum temperature that may be present at/in housing. For devices without self-heating, this value is the permissible ambient temperature. For devices with self-heating, these values are the maximum temperatures that may occur at/in the device during operation.

**To ground**

An electrically conductive part, e.g., the lightning protection system is connected to ground via a grounding system.

**Transient**

Describes a phenomenon or variable which changes during what is, in comparison to the time scale being observed, a short period of time between two consecutive stationary states.

**Transients**

Irregular and relatively short positive and/or negative voltage or current changes between two stationary states.

**Varistors**

A varistor is a bipolar non-linear resistor with a symmetrical voltage/current characteristic curve and a resistance value which decreases as the voltage increases.

## Quality in quantity

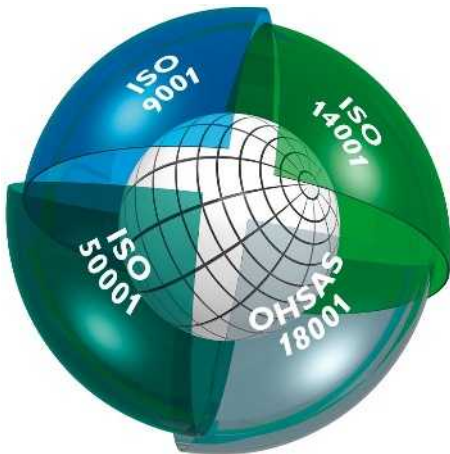

### Integrated management system

The aim of the Phoenix Contact integrated management system is to coordinate all the requirements regarding products, processes, and organization.

Statutory and regulatory requirements, as well as those of international standards and our customers, are met and, in some cases, even exceeded in all phases of the product lifecycle.

The Phoenix Contact management system is monitored by internationally recognized independent bodies each year to ensure that quality, environmental protection, energy efficiency, and occupational safety have been integrated in conformance with the relevant requirements. Certification in accordance with international standards ISO 9001, ISO 14001, ISO 50001, and BS OHSAS 18001 is the result of our corporate philosophy of meeting the needs of our customers, staff, and environment as best as possible. They serve as the basis for innovative products with the familiar high Phoenix quality standard, actively practiced environmental protection through efficient production and products that conserve resources, and responsibility in the field of occupational health and safety. It goes without saying that we integrate all further requirements of standards, international approvals or special customer requirements into our company processes.

This system provides a building block for the success of the Phoenix Contact Group and its products and services.

### CE marking

CE marking was introduced as an important instrument for the free movement of goods and services within the single European market. By attaching the mark to a product, the manufacturer confirms that it complies with all applicable European Union (EU) directives. EC directives describe the product properties with regard to device safety and avoiding danger. These are legally binding regulations of the European Union (EU). In other words, compliance with the requirements is a **statutory condition for**

### marketing the product within the EU.

Where applicable, the products that our company currently manufactures fall within the scope of the following directives:

- 2006/95/EC and 2014/35/EU  
Electrical equipment designed for use within certain voltage limits (Low-Voltage Directive)
- 2004/108/EC and 2014/30/EU  
Electromagnetic compatibility (EMC Directive)
- 2004/22/EC and 2014/32/EU  
Measuring instruments
- 2006/42/EC  
Safety of machinery (Machinery Directive)
- 94/9/EC and 2014/34/EU  
Equipment and protective systems intended for use in potentially explosive areas (ATEX Directive)
- 1999/5/EC  
R&TTE Directive and 2014/53/EU  
Radio Equipment Directive

The standards upon which the specified directives are based have been part of our standard of development for a long time. This guarantees conformance with European directives. The numbers of the directives indicate their version at the time of publication. In the event of changes to directives and/or standards, our products will undergo conformity assessment again in good time and a new declaration of conformity will be issued promptly. The current declarations for each product can also be found in our download area.

The EMC Directive occupies a special place among the European directives listed. It defines electromagnetic compatibility as a fundamental property of devices based on mandatory guidelines. European Law therefore acknowledges the electromagnetic compatibility of devices and systems as an important condition for error-free operation of machinery and systems. Phoenix Contact is one of the leading international companies in surge protection, and therefore possesses broad expertise in EMC. This expertise and the experience gained over years of developing and applying industrial interface and communication technology have resulted in our products having an extremely high standard of quality with regard to electromagnetic compatibility. It was with a view to providing other companies with this expertise that our associate company, Phoenix Testlab, was founded. Phoenix Testlab GmbH is an independent, accredited service provider offering EMC testing that conforms to European standards. At Phoenix Testlab, devices are also tested with regard to their electrical safety, mechanical influences, and their behavior in relation to environmental influences. Furthermore, Phoenix Testlab is a “Notified Body” in

accordance with EMC Directive 2004/108/EC and according to R&TTE Directive 1999/5/EC for radio and telecommunications terminal equipment. As a “Telecom Certification Body” (TCB), Phoenix Testlab may also approve these products for markets in the USA, Canada, and Japan.

### Standards and regulations

All relevant standards and regulations are used as the basis for the development and maintenance of our products.

International standards are subject to continuous changes as a result of harmonization and new developments. In line with this process, the current version of all standards that are relevant to our products is documented in the product area on our website at

[www.phoenixcontact.net/products](http://www.phoenixcontact.net/products).

### Online product information service on the web

Phoenix Contact's product range is growing constantly.

Due to our commitment to product monitoring, all products are subject to improvement.

The Internet is an ideal platform to quickly communicate new product developments and improvements to the market.

You can quickly access the relevant Phoenix Contact website for your region via [www.phoenixcontact.com](http://www.phoenixcontact.com). Here, you will always find the latest overview of products, solutions, and services from Phoenix Contact. This includes technical documents, such as data sheets and user manuals, the latest driver and demo software, plus a means of contacting the appropriate contact person directly.

## Shock protection

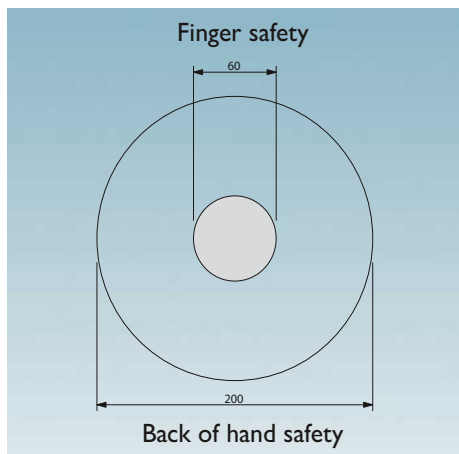

Example: pressure actuation



Finger safety



Back of hand safety

The accident prevention regulations BGV A 2 issued by the German employer's liability insurance association for precision mechanics and electrical engineering apply to the operators of electrical systems and are aimed at the prevention of electrical accidents by means of special safety requirements.

These regulations contain specifications regarding the safety distances for work, operation, and occasional handling in the proximity of "live parts" in low-voltage systems up to 1000 V ~ or 1500 V –.

- Work with live parts is only permitted once they have been de-energized.

Operational activities are only permitted in the vicinity of live parts if these parts are de-energized or are protected against direct contact (§ 6). The following safety measures apply when working in the vicinity of live parts:

- Provision of the de-energized state for the duration of the work
- Ensure shock protection is in place in the form of covers or barriers during the work
- Assurance that the permitted proximity limits will not be violated (§ 7).

The term "occasional handling" has been introduced for the operation of elements such as pushbuttons, rocker arms or rotary buttons in the proximity of live parts.

According to VDE 0105-1, this is covered by "operation with partial protection against direct contact".

Detailed specifications for "occasional handling" can be found in DIN VDE 0106-100. This specifies to what degree live parts in the proximity of operating elements are to be protected against contact. The basis for this is the definition of a "protection area for occasional handling"; this is the area into which the user must reach in order to handle the

machine.

The most important thing is that an area formed by an even envelope curve 30 mm in radius must surround the live parts. This area must be **touch proof**, i.e., the live parts of the electrical device must not be within reach of the VDE test finger according to IEC 60529/DIN VDE 0470-1 (test finger).

Back of hand safety is specified for the "rest of the area" up to 100 mm around the operating element. **Back of hand safety** means that when a force of 50 N is applied to a ball with a diameter of 50 mm, this does not come into contact with the live parts of the equipment. No special measures for ensuring contact safety are stipulated outside this area.

Note: systems and equipment that are operated with SELV up to 25 V ~ or 60 V – are considered to be protected against "direct contact".

According to § 5, Subsection 4 of the BGV A 2 regulations, there is no need to test the condition of the system prior to initial startup if the company has confirmation from the manufacturer or installer that the electrical systems and equipment conform to BGV A 2. The confirmation required relates to systems and equipment that have been installed and are ready for operation and can only be issued by the installer or installation company. The manufacturer of the electrical equipment can only issue a confirmation that products have been produced in accordance with the relevant electrotechnical DIN VDE regulations stipulated in BGV A 2. The installer must bear this in mind when selecting the equipment to be used.

In the field of connection technology, Phoenix Contact offers a wide range of products that are touch proof or that can be protected against contact using covers.

Depending on the conditions, all of this must be taken into account when selecting the individual types of terminal block and accessories.

## Quality features of insulating housing

### Thermoplastics

The majority of our insulating housing is made from thermoplastic materials. Roughly speaking, these can be divided into amorphous and semi-crystalline substances. Thermoplastics are processed using the efficient and environmentally-friendly injection molding process. They have good recycling properties and can be re-used. We use many materials that are modified in different ways to meet the demanding requirements that electrical and electronic modules, devices, and systems have to meet with regard to their mechanical, thermal, and electrical properties.

### Behavior of plastics under the influence of temperature (operating temperatures, mechanical influences)

All plastics undergo a process referred to as thermal aging when they are subjected to heat over long periods. This process causes changes in the mechanical and electrical properties of the material. External influences, e.g., radiation, additional mechanical, chemical or electrical stresses, amplify this effect. Special tests on samples can yield characteristic data which provides a good means of drawing comparisons between different plastics. However, applying these characteristics to an evaluation of molded plastic parts is only possible to a limited extent, and can only give the designer a rough guide when it comes to selecting a plastic material. This catalog uses the following assessment criteria: the **RTI value** according to UL746B/ANSI 746 B (elec. based on electric strength) and the **Ti value** according to IEC 60216-1 (based on a 50% reduction in tensile strength after 20,000 hours).

IEC 60947-7-1/EN 60947-7-1 specifies a permissible temperature increase of 45 K for terminal blocks under nominal load. Phoenix Contact terminal blocks meet this requirement.

The properties of plastics are not only affected by the influence of heat as described above; they also undergo changes as a result of cold influences. When subjected to cold as well as low levels of humidity, plastics become increasingly brittle with the result that they are no longer capable of withstanding the same mechanical loads. As the table on the right shows, the plastics concerned can be used down to a temperature of  $-40^{\circ}\text{C}$ , but only without a mechanical load. As far as the products presented in the catalog are concerned, it is the ambient temperature specified in each case that is to be regarded as definitive for operation. Regardless of the plastics used, this may be subject to further restrictions (e.g., limited to  $-20^{\circ}\text{C}$ ) as a result of the components used or other restrictive

parameters.

At very low temperatures, this means that any form of mechanical load on the plastic components must be avoided (e.g., mounting of products on/removal of products from the DIN rail, actuation of terminal points, locking/ejection of relays from bases, prizing out of jumpers, bending of cables and lines, etc.), as there is always an associated risk of damage. Unless otherwise indicated, it is recommended that you carry out the specified mounting/operational tasks in a temperature range from  $-10^{\circ}\text{C}$  to  $+40^{\circ}\text{C}$ .

### Inflammability characteristics of plastics (UL 94)

The inflammability tests for plastics have been defined by the Underwriters Laboratory (USA) in regulation UL 94. This applies to all usage ranges, but in particular to electrical engineering. A horizontal or vertical test is carried out at the test laboratory to determine the inflammability of the plastic material with a naked flame. In order of increasing flame-retardant behavior, the evaluation classes are HB, V2, V1, V0, and 5V. Test results are recorded on "yellow cards" and are published annually in the **Recognized Component Directory**.

### Thermoplastics: non-reinforced polyamide, PA

We use the modern, semi-crystalline polyamide insulation material, which has now become an essential component in electrical engineering and electronics. It has long occupied a leading position and is authorized for use by the relevant approval authorities such as the CSA, NEMKO, KEMA, PTB, SEV, UL, VDE, etc.

Polyamide also has excellent electrical, mechanical, chemical, and other properties, even at high operating temperatures. Brief peak temperatures up to approximately  $200^{\circ}\text{C}$  are permitted as a result of heat aging stabilization. Depending on the type (PA 4.6, 6.6, 6.10, etc.), its melting point is in the region of  $215^{\circ}\text{C}$  to  $295^{\circ}\text{C}$ .

Polyamide absorbs moisture from its surroundings, on average 2.8%. However, this moisture is not in the form of crystallization water in the plastic itself, but chemically bonded  $\text{H}_2\text{O}$  groups in the molecule structure. This makes the plastic flexible and resistant to breakage, even at temperatures as low as  $-40^{\circ}\text{C}$ . According to UL 94, PA belongs to inflammability class V2 to V0.

### Thermoplastics: polyester, PBT

We use the semi-crystalline thermoplastic polyester in non-reinforced and fiberglass-reinforced variants for special applications which require increased dimensional and form stability.

In addition to the high operating temperature, the material is characterized by excellent mechanical strength and hardness, and does not absorb moisture from its surroundings. PBT is therefore particularly suitable for strips, for example, which are soldered onto PCBs and subsequently have to pass a burn-in test while they are subjected to heat. According to UL 94, PBT belongs to inflammability class V2 to V0.

### Thermoplastics: polycarbonate, PC

Polycarbonate combines many advantages such as rigidity, impact strength, transparency, dimensional stability, good insulation properties, and resistance to heat.

This amorphous material only absorbs moisture to a very limited degree, and is used for items such as large, rigid electronic component housing.

In its transparent form, polycarbonate is particularly suitable for use as a material for cover profiles or marking materials.

PC has good resistance properties against mineral acids, saturated aliphatic hydrocarbons, gasoline, greases, and oils.

The material is less resistant to solvents, benzene, lyes, acetone, and ammonia. Strain cracks may result from contact with certain chemicals.

According to UL 94, PC belongs to inflammability class V2 to V0.

### Thermoplastics: polycarbonate fiber-reinforced, PC-F

Compared to non-reinforced materials, fiber-reinforced polycarbonates feature greater rigidity, impact strength, and operating temperature. In other respects, their properties are largely identical to those of non-reinforced polycarbonate.

### Thermoplastics: ABS

We use the thermoplastic molding compound ABS for products which must have good impact and notched impact properties in addition to high mechanical stability and rigidity. The products are resistant to chemicals and stress cracking due to their special surface quality and hardness.

The characteristic thermal properties provide good dimensional stability at both low and high temperatures. Products made from ABS can be coated with metallic surfaces, e.g., nickel.

The inflammability class of the molding compound used is HB to V0 according to UL 94.

Properties	Unit/level	Polyamide PA	Polyester PBT	Polycarbonate PC	Polycarbonate PC-F	ABS
Operating temperature RTI */**	°C	≤ 105	≤ 105	≤ 125	≤ 120	≤ 80
Minimum temperature (without mechanical load)	°C	-40	-40	-40	-40	-40
Electric strength acc. to IEC 60243-1/DIN VDE 0303-21	kV/cm	600	400	> 300		850
Resistance to creepage IEC 60112/DIN VDE 0303-1	CTI...M	550	225	175		200
	CTI...	600	225	175	175	600
Tropical and termite resistance		Good	Good	Good		
Specific contact resistance IEC 60093/VDE 0303 Part 30; IEC 60167/VDE 0303 Part 31	Ω cm	10 <sup>12</sup>	10 <sup>16</sup>	> 10 <sup>16</sup>	> 10 <sup>14</sup>	10 <sup>14</sup>
Surface resistance IEC 60093/VDE 0303 Part 30; IEC 60167/VDE 0303 Part 31	Ω	10 <sup>10</sup>	10 <sup>13</sup>	> 10 <sup>14</sup>		10 <sup>13</sup>
Inflammability class according to UL 94		V2-V0	V0	V2-V0	V0	HB - V0

\* According to UL 746 B/ANSI 746 B (elec.)

\*\* Minimum value

### Dimensions

**Dimensions: Width/Height/Depth**



The dimensions "**Width/Height/Depth**" are defined as follows for all DIN-rail-mountable products in the INTERFACE range:

- **Width:** measurement taken along the DIN rail
- **Height:** measurement taken across the DIN rail
- **Depth:** measurement taken starting from the mounting plate and including the NS 35/7,5 DIN rail (EN 60715)

The width, height, and depth never change, even if the products shown in this catalog happen to be photographed from two different perspectives (horizontal or vertical).

To make things easier for you, one of the following two symbols has been included next to each product photo:

### EMC: Class A product:

In accordance with statutory regulations, our products are indicated with this footnote if they are intended for use in industrial environments. This means that the permitted limit values for residential applications may be exceeded in the event of conducted and emitted disturbance variables. In such cases, the operator may have to take additional safety measures in order to ensure electromagnetic compatibility in residential applications.

### Note:

Subject to changes that serve the purpose of technical progress.

## Connection cross section

The rated cross section of terminal blocks must be specified by the manufacturer according to IEC 60947-7-1. The rated cross section is the maximum conductor cross section that can be connected in single, multi or fine-strand versions subject to specific thermal, mechanical, and electrical requirements.

The manufacturer must also specify the **rated connection capacity**, i.e., the area of the conductor that can be connected, as well as the number of conductors that can be connected simultaneously and the necessary preparation of the conductor ends. The conductors can be **solid (single or multi-**

**strand) or stranded (fine-strand).**

These values can be found in the product-specific technical data.

The rated connection capacity of Phoenix Contact terminal blocks usually exceeds standard requirements, which specify that it must only be possible to connect one conductor with one of the two next smallest cross sections, excluding the rated cross section (standardized for the cross section range from 0.2 to 35 mm<sup>2</sup>).

In addition, conductors with a rated cross section can usually be wired with ferrules with plastic sleeve.

Phoenix Contact terminal blocks are

designed to allow copper cables to be connected to them without any special treatment. "Special treatment" or the use of ferrules – both permitted according to IEC 60947-7-1 – are not required. If ferrules are nevertheless used to protect stranded conductors against splicing, the connection capacity of the stranded conductor is generally reduced by one level.

## Structure and dimensions of connecting cables

Cross section [mm <sup>2</sup> ]	Single-strand		Multi-strand		Fine-strand		Gauge No. AWG	American Wire Gauge [AWG]					
	Diameter max. dimension	Number of wires	Diameter max. dimension	Number of wires (minimum number)	Diameter max. dimension	Number of wires (guide value)		Solid wires			Stranded wires		
								[Ø mm]	[circ. mils]	[mm <sup>2</sup> ]	[Ø mm]	[circ. mils]	[mm <sup>2</sup> ]
0.2	0.5	1	–	–	–	–	24	0.51	404	0.21	–	–	–
0.5	0.9	1	1.1	7	1.1	16	20	0.81	1022	0.52	0.97	1111	0.56
0.75	1.0	1	1.2	7	1.3	24	18	1.02	1620	0.82	1.16	1600	0.82
1	1.2	1	1.4	7	1.5	32	(17)	1.15	2050	1.04	–	–	–
–	–	–	–	–	–	–	16	1.29	2580	1.31	1.50	2580	1.32
1.5	1.5	1	1.7	7	1.8	30	(15)	1.45	3260	1.65	–	–	–
–	–	–	–	–	–	–	14	1.63	4110	2.08	1.85	4100	2.09
2.5	1.9	1	2.2	7	2.3	50	(13)	1.83	5180	2.63	–	–	–
–	–	–	–	–	–	–	12	2.05	6530	3.31	2.41	6500	3.32
4	2.4	1	2.7	7	2.9	56	(11)	2.30	8230	4.17	–	–	–
–	–	–	–	–	–	–	10	2.59	10380	5.26	2.95	10530	5.37
6	2.9	1	3.3	7	3.9	84	(9)	2.91	13100	6.63	–	–	–
–	–	–	–	–	–	–	8	3.26	16510	8.37	3.73	16625	8.48

## Tightening torque of terminal block screws

IEC 60947-1/EN 60947-1, modified, Table 4 specifies tightening torques for screw connections based on the screw size for electrical and mechanical type tests.

### Extract from IEC 60947-1/EN 60947-1, Table 4

The torque according to IEC and the recommended torque for Phoenix Contact terminal blocks are specified

Thread	Head screw with slot	
	Torque	Recommended tightening torque
	[Nm]	[Nm]
M2.5 (M2.6)	0.4	0.4-0.5
M3	0.5	0.5-0.6
M3.5	0.8	0.8-1.0
M4	1.2	1.2-1.5

## Current carrying capacity

















































Standard IEC 60947-7-1/EN 60947-7-1/DIN VDE 0611-1 specifies the test currents for the individual conductor cross sections listed in the adjacent table. The corresponding currents are listed with the connection data for the individual terminal blocks. The type tests of terminal blocks are based on this data.

### Test currents according to IEC 60947-7-1/EN 60947-7-1, Table 5

Rated cross section	[mm <sup>2</sup> ]	0.2	0.5	0.75	1.0	1.5	2.5	4	6	10	16
Test current	[A]	4	6	9	13.5	17.5	24	32	41	57	76



## Certification bodies and safety marks

Certification bodies and approvals	Country code	 Explosion protection	Country code	Ship classification societies	Country code
 IECCEB CB Scheme (in combination with certifying body)	Intl.	 International Electrotechnical Commission	Intl.	 Bureau Veritas	FR
 CENELEC Certification Agreement (CCA inspection report) (in combination with certifying body)	EU	 DEKRA Certification B.V.	NL	 Germanischer Lloyd AG	DE
 Canadian Standards Association (CSA)	CA	 Physikalisch-Technische Bundesanstalt	DE	 Lloyd's Register of Shipping	GB
 Canadian Standards Association (CSA) - CSA approval for the USA -	US	 KIWA Nederland B.V.	NL	 Nippon Kaiji Kyokai	JP
 Canadian Standards Association. (CSA) Combined logo - CSA approval for Canada and the USA -	CA US	 QS Schaffhausen AG	CH	 Det Norske Veritas	NO
 Underwriters Laboratories Inc. (UL)	US	 VTT Expert Services Oy	FI	 Polski Rejestr Statków	PL
 Underwriters Laboratories Inc. (UL) - UL approval for Canada -	CA	 IBEXU Institut für Sicherheitstechnik GmbH	DE	 Russian Maritime Register of Shipping	RU
 Underwriters Laboratories Inc. (UL) Combined logo - UL approval for the USA and Canada -	US CA	 TÜV Rheinland do Brasil	BR	 Korean Register of Shipping	KR
 INSIEME PER LA QUALITA'E LA SICUREZZA	IT	 Technischer Überwachungsverein Nord	DE	 American Bureau of Shipping	US
 Eurasian Conformity	BY KZ RU	 DEKRA EXAM GmbH	DE		
 DEKRA Certification B.V.	NL	 Canadian Standards Association (CSA)	CA		
 Österreichischer Verband für Elektrotechnik	AT	 Canadian Standards Association (CSA) - CSA approval for the USA -	US		
 electrosuisse SEV Verband für Elektro-, Energie- und Informationstechnik	CH	 Canadian Standards Association. (CSA) Combined logo - CSA approval for Canada and the USA -	CA US		
 Verband Deutscher Elektrotechniker e.V. (VDE) - Approval of drawings - Reports with production monitoring	DE	 Underwriters Laboratories Inc. (UL)	US		
 Berufsgenossenschaft (BG) GS - Geprüfte Sicherheit	DE	 Underwriters Laboratories Inc. (UL) - UL approval for Canada -	CA		
 Intertek ETL Listed - Approval for the USA -	US	 Underwriters Laboratories Inc. (UL) Combined logo - UL approval for the USA and Canada -	US CA		
 Intertek ETL Listed - Approval for Canada -	CA	 FM Approvals	US		
 Intertek ETL Listed - Approval for the USA and Canada -	US CA	 Eurasian Conformity for Ex-products	BY KZ RU		
 TÜV Rheinland Industrie Service GmbH	DE				
 China Compulsory Certificate	CN				

## Dimensioning of clearances

### Schematic for determining clearances

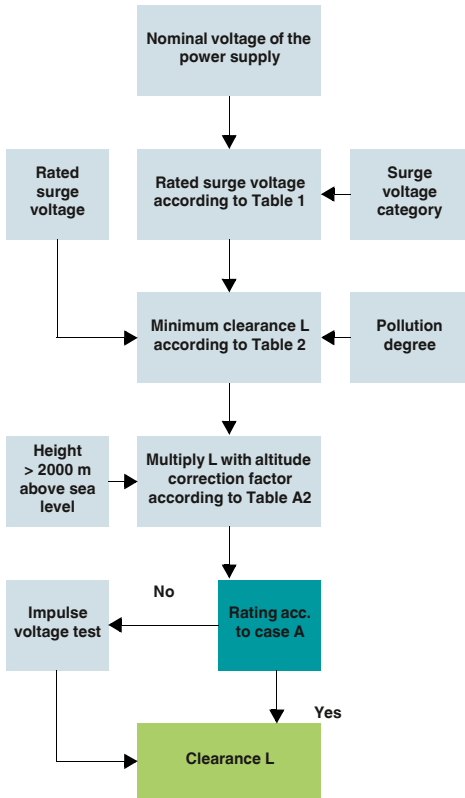

### Rated surge voltages for equipment that is directly supplied by the low-voltage network (extract from Table 1)

Nominal voltage of the power supply system 1) (mains acc. to IEC 60038 3)		Conductor-neutral conductor voltage derived from the total nominal AC voltage or nominal DC voltage	Rated surge voltage 2) [V]			
Three-phase [V]	Single-phase [V]		Surge voltage category 4)			
		[V]	I	II	III	IV
		50	330	500	800	1500
		100	500	800	1500	2500
		150	800	1500	2500	4000
230/400	277/480	300	1500	2500	4000	6000
		600	2500	4000	6000	8000
		1000	4000	6000	8000	12000

1) Refer to Annex B for application in existing deviating low-voltage networks and their nominal voltages.

2) Equipment with this rated surge voltage may be used in systems according to IEC 60364-4-443.

3) The slash, i.e., /, indicates a three-phase four-conductor system. The lower value is the conductor-to-neutral conductor voltage, whereas the higher value is the conductor-to-conductor voltage. When only one value is specified, it refers to a three-phase three-conductor system, and indicates the conductor-to-conductor voltage.

4) Refer to 2.2.2.1.1 for an explanation of surge voltage categories.

### Minimum clearances for surge voltages (extract from Table 2)

Required rated impulse voltage 1) 5) [kV]	Condition A Non-homogeneous field (refer to 3.15)			Condition B Homogeneous field (refer to 3.14)		
	Pollution degree 6)					
	1 [mm]	2 [mm]	3 [mm]	1 [mm]	2 [mm]	3 [mm]
0.33 2)	0.01	0.2 3) 4)	0.8 4)	0.01	0.2 3) 4)	0.8 4)
0.40	0.02			0.02		
0.5 2)	0.04			0.04		
0.60	0.06			0.06		
0.80 2)	0.10			0.10		
1.0	0.15			0.15		
1.2	0.25	0.25		0.2		
1.5 2)	0.5	0.5		0.3	0.3	
2.0	1.0	1.0	1.0	0.45	0.45	
2.5 2)	1.5	1.5	1.5	0.6	0.6	
3.0	2.0	2.0	2.0	0.8	0.8	
4.0 2)	3	3	3	1.2	1.2	1.2
5.0	4	4	4	1.5	1.5	1.5
6.0 2)	5.5	5.5	5.5	2	2	2
8.0 2)	8	8	8	3	3	3
10	11	11	11	3.5	3.5	3.5
12 2)	14	14	14	4.5	4.5	4.5
15	18	18	18	5.5	5.5	5.5
20	25	25	25	8	8	8
25	33	33	33	10	10	10
30	40	40	40	12.5	12.5	12.5
40	60	60	60	17	17	17
50	75	75	75	22	22	22
60	90	90	90	27	27	27
80	130	130	130	35	35	35
100	170	170	170	45	45	45

1) This voltage is:

- For function insulation: the highest surge voltage expected for the clearance
- For basic insulation, if influenced directly or considerably by surge voltages from the low-voltage network: the rated surge voltage of the equipment
- For a different basic insulation: the highest impulse voltage possible in the circuit

2) Preferred values

3) For PCBs, the values of pollution degree 1 are applicable, except that no deviation below the value of 0.04 mm is permitted, as specified in Table 4.

4) Minimum clearances for pollution degrees 2 and 3 are based on the corresponding creepage distances. This resistance is reduced due to the effects of humidity.

5) Values can be interpolated for parts or circuits within equipment that are subjected to impulse voltages.

6) The distances for pollution degree 4 are equal to those for pollution degree 3, except that the minimum clearance is 1.6 mm.

### Altitude correction factors (extract from Table A.2)

Height in m	Normal air pressure in kPa	Multiplication factor for gaps
2000	80.0	1.00
3000	70.0	1.14
4000	62.0	1.29
5000	54.0	1.48
6000	47.0	1.70
7000	41.0	1.95
8000	35.5	2.25
9000	30.5	2.62
10000	26.5	3.02
15000	12.0	6.67
20000	5.5	14.50

## Dimensioning of creepage distances

### Schematic for determining creepage distances

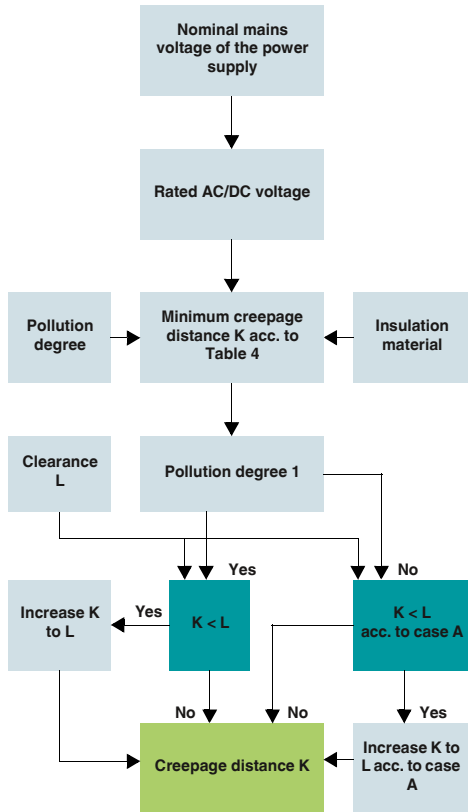

Nominal voltage of the power supply system (mains) <sup>*)</sup>	Voltages for Table 4	
	for conductor-conductor insulation <sup>1)</sup>	for conductor-ground insulation <sup>1)</sup>
	All systems	Three-conductor systems center point grounded
[V]	[V]	[V]
12.5	12.5	-
24	25	-
30	32	-
42	-	-
48	50	-
50 <sup>**)</sup>	-	-
60	63	-
30-60	63	32
100 <sup>**)</sup>	100	-
110	-	-
120	125	-
150 <sup>**)</sup>	160	-
220	250	-
110-220	-	125
220-240	250	-
300 <sup>**)</sup>	320	-
220-440	500	250
600 <sup>**)</sup>	630	-
480-960	1000	500
1000 <sup>**)</sup>	1000	-

<sup>1)</sup> Conductor-ground insulation levels for non-grounded systems or those grounded through impedance correspond to conductor-conductor insulation levels as the operating voltage of every conductor to ground can, in practice, reach the conductor-conductor voltage. This is due to the fact that the actual voltage to ground is determined by the insulation resistance and the capacitive reactance of each conductor to ground. A low (but permissible) insulation resistance of one conductor can thereby practically ground it and increase the other two to conductor-conductor voltage to ground.

<sup>\*)</sup> Refer to 2.2.1 for correlation with the rated voltage.  
<sup>\*\*)</sup> These values correspond to the values in Table 1.

Nominal voltage of the power supply system (mains) <sup>*)</sup>	Voltages for Table 4		
	for conductor-conductor insulation	Insulation for conductor-ground	
	All systems	Three-phase four-conductor systems with grounded neutral conductor <sup>2)</sup>	Three-phase three-conductor systems non-grounded <sup>1)</sup> or conductor grounded
[V]	[V]	[V]	[V]
60	63	32	63
110/120/127	125	80	125
150 <sup>**)</sup>	160	-	160
208	200	125	200
220/230/240	250	160	250
300 <sup>**)</sup>	320	-	320
380/400/415	400	250	400
440	500	250	400
480/500	500	320	500
575	630	400	630
600 <sup>**)</sup>	630	-	630
660/690	630	400	630
720/830	800	500	800
960	1000	630	1000
1000 <sup>**)</sup>	1000	-	1000

<sup>1)</sup> Conductor-ground insulation levels for non-grounded systems or those grounded through impedance correspond to conductor-conductor insulation levels as the operating voltage of every conductor to ground can, in practice, reach the conductor-conductor voltage. This is due to the fact that the actual voltage to ground is determined by the insulation resistance and the capacitive reactance of each conductor to ground. A low (but permissible) insulation resistance of one conductor can thereby practically ground it and increase the other two to conductor-conductor voltage to ground.

<sup>2)</sup> For equipment designed for use in three-phase four-conductor and three-phase three-conductor systems, grounded as well as non-grounded, only the values for three-conductor systems may be used.

<sup>\*)</sup> Refer to 2.2.1 for correlation with the rated voltage.  
<sup>\*\*)</sup> These values correspond to the values in Table 1.

### Creepage distances to prevent failures occurring due to creepage (extract from Table 4)

Voltage <sup>1)</sup> r.m.s. value	Minimum creepage distances											
	Printed circuits			Pollution degree								
	Pollution degree			1			2			3		
	All insulation material groups	All insulation material groups except IIb	All insulation material groups	Insulation material group			Insulation material group					
[V]	[mm]	[mm]	[mm]	I [mm]	II [mm]	III [mm]	I [mm]	II [mm]	III <sup>2)</sup> [mm]			
10	0.025	0.04	0.08	0.40	0.40	0.40	1.00	1.00	1.00			
12.5	0.025	0.04	0.09	0.42	0.42	0.42	1.05	1.05	1.05			
16	0.025	0.04	0.10	0.45	0.45	0.45	1.10	1.10	1.10			
20	0.025	0.04	0.11	0.48	0.48	0.48	1.20	1.20	1.20			
25	0.025	0.04	0.125	0.50	0.50	0.50	1.25	1.25	1.25			
32	0.025	0.04	0.14	0.53	0.53	0.53	1.30	1.30	1.30			
40	0.025	0.04	0.16	0.56	0.80	1.10	1.4	1.6	1.8			
50	0.025	0.04	0.18	0.60	0.85	1.20	1.5	1.7	1.9			
63	0.040	0.63	0.20	0.63	0.90	1.25	1.6	1.8	2.0			
80	0.063	0.10	0.22	0.67	0.95	1.3	1.7	1.9	2.1			
100	0.10	0.16	0.25	0.71	1.00	1.4	1.8	2.0	2.2			
125	0.16	0.25	0.28	0.75	1.05	1.5	1.9	2.1	2.4			
160	0.25	0.40	0.32	0.80	1.1	1.6	2.0	2.2	2.5			
200	0.40	0.63	0.42	1.00	1.4	2.0	2.5	2.8	3.2			
250	0.56	1.00	0.56	1.25	1.8	2.5	3.2	3.6	4.0			
320	0.75	1.60	0.75	1.60	2.2	3.2	4.0	4.5	5.0			
400	1.00	2.00	1.00	2.00	2.8	4.0	5.0	5.6	6.3			
500	1.30	2.50	1.30	2.50	3.6	5.0	6.3	7.1	8.0			
630	1.80	3.20	1.8	3.2	4.5	6.3	8.0	9	10.0			
800	2.40	4.00	2.4	4.0	5.6	8.0	10.0	11	12.5			
1000	3.20	5.00	3.2	5.0	7.1	10	12.5	14	16.0			
1250			4.2	6.3	9	12.5	16	18	20			
1600			5.6	8	11	16	20	22	25			
2000			7.5	10	14	20	25	28	32			
2500			10	12.5	18	25	32	36	40			
3200			12.5	16	22	32	40	45	50			
4000			16	20	28	40	50	56	63			
5000			20	25	36	50	63	71	80			
6300			25	32	45	63	80	90	100			
8000			32	40	56	80	100	110	125			
10000			40	50	71	100	125	140	160			

<sup>1)</sup> This voltage is:  
a) For function insulation: the working voltage  
b) For basic and additional insulation of a circuit supplied directly by the low-voltage network: either the voltage selected from Table 3a or 3b on the basis of the rated voltage of the equipment or the rated insulation voltage;  
c) For basic and additional insulation of systems, equipment, and internal circuits which are not supplied directly from the mains: the highest r.m.s. value of the voltage that, within the bounds of the rated data, can occur in the system, the equipment or the internal circuit, when supplied with rated voltage and in the case of the most unfavorable combination of operating conditions.

<sup>2)</sup> With pollution degree 3, insulation material group IIb is not recommended for use if voltages are greater than 630 V.

# Index

## Alphabetical

Type	Order No.	Page	Type	Order No.	Page	Type	Order No.	Page	Type	Order No.	Page
<b>A</b>			CB TM1 16A M1 P	2800856	254	CSMA-LAMBDA/4-2.0-BS-SET	2800491	129	ECP 6	0912033	267
			CB TM1 16A SFB P	2800845	253	CT 1-10-ES	2765547	119	ECP1-2	0912018	267
			CB TM1 1A F1 P	2800858	255	CT 10-2/2-GS	2765398	118	ECP10	0912020	267
			CB TM1 1A M1 P	2800847	254	CT 10-2/2-GS/3E	2765408	118	ECP2	0911034	267
ADAPTER KOAX TYP F	2880972	130	CB TM1 1A SFB P	2800836	215	CT 10-2/2-GS/3E-110AC	2920829	118	ECP3	0911047	267
<b>B</b>			CB TM1 2A F1 P	2800859	255	CT 10-MB/ 3	2765372	119	ECP3-6	0916536	267
			CB TM1 2A M1 P	2800848	254	CT 10-MB/10	2765385	119	ECP8	0912019	267
			CB TM1 2A SFB P	2800837	215	CT 10-TL	2765356	119	ECP-E 1A	0900113	266
			CB TM1 3A F1 P	2800860	255	CT-KDT	2765518	119	ECP-E 2A	0900210	266
BATTERY MOUNTING CASE	2320458	231	CB TM1 3A M1 P	2800849	254	CT-TERMBLOCK 10 DA	0441711	119	ECP-E 3A	0900317	266
BATTERY MOUNTING KIT	2320788	231	CB TM1 3A SFB P	2800838	215	CTM 10-MAG	2838610	119	ECP-E 4A	0900414	266
BLT-T2-1S-320-UT	2906101	50	CB TM1 4A F1 P	2800861	255	CTM 1X2- 12DC	2838597	116	ECP-E 6A	0900618	266
BLT-T2-320-UT	2906100	50	CB TM1 4A M1 P	2800850	254	CTM 1X2- 24DC	2838513	116	ECP-E 8A	0900812	266
BNC-V 50	2805041	127	CB TM1 4A SFB P	2800839	215	CTM 1X2- 60DC	2838568	116	ECP-E 10A	0901002	266
BNC-V 75	2805070	127	CB TM1 4A M1 P	2800862	255	CTM 1X2-110AC	2838539	116	ECP-E-12A	0900126	266
BT-1S-230AC/A	2803409	55	CB TM1 5A F1 P	2800851	254	CTM 2X1- 12DC	2838584	116	ECP-E2-10A	0900100	267
BT-1S-230AC/O	2800625	55	CB TM1 5A M1 P	2800840	215	CTM 2X1- 24DC	2838500	116	ECP-E2-12A	0900207	267
<b>C</b>			CB TM1 6A F1 P	2800863	255	CTM 2X1- 60DC	2838542	116	ECP-E2-1A	0900139	267
			CB TM1 6A M1 P	2800852	254	CTM 2X1-110AC	2838526	116	ECP-E2-2A	0900236	267
			CB TM1 6A SFB P	2800841	215	CTM 2X1-180DC-GS	2838636	117	ECP-E2-3A	0900333	267
			CB TM1 8A F1 P	2800864	255	CTM 2X1-180DC-GS-P	2838623	117	ECP-E2-4A	0900430	267
C-SAT-BOX	2880561	130	CB TM1 8A M1 P	2800853	254	CTM EST	2838649	116	ECP-E2-6A	0900634	267
C-TV-SAT	2856993	131	CB TM1 8A SFB P	2800842	253	CTM ISDN	2838555	117	ECP-E2-8A	0900838	267
C-TV/HIFI	2857002	131	CB TM2 0.5A F1 P	2800890	255	D-DEK 1,5 BK	2838995	94	ECP-E3 10A	0912050	267
C-UB/E	2763701	127	CB TM2 0.5A M1 P	2800879	255	D-DEK 1,5 BU	2838982	95	ECP-E3 4A	0912044	267
C-UBF- 5DC/E 75	2763604	127	CB TM2 0.5A SFB P	2800868	253	D-LAN-19"-12	2880150	113	ECP-E3 6A	0912046	267
C-UBF-24DC/E	2782313	127	CB TM2 10A F1 P	2800898	255	D-LAN-19"-16	2880147	113	ECP-E3 8A	0912048	267
C7/16-LAMBDA/4-2.25-BB	2801060	129	CB TM2 10A M1 P	2800887	255	D-LAN-19"-16	2880147	113	EML (20XE)R	0803452	135
C7/16-LAMBDA/4-2.25-SB	2801059	129	CB TM2 10A SFB P	2800876	253	D-LAN-19"-20	2880134	113	EML (20XE)R YE	0803453	135
CB 1/10-1/10 UT-BE	2801305	252	CB TM2 12A F1 P	2800899	255	D-LAN-19"-24	2838791	113	F		
CB 1/6-2/4 PT-BE	2800929	252	CB TM2 12A M1 P	2800888	255	D-LAN-19"-4	2880176	113	F-MS 12	2817987	44
CB E1 24DC/10A S-C P	2800928	257	CB TM2 12A SFB P	2800877	253	D-LAN-19"-8	2880163	113	F-MS 12 ST	2817990	40
CB E1 24DC/10A S-R P	2800914	257	CB TM2 16A F1 P	2800900	255	D-LAN-19"-D-P	2880192	113	F-MS 12/FT	2817974	44
CB E1 24DC/10A SI-C P	2905812	257	CB TM2 16A M1 P	2800889	255	D-LAN-CAT.5-FF	2800723	109	F-MS 2200/30 ST	2805392	48
CB E1 24DC/10A SI-R P	2905805	257	CB TM2 16A SFB P	2800878	253	DK-BIC-35	2749880	134	F-MS 80 ST	2921307	49
CB E1 24DC/1A NC P	2800901	256	CB TM2 1A F1 P	2800891	255	DT-LAN-CAT.6+	2881007	108	F-MS-T1/T2 50 ST	2800191	36
CB E1 24DC/1A NO P	2800922	257	CB TM2 1A M1 P	2800880	255	DT-TELE-RJ45	2882925	114	FBS 2-6	3030336	252
CB E1 24DC/1A S-C P	2800908	257	CB TM2 1A SFB P	2800869	253	DT-TELE-SHDSL	2801593	114	FBS 2-6 BU	3036932	252
CB E1 24DC/1A SI-C P	2905806	257	CB TM2 2A F1 P	2800892	255	DT-UBF-485/BS	2920612	110	FBS 2-6 GY	3032237	252
CB E1 24DC/1A SI-R P	2905799	257	CB TM2 2A M1 P	2800881	255	DT-UBF-IB-RB0	2800056	111	FBS 3-6	3030242	252
CB E1 24DC/2A NC P	2800916	257	CB TM2 2A SFB P	2800870	253	DT-UBF-IB-RBI	2800055	111	FBS 3-6 BU	3036945	252
CB E1 24DC/2A NO P	2800902	256	CB TM2 3A F1 P	2800895	255	DT-UBF-V24/S-9-SB	2803069	109	FBS 3-6 GY	3032240	252
CB E1 24DC/2A S-C P	2800923	257	CB TM2 3A M1 P	2800882	255	DT-UBF-V24/S-SB-SET	2803072	109	FBS 4-6	3030255	252
CB E1 24DC/2A S-R P	2800909	257	CB TM2 3A SFB P	2800871	253	EC-E 0,5A DC24V	0903041	269	FBS 4-6 BU	3036958	252
CB E1 24DC/2A SI-C P	2905807	257	CB TM2 4A F1 P	2800894	255	EC-E 1A DC24V	0903042	269	FBS 4-6 GY	3032279	252
CB E1 24DC/2A SI-R P	2905800	257	CB TM2 4A M1 P	2800883	255	EC-E 2A DC24V	0903043	269	FBS 5-6	3030349	252
CB E1 24DC/3A NC P	2800917	257	CB TM2 4A SFB P	2800872	253	EC-E 3A DC24V	0903044	269	FBS 5-6 BU	3036961	252
CB E1 24DC/3A NO P	2800903	256	CB TM2 5A F1 P	2800895	255	EC-E 4A DC24V	0903045	269	FBS 5-6 GY	3032266	252
CB E1 24DC/3A S-C P	2800924	257	CB TM2 5A M1 P	2800884	255	EC-E 6A DC24V	0903046	269	FBS 20-6	3030271	252
CB E1 24DC/3A S-R P	2800910	257	CB TM2 5A SFB P	2800873	253	EC-E 8A DC24V	0903047	269	FBS 20-6 BU	3032198	252
CB E1 24DC/3A SI-C P	2905808	257	CB TM2 6A F1 P	2800896	255	EC-E 4A DC24V	0903045	269	FBS 10-6 GY	3032253	252
CB E1 24DC/3A SI-R P	2905801	257	CB TM2 6A M1 P	2800885	255	EC-E 6A DC24V	0903046	269	FBS 2-18	2801068	47
CB E1 24DC/4A NC P	2800918	257	CB TM2 6A SFB P	2800874	253	EC-E 8A DC24V	0903047	269	FBS 20-6	3030365	252
CB E1 24DC/4A NO P	2800904	256	CB TM2 8A F1 P	2800897	255	EC-E 10A DC24V	0903048	269	FBS 20-6 BU	3032208	252
CB E1 24DC/4A S-C P	2800925	257	CB TM2 8A M1 P	2800886	255	EC-E 12A DC24V	0903049	269	FBS 50-6	3032224	252
CB E1 24DC/4A S-R P	2800911	257	CB TM2 8A SFB P	2800875	253	EC-E1 0,5A	0903022	268	FBS 50-6 BU	3032211	252
CB E1 24DC/4A SI-C P	2905809	257	CBB 04 2X2RC-PT	2905238	259	EC-E1 10A	0903030	268	FBST 500 TMC-N GY	0901028	268
CB E1 24DC/4A SI-R P	2905802	257	CBB 08 2X4RC-PT	2905240	259	EC-E1 12A	0903031	268	FBST 500-PLC BU	2966692	268
CB E1 24DC/6A NC P	2800919	257	CBB 12 2X6RC-PT	2905241	259	EC-E1 1A	0903023	268	FBST 500-PLC RD	2966786	268
CB E1 24DC/6A NO P	2800905	256	CBM E4 24DC/0.5-10A NO-R	2905743	258	EC-E1 2A	0903024	268	FLT-ISR-100-EX	2905579	142
CB E1 24DC/6A S-C P	2800926	257	CBM E8 24DC/0.5-10A NO-R	2905744	258	EC-E1 3A	0903025	268	FLT-ISR-BR-11	2905580	143
CB E1 24DC/6A S-R P	2800912	257	CHECKMASTER 2	2905256	139	EC-E1 4A	0903026	268	FLT-ISR-BR-14	2905581	143
CB E1 24DC/6A SI-C P	2905810	257	CM 2-PA-CTM	2905282	139	EC-E1 6A	0903028	268	FLT-ISR-BR-18	2905582	143
CB E1 24DC/6A SI-R P	2905803	257	CM 2-PA-FLT/VAL-CP/SEC	2905283	139	EC-E1 8A	0903029	268	FLT-ISR-BR-22	2905583	143
CB E1 24DC/8A S-C P	2800927	257	CM 2-PA-PT/PLT	2905284	139	EC-E4 0,5A	0903040	268	FLT-ISR-BR-26	2905757	143
CB E1 24DC/8A S-R P	2800913	257	CM 2-PA-VAL-MS	2905285	139	EC-E4 10A	0903038	268	FLT-ISR-BR-30	2905758	143
CB E1 24DC/8A SI-C P	2905811	257	CN-LAMBDA/4-0.47-BB	2800021	128	EC-E4 12A	0903039	268	FLT-ISR-BR-33	2905759	143
CB E1 24DC/8A SI-R P	2905804	257	CN-LAMBDA/4-0.47-SB	2800022	128	EC-E4 1A	0903032	268	FLT-ISR-BR-36	2905760	143
CB PT BRIDGE	2801014	253	CN-LAMBDA/4-2.25-BB	2801057	128	EC-E4 2A	0903033	268	FLT-ISR-BR-39	2905761	143
CB S-BE	2905067	252	CN-LAMBDA/4-2.25-SB	2801056	128	EC-E4 3A	0903034	268	FLT-ISR-BR-42	2905762	143
CB TM1 0.5A F1 P	2800857	255	CN-LAMBDA/4-5.9-BB	2838490	129	EC-E4 4A	0903035	268	FLT-ISR-BR-48	2905763	143
CB TM1 0.5A M1 P	2800846	254	CN-LAMBDA/4-5.9-SB	2800023	129	EC-E4 6A	0903036	268	FLT-ISR-BR-56	2905764	143
CB TM1 0.5A SFB P	2800835	215	CN-UB-280DC-3-BB	2801050	126	EC-E4 8A	0903037	268	FLT-ISR-BR-62	2905765	143
CB TM1 10A F1 P	2800865	255	CN-UB-280DC-3-SB	2801051	126	ECP 4	0912034	267	FLT-ISR-CA-100	2905589	143
CB TM1 10A M1 P	2800854	254	CN-UB-70DC-6-BB	2803166	126						
CB TM1 10A SFB P	2800843	253	CN-UB-70DC-6-SB	2803153	126						
CB TM1 12A F1 P	2800866	255	CN-UB/E	2763691	127						
CB TM1 12A M1 P	2800855	254	CN-UB/E-BB	2817686	127						
CB TM1 12A SFB P	2800844	253	CN-UB/MP	2818135	126						
CB TM1 16A F1 P	2800867	255	CN-UB/MP-90DEG-50	2803137	126						

Type	Order No.	Page	Type	Order No.	Page	Type	Order No.	Page	Type	Order No.	Page
FLT-ISG-CA-200	2905590	143	MINI-PS-100-240AC/10-15DC/8	2866297	185	PT 2X2-12AC-ST	2838270	83	PT-IQ-2X2+F-48DC-PT	2801266	77
FLT-ISG-CA-300	2905591	143	MINI-PS-100-240AC/24DC/1.3	2866446	182	PT 2X2-12DC-ST	2838254	82	PT-IQ-2X2+F-48DC-UT	2800987	77
FLT-ISG-PL-11	2905584	143	MINI-PS-100-240AC/2X15DC/1.5/EX	2866653	185	PT 2X2-24AC-ST	2838283	83	PT-IQ-2X2+F-5DC-PT	2801260	77
FLT-ISG-PL-14	2905586	143	MINI-PS-100-240AC/24DC/2	2938730	183	PT 2X2-24DC-ST	2838228	82	PT-IQ-2X2+F-5DC-UT	2800809	77
FLT-ISG-PL-18	2905587	143	MINI-PS-100-240AC/24DC/4	2938837	183	PT 2X2-BE	2839208	82	PT-IQ-2X2-12DC-PT	2801261	76
FLT-ISG-PL-22	2905588	143	MINI-PS-100-240AC/24DC/C2LPS	2866336	183	PT 2X2-FF-ST	2800755	91	PT-IQ-2X2-12DC-UT	2800984	76
FLT-ISG-PL-26	2905584	143	MINI-PS-100-240AC/24DC/1.5/EX	2938743	185	PT 2X2-HF-5 DC-ST	2839567	91	PT-IQ-2X2-24DC-PT	2801263	76
FLT-ISG-PL-30	2905746	143	MINI-SYS-PS-100-240AC/24DC/1.5	2866983	182	PT 2X2-HF-12 DC-ST	2839570	91	PT-IQ-2X2-24DC-UT	2800980	76
FLT-ISG-PL-33	2905747	143	MNT-1 CH II	2882255	56	PT 2X2-HF-24 DC-ST	2839729	91	PT-IQ-2X2-48DC-PT	2801265	76
FLT-ISG-PL-36	2905754	143	MNT-1 D	2882206	56	PT 2XEX(I)-24DC-ST	2838225	89	PT-IQ-2X2-48DC-UT	2800986	76
FLT-ISG-PL-39	2905755	143	MNT-1 D/WH	2882213	56	PT 2XEX(I)-BE	2839279	89	PT-IQ-2X2-5DC-PT	2801259	76
FLT-ISG-PL-42	2905756	143	MNT-ISDN D	2882336	56	PT 3-HF-12DC-ST	2858043	90	PT-IQ-2X2-5DC-UT	2800807	76
FLT-SEC-H-T1-1C-264/25-FM	2801615	20	MNT-ISDN D/WH	2882349	56	PT 3-PB-ST	2858030	90	PT-IQ-2X2-EX-24DC-P	2801515	81
FLT-SEC-H-T1-264/25-P	2905968	20	MNT-NET B/F	2882226	56	PT 4+F-BE	2839415	86	PT-IQ-2X2-EX-24DC-UT	2801513	81
FLT-SEC-H-T1-3C-264/25-FM	2905871	20	MNT-TAE D	2882381	57	PT 4-5DC-ST	2839211	86	PT-IQ-3-HF+F-12DC-PT	2801289	79
FLT-SEC-P-T1-1C-350/25-FM	2905414	24	MNT-TAE D/WH	2882394	57	PT 4-12DC-ST	2839237	86	PT-IQ-3-HF+F-12DC-UT	2800995	79
FLT-SEC-P-T1-1C-440/25-FM	2905987	21	MNT-TEL B/F	2882404	57	PT 4-24AC-ST	2800078	86	PT-IQ-3-HF-12DC-PT	2801288	78
FLT-SEC-P-T1-1S-350/25-FM	2905415	23	MNT-TELE E	2882417	57	PT 4-24DC-ST	2839240	86	PT-IQ-3-HF-12DC-UT	2800786	78
FLT-SEC-P-T1-2C-350/25-FM	2905416	23	MNT-TELE S/WH	2880901	57	PT 4-BE	2839402	86	PT-IQ-3-PB+F-PT	2801287	79
FLT-SEC-P-T1-2S-350/25-FM	2905418	23	MNT-TV-SAT B/F	2882307	57	PT 4-EX(I)-24DC-ST	2839253	89	PT-IQ-3-PB+F-UT	2800994	79
FLT-SEC-P-T1-350/25-P	2905422	22	MNT-TV-SAT D	2882284	57	PT 4-EX(II)-BE	2839486	89	PT-IQ-3-PB-PT	2801286	78
FLT-SEC-P-T1-3C-350/25-FM	2905472	22	MNT-TV-SAT D/WH	2882297	57	PT 4-F-ST	2858441	88	PT-IQ-3-PB-UT	2800785	78
FLT-SEC-P-T1-3C-440/25-FM	2905988	21	MPB 18/1-57	2809238	135	PT 4X1+F-BE	2839376	83	PT-IQ-4X1+F-12DC-PT	2801270	77
FLT-SEC-P-T1-3S-350/25-FM	2905421	22				PT 4X1-5DC-ST	2838306	83	PT-IQ-4X1+F-12DC-UT	2801218	77
FLT-SEC-P-T1-440/25-P	2905989	21				PT 4X1-12AC-ST	2838348	83	PT-IQ-4X1+F-24DC-PT	2801272	77
FLT-SEC-P-T1-N/PE-350/100-FM	2905473	24				PT 4X1-12DC-ST	2838319	83	PT-IQ-4X1+F-24DC-UT	2800983	77
FLT-SEC-P-T1-N/PE-350/100-P	2905473	22				PT 4X1-24AC-ST	2838351	83	PT-IQ-4X1+F-48DC-PT	2801274	77
FLT-SEC-T1+T2-1C-350/25-FM	2905465	27				PT 4X1-24DC-ST	2838322	83	PT-IQ-4X1+F-48DC-UT	2801220	77
FLT-SEC-T1+T2-1S-350/25-FM	2905466	27	NEF 1- 1	2794123	149	PT 4X1-48AC-ST	2804856	83	PT-IQ-4X1+F-5DC-PT	2801268	77
FLT-SEC-T1+T2-2C-350/25-FM	2905467	26	NEF 1- 3	2794110	149	PT 4X1-48DC-ST	2858014	83	PT-IQ-4X1+F-5DC-UT	2801216	77
FLT-SEC-T1+T2-2S-350/25-FM	2905468	26	NEF 1- 6	2783082	149	PT 4X1-BE	2839363	83	PT-IQ-4X1-12DC-PT	2801269	77
FLT-SEC-T1+T2-3C-350/25-FM	2905469	25	NEF 1-10	2788977	149	PT 5-HF-5 DC-ST	2838762	90	PT-IQ-4X1-12DC-UT	2801217	77
FLT-SEC-T1+T2-3S-350/25-FM	2905470	25				PT 5-HF-12 DC-ST	2838775	90	PT-IQ-4X1-24DC-PT	2801271	77
FLT-SEC-T1-350/25-P	2905471	25				PT 5-HF-24DC-ST	2906002	90	PT-IQ-4X1-24DC-UT	2800982	77
						PT MAIN-EST	2880736	54	PT-IQ-4X1-48DC-PT	2801273	77
						PT MCR-EST	2880749	90	PT-IQ-4X1-48DC-UT	2801219	77
						PT PE/S+1X2-24-ST	2819008	86	PT-IQ-4X1-5DC-PT	2801267	77
						PT PE/S+1X2-BE	2856265	86	PT-IQ-4X1-5DC-UT	2801215	77
						PT-BE/FM	2839282	87	PT-IQ-5-HF+F-12DC-PT	2801295	79
						PT-IQ-1X2+F-12DC-PT	2801254	75	PT-IQ-5-HF+F-12DC-UT	2800801	79
						PT-IQ-1X2+F-12DC-UT	2800975	75	PT-IQ-5-HF+F-5DC-PT	2801292	79
						PT-IQ-1X2+F-24DC-PT	2801256	75	PT-IQ-5-HF+F-5DC-UT	2800798	79
						PT-IQ-1X2+F-24DC-UT	2800977	75	PT-IQ-5-HF-12DC-PT	2801293	79
						PT-IQ-1X2+F-48DC-PT	2801258	75	PT-IQ-5-HF-12DC-UT	2800799	79
						PT-IQ-1X2+F-48DC-UT	2800979	75	PT-IQ-5-HF-5DC-PT	2801291	79
						PT-IQ-1X2+F-5DC-PT	2801252	75	PT-IQ-5-HF-5DC-UT	2800797	79
						PT-IQ-1X2+F-5DC-UT	2800792	75	PT-IQ-PTB-PT	2801296	74
						PT-IQ-1X2-12DC-PT	2801253	74	PT-IQ-PTB-UT	2800768	74
						PT-IQ-1X2-12DC-UT	2800793	74	PV-SET 1000DC-SC/AC-3P-QPD	2801604	61
						PT-IQ-1X2-24DC-PT	2801255	74	PV-SET 15T/1000DC/1MPP-SPD-SC	2801529	60
						PT-IQ-1X2-24DC-UT	2800976	74	PV-SET 25T/1000DC-SPD-SD-SC	2801318	61
						PT-IQ-1X2-48DC-PT	2801257	74	PV-SET 25T/1000DC/2MPP-SPD-SC	2801317	60
						PT-IQ-1X2-48DC-UT	2800978	74	PV-SET 35T-SPD-FESD-SC	2901860	59
						PT-IQ-1X2-5DC-PT	2801251	74	PV-SET 35T/1000DC/3MPP-SPD-SC	2801531	61
						PT-IQ-1X2-5DC-UT	2800791	74	PV-SET 45T/1000DC/SPD-SC	2801297	59
						PT-IQ-1X2-EX-24DC-P	2801514	81	PWT 100-800AC-FM	2800531	35
						PT-IQ-1X2-EX-24DC-UT	2801512	81	PWT 35-800AC-FM	2800419	34
						PT-IQ-1X2-TELE-P	2800782	80	PWT CCT-SET	2800532	35
						PT-IQ-1X2-TELE-PT	2801290	80	PWT CCT-SET 4	2905613	35
						PT-IQ-1X2-TELE-UT	2800769	80			
						PT-IQ-2X1+F-12DC-PT	2801246	75			
						PT-IQ-2X1+F-12DC-UT	2800781	75			
						PT-IQ-2X1+F-24DC-PT	2801248	75			
						PT-IQ-2X1+F-24DC-UT	2800788	75			
						PT-IQ-2X1+F-48DC-PT	2801250	75	QUINT-BAT/24DC/ 3.4AH	2866349	241
						PT-IQ-2X1+F-48DC-UT	2800790	75	QUINT-BAT/24DC/ 7.2AH	2866352	241
						PT-IQ-2X1+F-5DC-PT	2801244	75	QUINT-BAT/24DC/12AH	2866365	241
						PT-IQ-2X1+F-5DC-UT	2800779	75	QUINT-BUFFER/24DC/24DC/40	2320393	235
						PT-IQ-2X1-12DC-PT	2801245	75	QUINT-DIODE/12-24DC/2X20/1X40	2320157	212
						PT-IQ-2X1-12DC-UT	2800780	75	QUINT-DIODE/48DC/2X20/1X40	2320160	213
						PT-IQ-2X1-24DC-PT	2801247	75	QUINT-ORING/24DC/2X10/1X20	2320173	208
						PT-IQ-2X1-24DC-UT	2800787	75	QUINT-ORING/24DC/2X20/1X40	2320186	209
						PT-IQ-2X1-48DC-PT	2801249	75	QUINT-ORING/24DC/2X40/1X80	2902879	209
						PT-IQ-2X1-48DC-UT	2800789	75	QUINT-PS-ADAPTERS7/1	2938196	214
						PT-IQ-2X1-5DC-PT	2801243	75	QUINT-PS-ADAPTERS7/2	2938206	214
						PT-IQ-2X1-5DC-UT	2800778	75	QUINT-PS/ 3AC/24DC/20/CO	2320924	167
						PT-IQ-2X2+F-12DC-PT	2801262	77	QUINT-PS/12DC/12DC/8	2905007	199
						PT-IQ-2X2+F-12DC-UT	2800985	77	QUINT-PS/12DC/24DC/ 5	2320131	198
						PT-IQ-2X2+F-24DC-PT	2801264	77	QUINT-PS/1AC/12DC/15	2866718	162
						PT-IQ-2X2+F-24DC-UT	2800981	77	QUINT-PS/1AC/12DC/20	2866721	162

# Index

## Alphabetical

Type	Order No.	Page	Type	Order No.	Page	Type	Order No.	Page	Type	Order No.	Page
QUINT-PS/1AC/24DC/3.5	2866747	158	STEP-DIODE/5-24DC/2X5/1X10	2868806	213	TT-EX(I)-M-24DC	2803865	95	VAL-MS 1000DC-PV-ST	2800624	58
QUINT-PS/1AC/24DC/5	2866750	158	STEP-PS/1AC/5DC/2	2320513	190	TT-ST-2-PE-24DC	2858878	96	VAL-MS 1000DC-PV/2+V	2800628	58
QUINT-PS/1AC/24DC/5/CO	2320908	166	STEP-PS/1AC/5DC/6.5	2868541	191	TT-ST-2-PE/S2-24DC	2801458	97	VAL-MS 1000DC-PV/2+V-FM	2800627	58
QUINT-PS/1AC/24DC/10	2866763	159	STEP-PS/1AC/12DC/1	2868538	192	TT-ST-2/2-24DC	2858881	96	VAL-MS 120 ST	2807586	45
QUINT-PS/1AC/24DC/10/CO	2320911	167	STEP-PS/1AC/12DC/1.5	2868567	193	TT-ST-2/2-S-12DC	2921310	97	VAL-MS 230	2839127	44
QUINT-PS/1AC/24DC/20	2866776	159	STEP-PS/1AC/12DC/1.5/FL	2868554	192	TT-ST-2/2-S-24DC	2920735	97	VAL-MS 230 IT ST	2807599	45
QUINT-PS/1AC/24DC/20/CO	2320988	167	STEP-PS/1AC/12DC/3	2868570	193	TT-ST-M-2-PE-24AC	2858920	96	VAL-MS 230 ST	2798844	40
QUINT-PS/1AC/24DC/40	2866789	159	STEP-PS/1AC/12DC/5	2868583	193	TT-ST-M-2-PE-24DC	2858904	96	VAL-MS 230/1+1	2804429	41
QUINT-PS/1AC/48DC/5	2866679	163	STEP-PS/1AC/15DC/4	2868619	191	TT-ST-M-2/2-24AC	2858933	96	VAL-MS 230/1+1-FM	2804432	41
QUINT-PS/1AC/48DC/10	2866682	163	STEP-PS/1AC/24DC/0.5	2868596	186	TT-ST-M-2/2-24DC	2858917	96	VAL-MS 320/1+0	2800103	41
QUINT-PS/1AC/48DC/20	2866695	163	STEP-PS/1AC/24DC/0.75	2868635	187	TT-ST-M-EX(I)-24DC	2859424	97	VAL-MS 230/2+0-FM	2800102	41
QUINT-PS/24DC/12DC/8	2320115	197	STEP-PS/1AC/24DC/0.75/FL	2868622	187	TT-ST-M-SFP-24AC	2858946	148	VAL-MS 230/3+1	2838209	40
QUINT-PS/24DC/24DC/5	2320034	196	STEP-PS/1AC/24DC/1.75	2868648	188				VAL-MS 230/3+1 FM	2838199	40
QUINT-PS/24DC/24DC/5/CO	2320542	202	STEP-PS/1AC/24DC/2.5	2868651	188				VAL-MS 230/FM	2839130	44
QUINT-PS/24DC/24DC/10	2320092	196	STEP-PS/1AC/24DC/3.8/C2LPS	2868677	189				VAL-MS 3+V-BE	2905859	59
QUINT-PS/24DC/24DC/10/CO	2320555	202	STEP-PS/1AC/24DC/4.2	2868664	189				VAL-MS 320 ST	2838843	40
QUINT-PS/24DC/24DC/20	2320102	197	STEP-PS/1AC/48DC/2	2868680	191	UC-TM 6 GN	0818360	135	VAL-MS 320-UD ST	2858315	40
QUINT-PS/24DC/24DC/20/CO	2320568	203	STEP-PS/277AC/24DC/3.5	2904945	189	UK 6-FSI/C	3118203	262	VAL-MS 320/1+0	2800480	41
QUINT-PS/24DC/48DC/5	2320128	197	STEP-PS/48AC/24DC/0.5	2868716	187	UK 6-FSI/C-LED12	3001925	262	VAL-MS 320/1+1-FM	2804393	41
QUINT-PS/2AC/1DC/24DC/20	2320830	165	STEP-UPS/12DC/12DC/4	2868693	236	UK 6-FSI/C-LED24	3001938	262	VAL-MS 320/3+0	2920230	41
QUINT-PS/3AC/24DC/5	2866734	160	STEP-UPS/24DC/24DC/3	2868703	236	UNO-DIODE/5-24DC/2X10/1X20	2905489	213	VAL-MS 320/3+0-FM	2920243	41
QUINT-PS/3AC/24DC/10	2866705	161	SVP 2E-48AC	2788919	118	UNO-PS/1AC/5DC/25W	2904374	178	VAL-MS 320/3+1	2859178	40
QUINT-PS/3AC/24DC/20	2866792	161	SVP 2E-110AC	2765534	118	UNO-PS/1AC/5DC/40W	2904375	178	VAL-MS 320/3+1-FM	2859181	40
QUINT-PS/3AC/24DC/40	2866802	161	SVP 3E-110AC	2765521	118	UNO-PS/1AC/12DC/30W	2902998	177	VAL-MS 320/3+1-FM-UD	2856689	40
QUINT-PS/3AC/48DC/20	2320827	164	SZS 0,6X3,5	1205053	268	UNO-PS/1AC/12DC/55W	2902999	177	VAL-MS 350 VF ST	2856595	42
QUINT-PS/48DC/24DC/5	2320144	200				UNO-PS/1AC/12DC/100W	2902997	177	VAL-MS 350 VF/1+1	2901865	43
QUINT-PS/48DC/48DC/5	2905008	201				UNO-PS/1AC/15DC/55W	2903001	179	VAL-MS 350 VF/1+1-FM	2902577	43
QUINT-PS/60-72DC/24DC/10	2905009	201				UNO-PS/1AC/15DC/100W	2903002	179	VAL-MS 350 VF/3+0	2901861	42
QUINT-PS/60-72DC/24DC/10/CO	2905011	203	TAE-TRAB FM-NFN-AP	2749628	115	UNO-PS/1AC/15DC/30W	2903000	179	VAL-MS 350 VF/3+0-FM	2901862	42
QUINT-PS/96-110DC/24DC/10	2905010	201	TCP 0,25A	0712123	263	UNO-PS/1AC/24DC/30W	2902991	174	VAL-MS 350 VF/3+1	2858755	42
QUINT-PS/96-110DC/24DC/10/CO	2905012	203	TCP 0,5A	0712152	263	UNO-PS/1AC/24DC/60W	2902992	174	VAL-MS 350 VF/FM	2856579	43
QUINT-PS/FAN/4	2320076	214	TCP 1A	0712194	263	UNO-PS/1AC/24DC/100W	2902993	175	VAL-MS 350VF	2856582	43
QUINT-UPS/1AC/1AC/500VA	2320270	223	TCP 2A	0712127	263	UNO-PS/1AC/24DC/150W	2904376	175	VAL-MS 350VF/3+1-FM	2858632	42
QUINT-UPS/24DC/24DC/5	2320212	224	TCP 3A	0712233	263	UNO-PS/1AC/24DC/240W	2904372	175	VAL-MS 385/65 ST	2920308	49
QUINT-UPS/24DC/24DC/5/1.3AH	2320254	234	TCP 4A	0712259	263	UNO-PS/1AC/24DC/90W/C2LPS	2902994	176	VAL-MS 385/65/3+0	2921019	49
QUINT-UPS/24DC/24DC/10	2320225	221	TCP 5/DC32V	0700005	262	UNO-PS/1AC/24DC/60W	2902995	180	VAL-MS 385/65/3+0-FM	2921006	49
QUINT-UPS/24DC/24DC/10/3.4AH	2320267	234	TCP 6A	0712275	263	UNO-PS/1AC/48DC/100W	2902996	180	VAL-MS 385/65/3+1	2920890	49
QUINT-UPS/24DC/24DC/20	2320238	221	TCP 7,5/DC32V	0700007	262	UNO-PS/2AC/24DC/90W/C2LPS	2904371	176	VAL-MS 385/65/3+1-FM	2920887	49
QUINT-UPS/24DC/24DC/40	2320241	221	TCP 8A	0712291	263	UNO-UPS/24DC/24DC/60W	2905907	237	VAL-MS 385/80 ST	2920353	49
QUINT-UPS/24DC/12DC/5/24DC/10	2320461	222	TCP 10/DC32V	0700010	262	UPS-BAT/LHON/24DC/120WH	2320351	225	VAL-MS 385/80/3+0	2921093	49
			TCP 10A	0712314	263	UPS-BAT/VRLA-WTR/24DC/13AH	2320416	228	VAL-MS 385/80/3+0-FM	2921080	49
			TCP 15/DC32V	0700015	262	UPS-BAT/VRLA-WTR/24DC/26AH	2320429	228	VAL-MS 385/80/3+1	2920971	49
			TCP 20/DC32V	0700020	262	UPS-BAT/VRLA/24DC/1.3AH	2320296	226	VAL-MS 385/80/3+1-FM	2920968	49
			TCP 25/DC32V	0700025	262	UPS-BAT/VRLA/24DC/3.4AH	2320306	226	VAL-MS 400 ST	2816399	45
			TCP 30/DC32V	0700030	262	UPS-BAT/VRLA/24DC/7.2AH	2320319	227	VAL-MS 500 ST	2807609	45
			TCP 40/DC32V	0700040	262	UPS-BAT/VRLA/24DC/12AH	2320322	227	VAL-MS 580-ST	2920434	41
			TG 40	2788896	134	UPS-BAT/VRLA/24DC/38AH	2320335	227	VAL-MS 580/3+0	2920450	41
			TMC 1 F1 100, 0,2A	0914015	265	UPS-CAP/24DC/10A/10KJ	2320377	224	VAL-MS 580/3+0-FM	2920447	41
			TMCP 1 F1 300, 0,2A	0915506	265	UPS-CAP/24DC/20A/20KJ	2320380	224	VAL-MS 60	2868020	44
			TMCP CONNECT LR	0916592	265	UPS-CONF	2320403	230	VAL-MS 60/FM	2868033	44
			TMCP SB	0916602	265	UT 6-TMC M 0,5A	0916603	264	VAL-MS 600DC-PV-ST	2800623	58
			TMCP SOCKET M	0916589	265	UT 6-TMC M 10A	0916610	264	VAL-MS 600DC-PV/2+V	2800642	58
			TRIO-DIODE/12-24DC/2X10/1X20	2866514	210	UT 6-TMC M 12A	0916611	264	VAL-MS 600DC-PV/2+V-FM	2800641	58
S-PT-1X2-24DC	2880668	98	TRIO-DIODE/48DC/2X10/1X20	2866527	211	UT 6-TMC M 15A	0916612	264	VAL-MS 75 VF ST	2805318	47
S-PT-1X2-24DC-1/2"	2882569	98	TRIO-PS-2G/1AC/24DC/10	2903149	169	UT 6-TMC M 16A	0916613	264	VAL-MS 750/30-ST	2920256	48
S-PT-1X2-24DC-3/4"	2882598	98	TRIO-PS-2G/1AC/24DC/20	2903151	169	UT 6-TMC M 1A	0916604	264	VAL-MS 750/30/3+0	2920269	48
S-PT-2XEX-24DC	2800040	99	TRIO-PS-2G/1AC/24DC/3/C2LPS	2903147	168	UT 6-TMC M 2A	0916605	264	VAL-MS 750/30/3+0-FM	2920272	48
S-PT-2XEX-48DC	2800038	99	TRIO-PS-2G/1AC/24DC/5	2903148	169	UT 6-TMC M 4A	0916606	264	VAL-MS 800/30 VF/FM	2805402	48
S-PT-2XEX-48DC-1/2"	2800039	99	TRIO-PS-2G/3AC/24DC/10	2903154	171	UT 6-TMC M 5A	0916607	264	VAL-MS BE	2817741	46
S-PT-4-EX-24DC	2800036	99	TRIO-PS-2G/3AC/24DC/20	2903155	171	UT 6-TMC M 6A	0916608	264	VAL-MS BE-AR	2801065	47
S-PT-4-EX-24DC-1/2"	2800037	99	TRIO-PS-2G/3AC/24DC/5	2903153	170	UT 6-TMC M 8A	0916609	264	VAL-MS BE-AR/FM	2801066	47
S-PT-EX(I)-24DC	2880671	98	TRIO-PS/1AC/12DC/5	2866475	172	UWA 130	2901664	215	VAL-MS BE/FM	2817738	46
S-PT-EX(I)-24DC-1/2"	2882572	98	TRIO-PS/1AC/12DC/10	2866488	173	UWA 182/52	2938235	215	VAL-MS-AR 350 VF	2801489	47
S-PT-EX(I)-24DC-3/4"	2882585	98	TRIO-PS/1AC/48DC/5	2866491	173				VAL-MS-AR 350 VF/FM	2801490	47
S-PT-EX-24DC	2800034	99	TRIO-PS/1AC/48DC/10	2866501	173				VAL-MS-AR 75 VF	2801487	47
S-PT-EX-24DC-1/2"	2800035	99	TRIO-PS/3AC/24DC/40	2866404	171				VAL-MS-AR 75 VF/FM	2801488	47
S-PT-EX-48DC	2800053	99	TRIO-PS/600DC/24DC/20	2866530	172				VAL-MS-AR-T1/T2 75	2801491	47
S-PT-EX-48DC-1/2"	2800054	99	TRIO-UPS/1AC/24DC/5	2866611	238				VAL-MS-AR-T1/T2 75/FM	2801492	47
SFP 1-10/120AC	2920670	147	TT-2-PE-24DC	2838186	94	VAL-CP-350-ST	2859602	61	VAL-MS-T1/T2 1000DC-PV-ST	2801162	58
SFP 1-15/120AC	2920683	147	TT-2-PE-110AC	2858483	94	VAL-CP-350-ST-GY	2882718	51	VAL-MS-T1/T2 1000DC-PV/2+V	2801160	58
SFP 1-20/120AC	2856702	146	TT-2-PE-M-24DC	2920641	94	VAL-CP-MCB-1S-350/40/FM	2882763	53	VAL-MS-T1/T2 1000DC-PV/2+V-FM	2801161	58
SFP 1-20/230AC	2859987	146	TT-2-PE/S1-24DC	2839538	95	VAL-CP-MCB-3C-350/40/FM	2882776	53	VAL-MS-T1/T2 1000DCPV-UD-ST	2801231	59
SFP 1-5/120AC	2920667	147	TT-2-PE/S1-M-24DC	2920638	95	VAL-CP-MCB-3S-350/40/FM	2882750	53	VAL-MS-T1/T2 175/12.5 ST	2800676	36
SPRING-LOCK	0713009	265	TT-2/2-24DC	2838173	95	VAL-CP-MOSO 60-3C-FM	2804416	52	VAL-MS-T1/T2 175/12.5/1+0	2801043	37
SSA 3-6	2839295	135	TT-2/2-M-24DC	2920722	95	VAL-CP-MOSO 60-3S-FM	2804403	52	VAL-MS-T1/T2 175/12.5/1+0-FM	2801044	37
SSA 5-10	2839512	135	TT-D-2-PE-M-BK	2920654	94	VAL-CP-N/PE-350-ST	2859699	61	VAL-MS-T1/T2 175/12.5/1+1	2800675	37
ST 4-FSI/C	3036372	262	TT-D-2-PE-M-BU	2803878	95	VAL-CP-N/PE-350-ST-GY	2882734				

Type	Order No.	Page	Type	Order No.	Page
VAL-MS-T1/T2 175/12.5/3+1-FM	2800670	36			
VAL-MS-T1/T2 335/12.5 ST	2800190	36			
VAL-MS-T1/T2 335/12.5/1+0	2801041	37			
VAL-MS-T1/T2 335/12.5/1+0-FM	2801042	37			
VAL-MS-T1/T2 335/12.5/1+1	2800187	37			
VAL-MS-T1/T2 335/12.5/1+1-FM	2800186	37			
VAL-MS-T1/T2 335/12.5/3+0	2800189	37			
VAL-MS-T1/T2 335/12.5/3+0-FM	2800188	37			
VAL-MS-T1/T2 335/12.5/3+1	2800184	36			
VAL-MS-T1/T2 335/12.5/3+1-FM	2800183	36			
VAL-MS-T1/T2 335/12.5/4+0	2800645	36			
VAL-MS-T1/T2 335/12.5/4+0-FM	2800644	36			
VAL-MS-T1/T2 48/12.5 ST	2801242	38			
VAL-MS-T1/T2 48/12.5/1+0	2801241	38			
VAL-MS-T1/T2 48/12.5/1+0-FM	2801240	38			
VAL-MS-T1/T2 48/12.5/1+1V	2801532	38			
VAL-MS-T1/T2 48/12.5/1+1V-FM	2801533	38			
VAL-MS-T1/T2 600DC-PV-ST	2801165	58			
VAL-MS-T1/T2 600DC-PV/2+V	2801163	58			
VAL-MS-T1/T2 600DC-PV/2+V-FM	2801164	58			
VAL-MS-T1/T2 75/12.5 ST	2801146	47			
VAL-MS/2+0-BE	2804584	46			
VAL-MS/2+0-BE/FM	2805321	46			
VAL-MS/3+0-BE	2881816	45			
VAL-MS/3+0-BE/FM	2881803	45			
VAL-MS/4+0-BE/FM RN.	2906484	46			
VAL-SEC-T2-175-P	2905355	28			
VAL-SEC-T2-1S-175-FM	2905348	29			
VAL-SEC-T2-1S-350	2905341	29			
VAL-SEC-T2-1S-350-FM	2905333	29			
VAL-SEC-T2-2C-175-FM	2905350	29			
VAL-SEC-T2-2C-350	2905342	29			
VAL-SEC-T2-2C-350-FM	2905337	29			
VAL-SEC-T2-2S-175-FM	2905351	29			
VAL-SEC-T2-2S-350	2905343	29			
VAL-SEC-T2-2S-350-FM	2905338	29			
VAL-SEC-T2-350-P	2905346	25			
VAL-SEC-T2-3C-175-FM	2905353	28			
VAL-SEC-T2-3C-350	2905344	28			
VAL-SEC-T2-3C-350-FM	2905339	28			
VAL-SEC-T2-3S-175-FM	2905354	28			
VAL-SEC-T2-3S-350	2905345	28			
VAL-SEC-T2-3S-350-FM	2905340	28			
VAL-SEC-T2-N/PE-175-P	2905356	28			
VAL-SEC-T2-N/PE-350-P	2905347	28			
VAL-US 120 ST	2800739	46			
VAL-US 240 ST	2800740	46			
VAL-US 277 ST	2800741	46			
VAL-US 347 ST	2800742	46			
VAL-US 480 ST	2800743	46			
VAL-US 60 ST	2800738	46			
VIP-2/SC/PDM-2/16	2315256	214			
VIP-2/SC/PDM-2/24	2315269	214			
VIP-2/SC/PDM-2/32	2315272	214			
VIP-2/SC/PDM-2/48	2903717	214			
VIP-CAB-FLK16/FR/FR/0,14/0,5M	2900154	92			
VIP-CAB-FLK16/FR/FR/0,14/1,0M	2900155	92			
VIP-CAB-FLK16/FR/FR/0,14/2,0M	2900156	92			

## Z

ZB 12:UNPRINTED	0812120	135
ZBN 18 CUS	0825059	135





For up-to-date modifications or supplements  
to the catalog contents, please visit:  
**[phoenixcontact.net/webcode/#0132](http://phoenixcontact.net/webcode/#0132)**

