

THE FLASH PROGRAMMER MODEL TFP3

Quick Start Guide
March 2015

©2015 Maxim Integrated Products, Inc.
All rights reserved.

No part of this documentation may be reproduced nor distributed in any form or by any means, graphic, electronic, or mechanical, including but not limited to photocopying, scanning, recording, taping, e-mailing, or storing in information storage and retrieval systems without the written permission of Maxim Integrated Products, Inc. (hereafter, "Maxim"). Products that are referenced in this document such as Microsoft Windows® may be trademarks and/or registered trademarks of their respective owners. Maxim makes no claim to these trademarks. While every precaution has been taken in the preparation of this document, individually, as a series, in whole, or in part, Maxim, the publisher, and the author assume no responsibility for errors or omissions, including any damages resulting from the express or implied application of information contained in this document or from the use of products, services, or programs that may accompany it. In no event shall Maxim, publishers, authors, or editors of this guide be liable for any loss of profit or any other commercial damage caused or alleged to have been caused directly or indirectly by this document.

Rev. 2.3, March 2015

CONTENTS

1	Introduction	5
2	TFP3 Kit Contents	5
3	Setup and Operations	6
3.1	TFP3 Connection to the Host.....	7
3.2	TFP3 Software GUI Installation.....	8
3.3	TFP3 Connection to Target	8
3.3.1	TFP3 Connected to ZON Device (TFP3Q-MAXQ30 and TFP3L-MAXQ30).....	9
3.3.2	TFP3 Connected to 71M65xx Device (TFP3-8051)	10
3.4	Device Operation (TFP3Q-MAXQ30, TFP3-8051)	11
3.4.1	TFP3 Device Initialization.....	11
3.4.2	Encryption and Package File Generation (TFP3Q-MAXQ30, TFP3-8051).....	13
3.4.3	Loading the Package File (TFP3Q-MAXQ30, TFP3-8051)	15
3.4.4	Summary	15
3.5	Device Operation (TFP3L-MAXQ30)	16
3.6	Target Programming	18
3.6.1	Stand-Alone/Pushbutton Mode	18
3.6.2	Host Mode.....	19

TABLES

Table 1:	TFP3 Versions	5
Table 2:	ICE Connector to JTAG Cable (2x5)	9
Table 3:	ICE Connector to ICE Cable (7x1).....	10

FIGURES

Figure 1:	TFP3 Typical Connection Diagram.....	6
Figure 2:	TFP3 Connection to Host	7
Figure 3:	Device Manager	7
Figure 4:	COM Port Enumeration.....	8
Figure 5:	Selecting the TFP3 Model and Target Flash Size	11
Figure 6:	Connecting to the TFP3 Device Manually	11
Figure 7:	Setting TFP3 Model Type Manually	12
Figure 8:	Setting TFP3 DUT Flash Size Manually	12
Figure 9:	Setting TFP3 DUT Serial Number Count.....	12
Figure 10:	Setting TFP3 JTAG Clock Rate.....	13
Figure 11:	Generate TFP3 AES Keys	13
Figure 12:	Modify TFP3 AES Key	14
Figure 13:	Create Package File	14
Figure 14:	Loading the Package File.....	15
Figure 15:	Encryption Process.....	15

Figure 16: Selecting the TFP3 Model and DUT Flash Size	16
Figure 17: Configuring and Connecting the Serial Port.....	16
Figure 18: Setting the TFP3 Model Type.....	17
Figure 19: Setting the DUT Flash Size	17
Figure 20: Setting the TFP3 JTAG Clock.....	17
Figure 21: Loading the DUT Hex File.....	18
Figure 22: Stand-Alone/Push Button Mode.....	18
Figure 23: Program and Verify DUT Command.....	19

1 Introduction

The TFP3 (The Flash Programmer 3) is a multipurpose device from Maxim Integrated used to perform flash program and erase operations on Maxim energy metering SoCs. The available versions of the TFP3 are listed in *Table 1*.

Table 1: TFP3 Versions

ID	Function	Ordering Part Number
TFP3-8051	Flash Programmer for 8051-based Metering Devices. With Security ⁽¹⁾	80515-FPBM-TFP3
TFP3L-MAXQ30	Flash Programmer for ZON™ Family Metering Devices (MAXQ®-based). No Security	MAXQ30-FPBM-TFP3L#
TFP3Q-MAXQ30	Flash Programmer for ZON™ Family Metering Devices (MAXQ-based). With Security ⁽¹⁾	MAXQ30-FPBM-TFP3Q#

(1) With the security feature, the programming content is stored, programmed, and verified using AES 128-bit security.

2 TFP3 Kit Contents

- TFP3 Device
- FC-10 cable for CC51 or JTAG connection, 20-25cm in length
- USB A-to-B cable used to connect the TFP3 to the host (PC) or to a USB 5V DC adapter (not provided with the kit)
- CD-ROM containing:
 - TFP3 Windows installation executable (TFP3 XX-YY.exe) with Microsoft .NET 4.0 packaged for TFP3 GUI and CLI application software
 - TFP3 Host USB CDC driver
 - TFP3 User's Guide
 - TFP3 Quick Start Guide

MAXQ is a registered trademark and ZON is a trademark of Maxim Integrated Products, Inc.

3 Setup and Operations

Figure 1 shows the basic connection diagrams for the TFP3 for programming ZON (MAXQ30-based) and 71M65xx (8051-based) parts. It is possible to operate the TFP3 in both stand-alone (only target and TFP3) and PC-connected configurations. For stand-alone configurations, the TFP3 must be powered through the USB adaptor.

The ZON SOC or 71M65xx SOC is referred to as the target or DUT (device under test). The TFP3 contains the target image, i.e. the operational code for the flash memory of the target, in encrypted form (TFP3Q-MAXQ30 and TFP3-8051) or unencrypted form (TFP3L-MAXQ30).

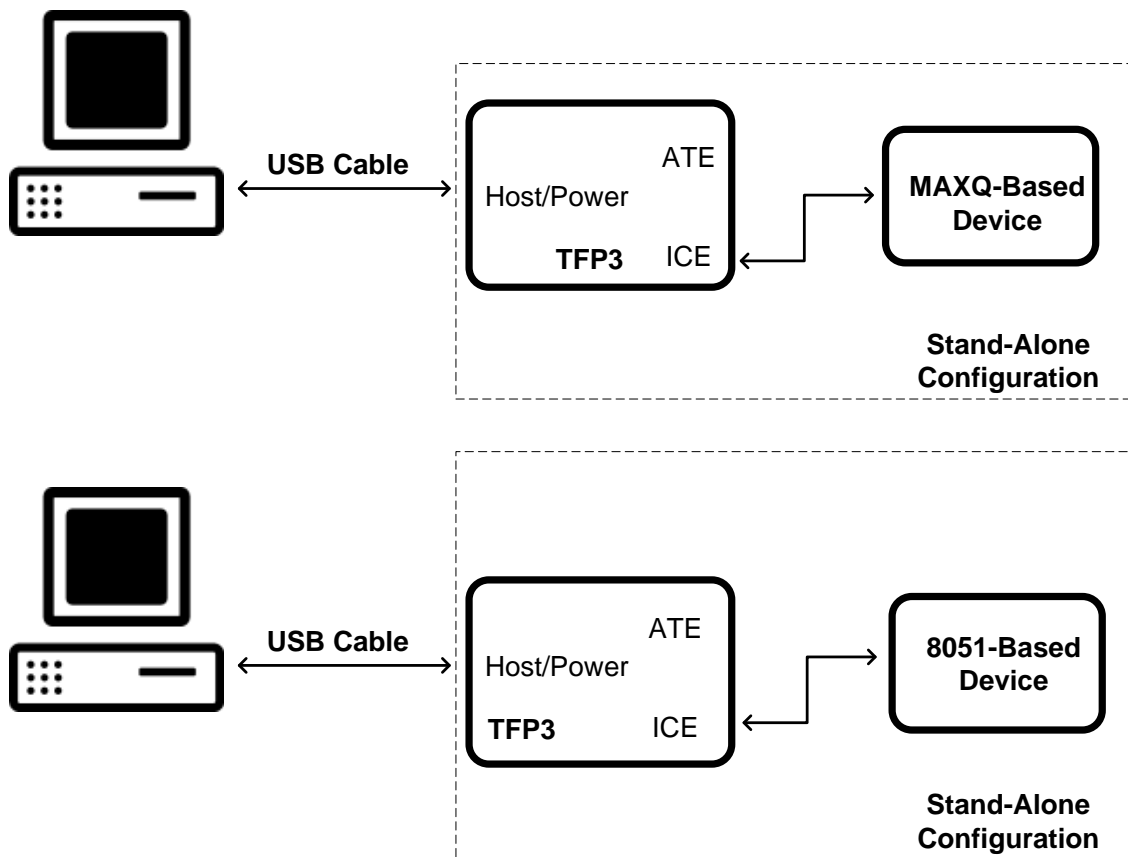

Figure 1: TFP3 Typical Connection Diagram

3.1 TFP3 Connection to the Host

Connect the USB A-B cable to the TFP3 (Host/Power Port) as shown in *Figure 2*. Plug the other end of the USB cable into an available USB port of a PC.



Figure 2: TFP3 Connection to Host

When the notification window with the text, "Installing device driver software," appears on the PC screen, go to **Start > Control Panel > Device Manager > Other Devices**. Right-click on "MAXQ CDC-ACM Demo," and then update the driver software by pointing to the "OEM54.INF" file on the CD-ROM supplied with the TFP3 Programmer's Kit.

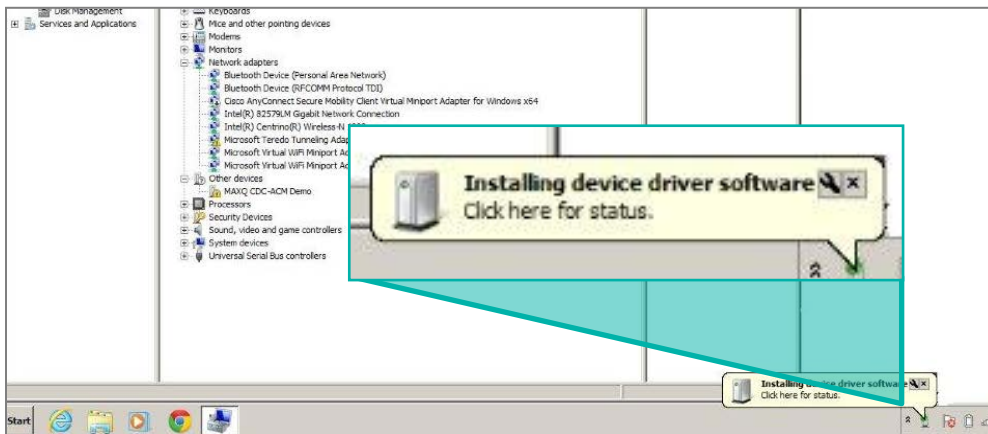

Figure 3: Device Manager

When the TFP3 Host driver software installation is successful, the TFP3 device is enumerated as a COM port, as shown in *Figure 4*.

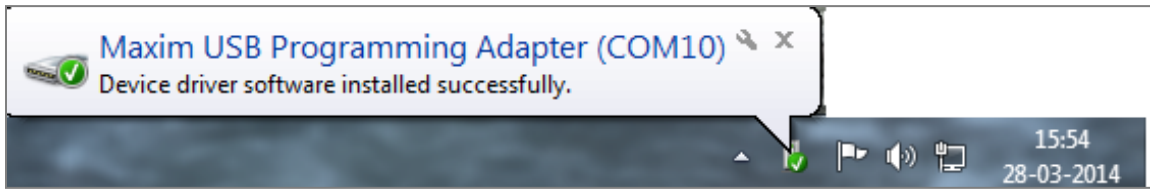

Figure 4: COM Port Enumeration

3.2 TFP3 Software GUI Installation

Insert the CD-ROM supplied with the TFP3 Kit into your PC and browse to the TFP3 Host software directory. Double-click the file named "**TFP3 - XX.YY.exe**" to start the installation process ("XX" and "YY" are major and minor versions, respectively). Follow the on-screen instructions carefully to successfully complete the TFP3 host software installation.

3.3 TFP3 Connection to Target

The 2x5 connector labeled "ICE" is intended for the target cable. *Table 2* shows the signal assignment on this connector. Pin 1 is in the top right position when looking at the connector from the outside, and pin 2 is on the bottom-right.

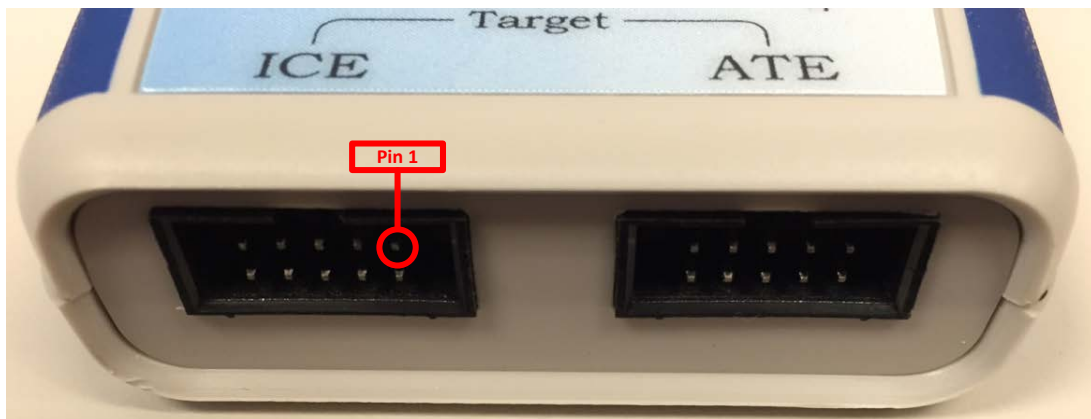

3.3.1 TFP3 Connected to ZON Device (TFP3Q-MAXQ30 and TFP3L-MAXQ30)

Plug the gray flat-ribbon cable into the 2x5 connector labeled “ICE”. Plug the other end of the cable into the JTAG programming connector on the target device. Pin 1 is marked with a triangle on the black connector body. An adapter should be used if the signal assignment on the target device is not per *Table 3* or if a different connector type is used on the target device.

Table 2: ICE Connector to JTAG Cable (2x5)

Pin Number	Signal	Function
1	ICE_E	Enables the programming interface when high
2	GND	Ground, return
3	E_RST	Emulator reset
4	VCC	Supply power (+3.3VDC at 300mA, max)
5	E_TCLK	Emulator clock
6	TMUX	Optional signal. Not required for programming
7	N/C	Not connected
8	N/C	Not connected. (+5VDC for TFP3L-MAXQ30)
9	E_RXTX	Emulator data (RX and TX), bidirectional
10	GND	Ground, return

Note: If pin 4 in *Table 2* is used to power the target, then a 1000 μ F/10V capacitor should be placed in between VCC and GND of the target board in order to prevent the TFP3 device from resetting due to the inrush current.

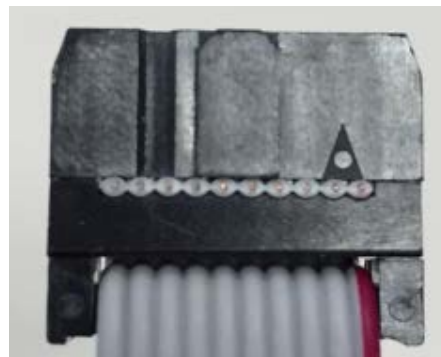

To ZON Device

3.3.2 TFP3 Connected to 71M65xx Device (TFP3-8051)

Plug the multi-colored flat-ribbon cable into the 2x5 connector labeled “ICE”. Plug the other end of the cable (7x1 connector) into the programming connector on the target device. Pin 1 is marked with a triangle on the black connector body. An adapter should be used if the signal assignment on the target device is not per *Table 3* or if a different connector type is used on the target device.

Table 3: ICE Connector to ICE Cable (7x1)

Pin Number	Signal	Function
1	TMUX	Optional signal
2	ICE_E	Enables the programming interface when high
3	GND – RETURN	Ground, return
4	E_RST	Emulator reset
5	E_TCLK	Emulator clock
6	E_RXTX	Emulator data (RX and TX), bidirectional
7	VCC	Supply power (+3.3VDC)

Note: Even though the TFP3 can supply power to the target, many target boards (e.g. 71M653x, 71M652x) assign V3P3D to the pin corresponding to pin 7 in *Table 3*. This means that the target boards still need to be powered with a separate DC supply. If pin 7 is used to power the target, then a 1000 μ F/10V capacitor should be placed in between VCC and GND of the target board in order to prevent the TFP3 device from resetting due to the inrush current.



To 8051 Device

3.4 Device Operation (TFP3Q-MAXQ30, TFP3-8051)

3.4.1 TFP3 Device Initialization

This section covers the initialization of the TFP3-8051 and TFP3Q-MAXQ30. The settings of the TFP3 are automatically stored, so no further operation is necessary after initialization.

The following steps are necessary to initialize and load the target code onto the TFP3.

1. Open the TFP3 GUI on the PC by clicking on **Start > All Programs > Maxim Integrated > TFP3 > TFP3GUI.exe**.
2. Select the Model type and DUT (target) flash size from the drop-down menus.

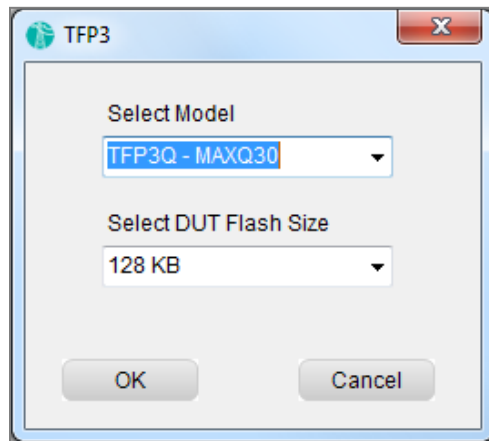

Figure 5: Selecting the TFP3 Model and Target Flash Size

3. Normally, the TFP3 GUI auto-detects and connects to the TFP3 device. To manually connect to the TFP3, it is necessary to perform the following steps:
 - a. On the **Options** menu, select **Configure Serial Port**.
 - b. On the **Device** menu, select **Connect To TFP3 Device**.

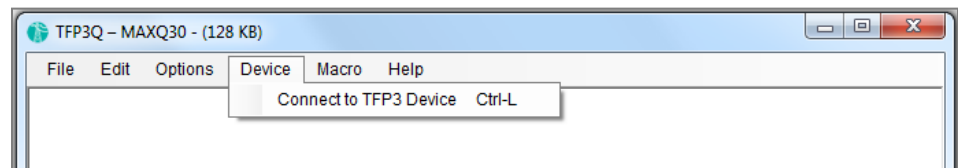

Figure 6: Connecting to the TFP3 Device Manually

- c. On the **File** menu, select **TFP3 Configuration Commands > Set TFP3 Model Type**.

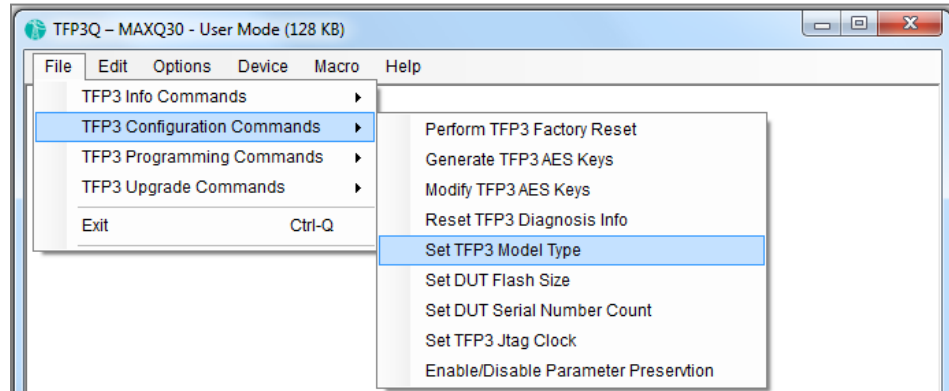

Figure 7: Setting TFP3 Model Type Manually

- d. On the **File** menu, select **TFP3 Configuration Commands > Set DUT Flash Size**.

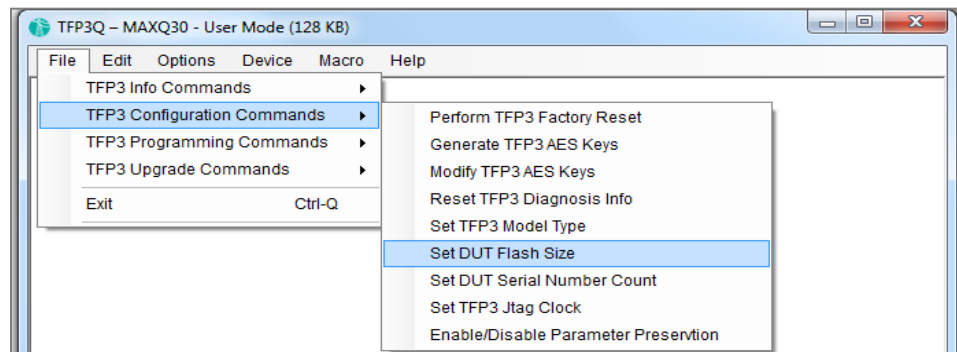

Figure 8: Setting TFP3 DUT Flash Size Manually

4. (Optional) Select DUT Serial Number Count

This step sets the unique serial number of the DUT connected to TFP3. This command is required to be sent to the TFP3 device only if the parameter preservation feature is required by the user.

On the **File** menu, select **TFP3 Configuration Commands > Set DUT Serial Number Count**

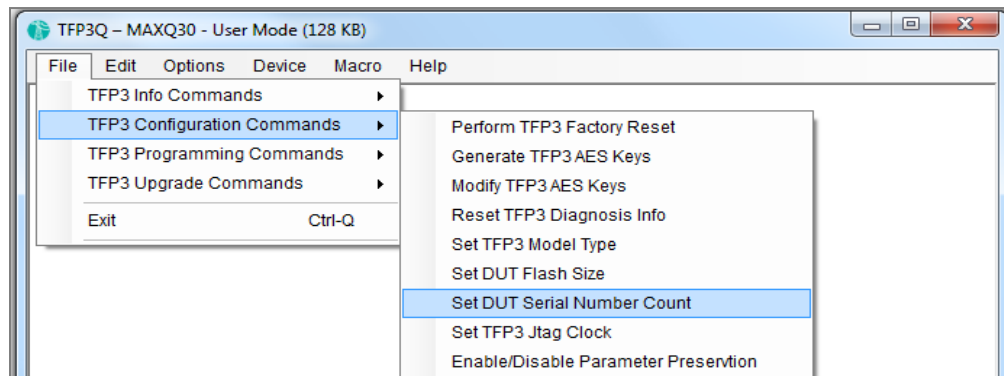

Figure 9: Setting TFP3 DUT Serial Number Count

5. (TFP3Q-MAXQ30 Model only) Select JTAG Clock Rate

Set the JTAG clock by selecting **File > TFP3 Configuration Commands > Set TFP3 JTAG Clock**.

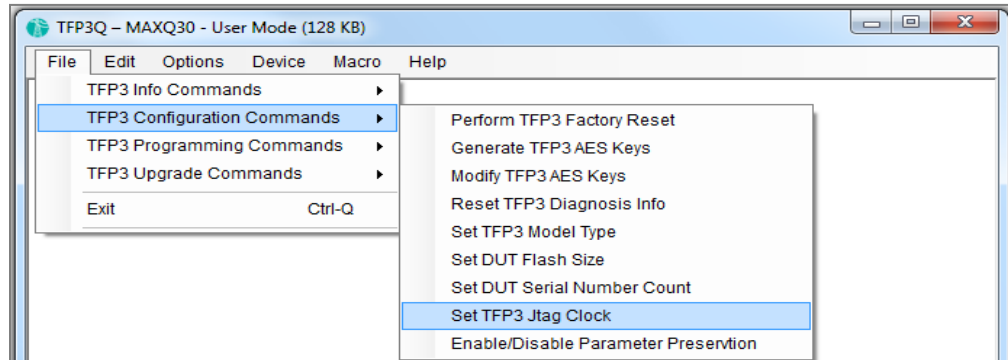

Figure 10: Setting TFP3 JTAG Clock Rate

3.4.2 Encryption and Package File Generation (TFP3Q-MAXQ30, TFP3-8051)

The encryption of the program/target file ensures that its content is secured and not accessible to anyone without the key. AES encryption is used with a key size of 128 bits. Since AES implements a symmetrical encryption method, the same key is used for both encryption and decryption.

Note that the content encryption is only needed for the TFP3Q-MAXQ30 and TFP3-8051, which feature the security function. Once a programming package is loaded on the TFP3, the content is locked. A new programming package file can be uploaded only if it contains an AES key matching the one previously loaded or if the TFP3 has been initialized by a factory reset.

3.4.2.1 AES Key Generation

The AES key generation is needed in case the previous AES key is not trusted.

Once the TFP3 is successfully connected to the Loader, select **File > TFP3 Configuration Commands > Generate TFP3 AES Keys**.

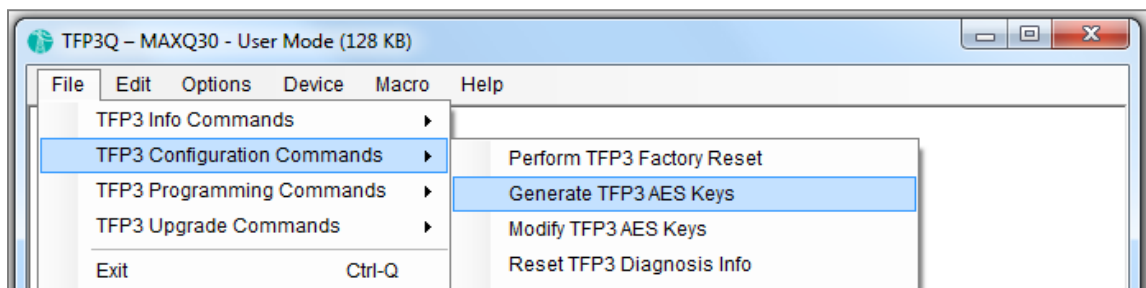

Figure 11: Generate TFP3 AES Keys

Specify the name of the new AES key file.

3.4.2.2 AES Key Modification

This step is needed to allow the newly generated programming package to be loaded in a TFP3 device. In order to do so, the AES key used in the previously loaded programming package (the “old” key) must be entered. The steps necessary to do this are indicated below. Alternatively, a new programming package (with a new AES key), can be loaded after performing a factory reset on the TFP3.

After a factory reset, the default key is 0xFFFF.FFFF.FFFF.FFFF.FFFF.FFFF.FFFF.FFFF.

On the **File** menu, select **TFP3 Configuration Commands > Modify TFP3 AES Keys**.

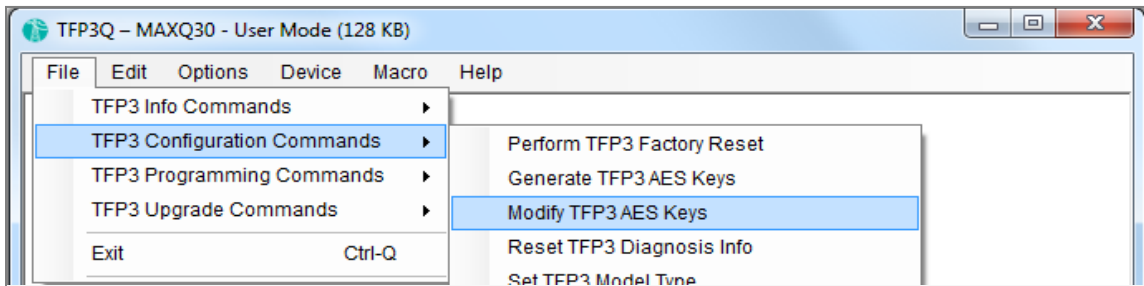

Figure 12: Modify TFP3 AES Key

Note: Follow the instructions on GUI console for completion of the command.

The old AES key file would contain the key used for the package file already loaded in the TFP3. This will allow performing operations on a previously loaded TFP3 device.

A default key is available with the GUI installation package: AES_Keys_old.pas

3.4.2.3 Create Package File

The package file is a text file containing the encrypted target image. Create the package file by selecting **File > TFP3 Programming commands > Generate TFP3 Package file**.

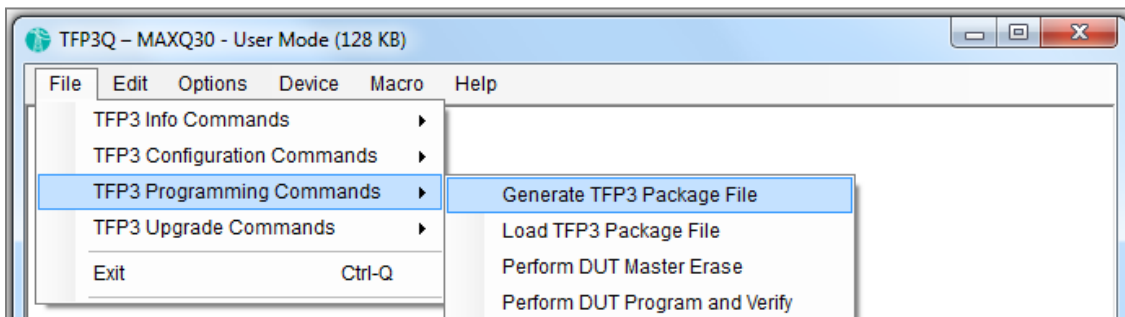

Figure 13: Create Package File

Note: Follow the instructions on the GUI console for completion of the command.

3.4.3 Loading the Package File (TFP3Q-MAXQ30, TFP3-8051)

Load the newly generated package file onto the TFP3 device by selecting **File > TFP3 Programming Commands > Load TFP3 Package File**.

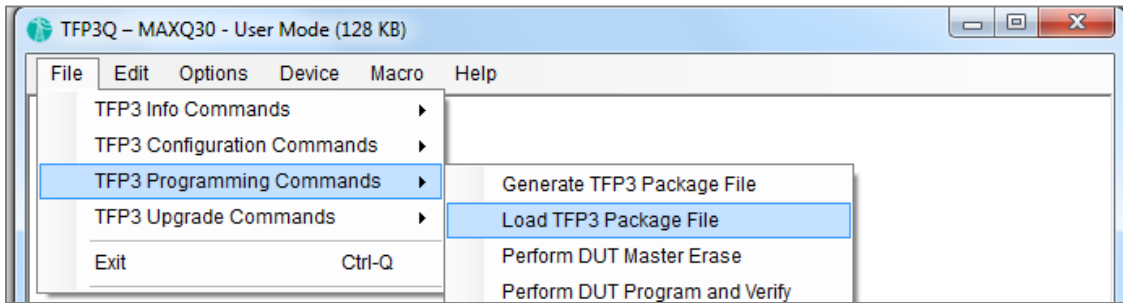

Figure 14: Loading the Package File

3.4.4 Summary

Figure 15 summarizes the encryption process.

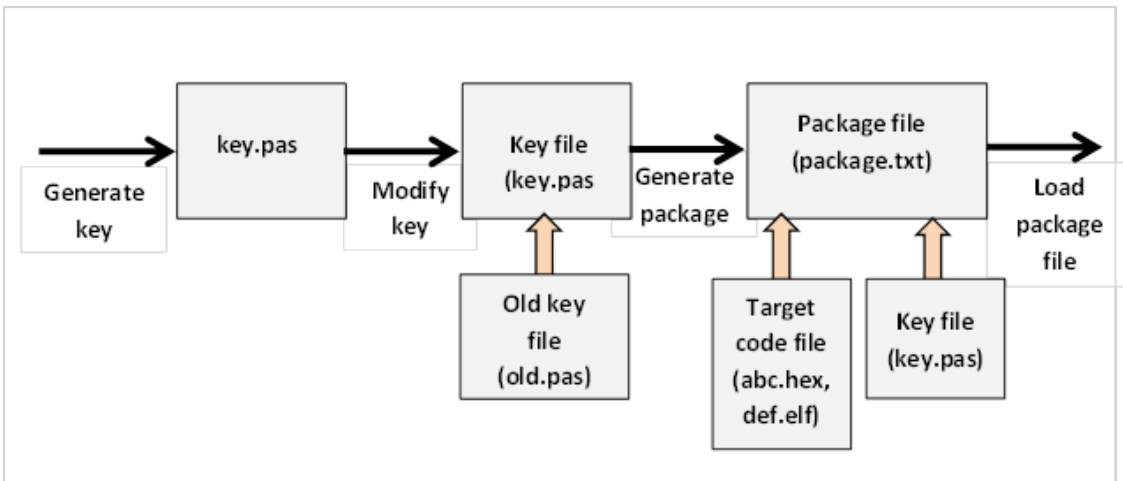

Figure 15: Encryption Process

3.5 Device Operation (TFP3L-MAXQ30)

The following steps are necessary to initialize and load DUT code into the TFP3L device. The settings of the TFP3 programmers are automatically stored, so no further operation is necessary.

1. Open "TFP3GUI.exe" in your PC from **Start > All Programs > Maxim Integrated > TFP3 > TFP3GUI.exe**.
2. Select TFP3 Model and DUT Flash Size
 - a. Select Model type and DUT flash size from the drop-down menus.

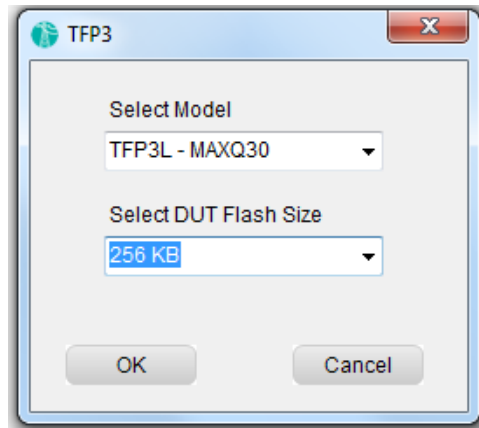

Figure 16: Selecting the TFP3 Model and DUT Flash Size

3. Configure and Connect the Serial Port

Normally, the TFP3 GUI auto-detects and connects to the TFP3 device. To manually connect to the TFP3, it is necessary to perform the following steps:

 - a. On the **Options** menu, select **Configure Serial Port**. (optional)
 - b. On the **Device** menu, select **Connect To TFP3 Device**. (optional)

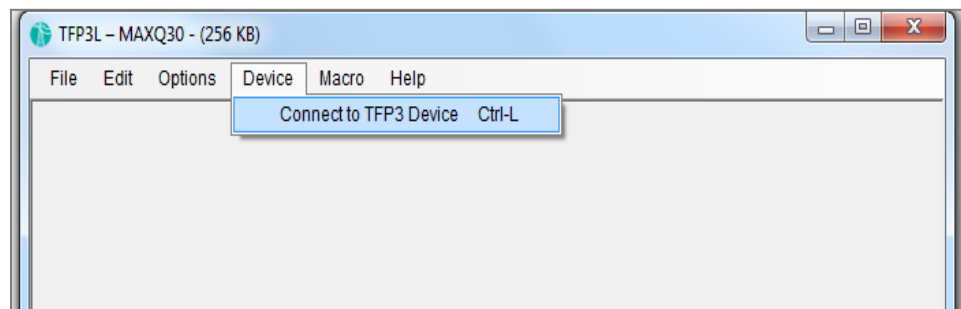

Figure 17: Configuring and Connecting the Serial Port

4. Set TFP3 Model Type

On the **File** menu, select **TFP3 Configuration Commands > Set TFP3 Model Type**.

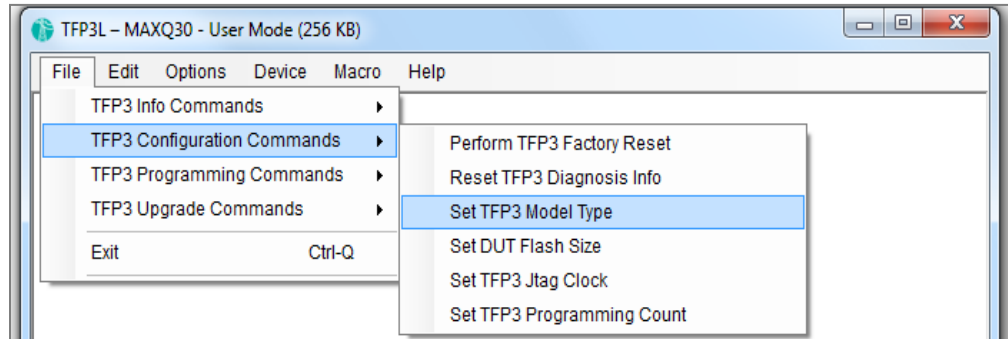

Figure 18: Setting the TFP3 Model Type

5. Set DUT Flash Size

On the **File** menu, select **TFP3 Configuration Commands > Set DUT Flash Size**.

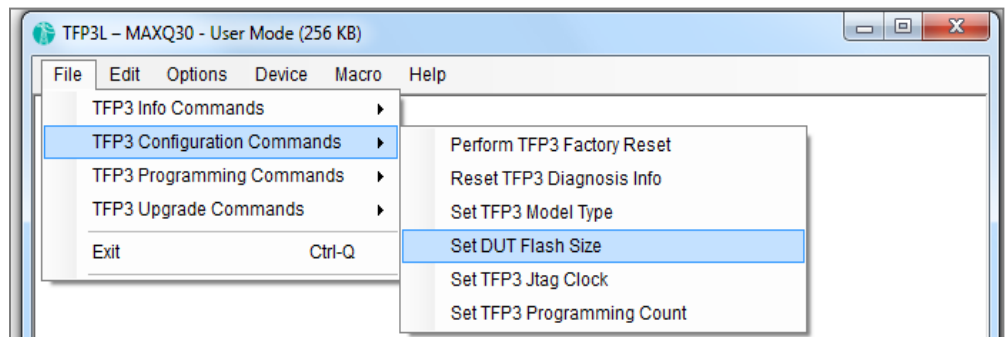

Figure 19: Setting the DUT Flash Size

6. (for TFP3L-MAXQ30 Model only) Set JTAG Clock

Set the JTAG clock by selecting **File > TFP3 Configuration Commands > Set TFP3 JTAG Clock**.

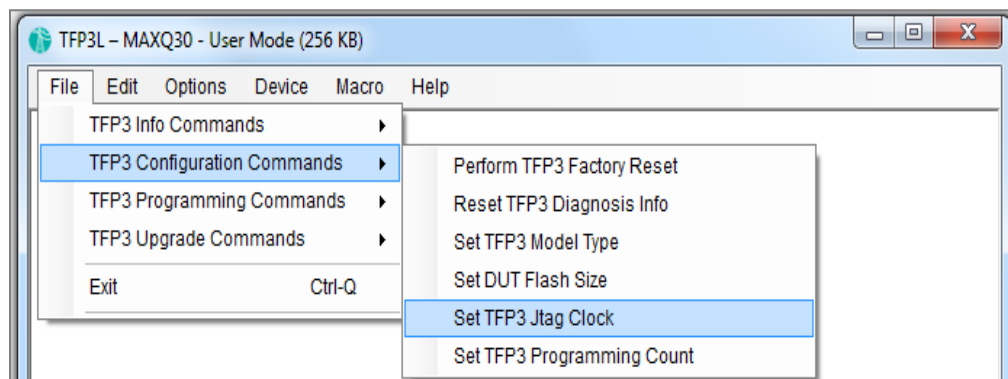

Figure 20: Setting the TFP3 JTAG Clock

7. Load DUT HexFile onto the TFP3

Note: There is no package file for this model type.

Load the DUT Hex file onto the TFP3 device by selecting **File > TFP3 Programming commands > Load DUT Hex File**.

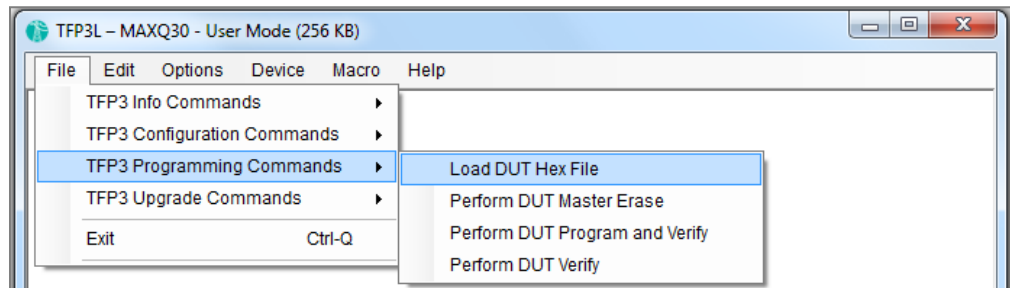

Figure 21: Loading the DUT Hex File

3.6 Target Programming

The target device can be programmed and verified by one of the following methods:

- **Stand-alone mode:** No PC is connected to the TFP3. The programming operation is started by pressing the red pushbutton.
- **Host mode:** The TFP3 is connected to both the target and to the PC. The programming operation is started using the GUI.

3.6.1 Stand-Alone/Pushbutton Mode

Connect the target DUT to the TFP3 device using the target cable. Connect the TFP3 to a 5V USB adaptor. Wait until the TFP3 status LED turns green. Then press the red pushbutton on the TFP3 device for at least 0.3 seconds, and then release it. This will initiate the program and verify operation.



Figure 22: Stand-Alone/Push Button Mode

Note: In order for the TFP3 to operate properly in Stand-Alone mode, the USB cable should be disconnected from the Host PC GUI.

3.6.2 Host Mode

Connect the target DUT to the TFP3 device using the target cable. Connect the TFP3 device to the PC with the USB cable. Wait until the TFP3 status LED turns green, and then open the TFP3 GUI. Send the program and verify DUT command by selecting **File > TFP3 Programming Commands > Perform DUT Program And Verify**.

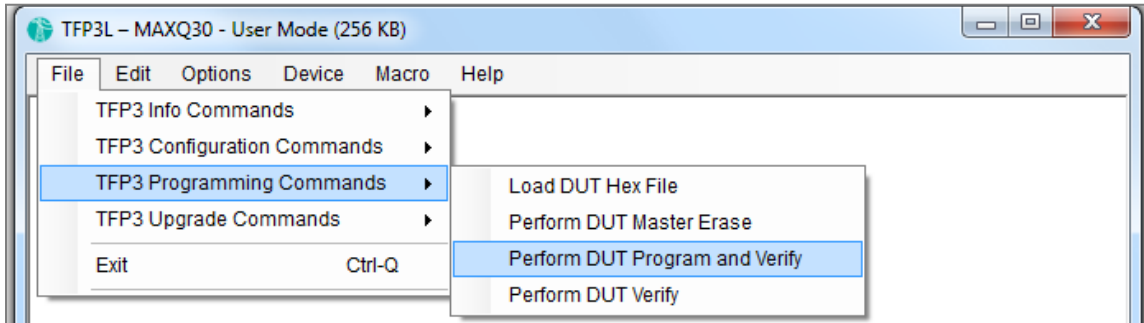

Figure 23: Program and Verify DUT Command

Note: Refer to the TFP3 GUI Help documentation for detailed information about the TFP3 GUI commands.

REVISION HISTORY

Revision, Date	Change	Page(s)
2.3, Mar. 2015	Updated the note on powering the target board under Table 2 and Table 3	9, 10
2.2, Jan. 2015	Reformatted with Customer-Facing Documents template	All
2.1, Jan. 2015	Added chapter 3.4.4 and Figure 6. Added note on powering the target board under Table 3.	9, 14
2.0, Dec. 2014	Added TFP3L version, connector, and cable description.	All
1.1, Nov. 2014	Added TFP3L version	
1.0, June 2014	Initial release	