

# AMP Dynamic Series Connectors

RoHS  
Ready 

## Overview

### Disclaimer

While Tyco Electronics Corporation and its affiliates referenced herein ("Tyco Electronics") have made every reasonable effort to ensure the accuracy of the information in this catalog, Tyco Electronics does not guarantee that it is error-free, nor does Tyco Electronics make any other representation, warranty or guarantee that the information is accurate, correct, reliable or current. Tyco Electronics reserves the right to make any adjustments to the information contained herein at any time without notice. Tyco Electronics expressly disclaims all implied warranties regarding the information contained herein, including, but not limited to, any implied warranties of merchantability or fitness for a particular purpose. Tyco Electronics' only obligations are those in the Tyco Electronics Standard Terms and Conditions of Sale, and in no case will Tyco Electronics be responsible for any incidental, indirect, or consequential damages arising from the sale, resale, use, or misuse of its products. Users should independently evaluate the suitability of, and test each product for, their application.

The dimensions, specifications, designs, construction, materials and processes in this catalog are for reference purposes only and are subject to change without notice. Please consult Tyco Electronics for the most current product information.

The export of certain Tyco Electronics products is restricted by the Arms Export Control Act (Title 22, U.S.C. Sec 2751, et seq.) or the Export Administration Act of 1979, as amended (Title 50, U.S.C., App. 2401 et seq.). Orders may be subject to export approval by the U.S. Government. Buyer must comply with all applicable export laws of all applicable jurisdictions.

© 1998, 2002, 2004 and 2007 by Tyco Electronics Corporation. All Rights Reserved.

AMP, AMP-O-LECTRIC, AMP-O-MATIC, AMPLIMITE, the TE Logo and TYCO ELECTRONICS are trademarks.

Other products, logos, and company names mentioned herein may be trademarks of their respective owners.

**See inside back cover for Global Contacts and phone numbers.**

**Note:** Connectors are not designed to mate and unmate on energized line.

### Product Facts

- Connector system designed for exclusive use with I/O and power circuits in the power and control boards of heavy electric systems and FA equipment, process computers, FA computers, PCs, NCs, servodrivers, servomotors, inverters, switching power supplies, etc.
- Consists of wire-side connector and board-side connector
- Diverse housings are available to meet most specific applications
- With contacts standardized, the tool types used can be reduced
- Termination can be automated and field maintenance simplified
- As contacts can be crimped, connector quality is maintained
- Standardization of contacts leads to easier management of inventory
- To help prevent human errors in termination a common identification mark is on hand tools and contacts
- Housing color and design are coordinated

### Need more information?

Call Technical Support at the numbers listed below.

Technical Support is staffed with specialists well versed in Tyco Electronics products. They can provide you with:

- Technical Support
- Catalogs
- Technical Documents
- Product Samples
- Tyco Electronics Authorized Distributor Locations

### Restriction on the use of Hazardous Substances (RoHS)

At Tyco Electronics, we're ready to support your RoHS requirements. We've assessed more than 1.5 million end items/components for RoHS compliance, and issued new part numbers where any change was required to eliminate the restricted materials. Part numbers in this catalog are identified as:

**RoHS Compliant** — Part numbers in this catalog are RoHS Compliant, unless marked otherwise. These products comply with European Union Directive 2002/95/EC as amended 1 January 2006 that restricts the use of lead, mercury, cadmium, hexavalent chromium, PBB, and PBDE in certain electrical and electronic products sold into the EU as of 1 July 2006.

**NOTE:** For purposes of this Catalog, included within the definition of RoHS Compliant are products that are clearly "Out of Scope" of the RoHS Directive such as hand tools and other non-electrical accessories.

**NOTE:** Information regarding RoHS compliance is provided based on reasonable inquiry of our suppliers and represents our current actual knowledge based on the information provided by our suppliers. This information is subject to change. For latest compliance status, refer to our website referenced at right.

### Getting the Information You Need

Our comprehensive on-line RoHS Customer Support Center provides a forum to answer your questions and support your RoHS needs. A RoHS FAQ (Frequently Asked Questions) is available with links to more detailed information. You can also submit RoHS questions and receive a response within 24 hours during a normal work week. The Support Center also provides:

- Cross-Reference from Non-compliant to Compliant Products
- Ability to browse RoHS Compliant Products in our on-line catalog
- Downloadable Technical Data Customer Information Presentation
- More detailed information regarding the definitions used above
- So whatever your questions when it comes to RoHS, we've got the answers at [www.tycoelectronics.com/leadfree](http://www.tycoelectronics.com/leadfree)



**Table of Contents**

Product Facts ..... 2

Table of Contents ..... 3-5

**D-1000 Series**

Introduction and Product Facts ..... 6

D-1 Contacts (Strip and Loose Piece), Application Tooling,  
Performance Characteristics and Technical Documents ..... 7

**D-1100D — 2-Row Type**

Dimensions (Mating and External), Receptacle & Tab Housings and  
Board-mounting Tab Headers (Horizontal and Vertical) ..... 8, 9

**D-1200S**

Dimensions (Mating and External), 2-Pos. Receptacle & Tab Housings and  
Board-mounting Tab Header (Vertical) ..... 10, 11

**D-1200D — 2-Row Type**

Dimensions (Mating and External), Receptacle & Tab Housings and  
Board-mounting Tab Headers (Horizontal and Vertical) ..... 12, 13

**D-1500T**

Dimensions (Mating and External), 3-Pos. Receptacle Housing and  
Board-mounting Tab Headers (Horizontal and Vertical) ..... 14, 15

**D-2000 Series**

List of Products by Application (D-2100S, D-2100D and D-2100M) ..... 16

Performance Specifications ..... 17, 18

D-2 Contacts (Strip and Loose Piece) and Application Tooling ..... 19

**D-2100S — 1-Row Type**

Typical Applications, Mating Combinations and 3-Pos. Housings & Headers ..... 20

Keying ..... 21

Dimensions (Mating and External), 3-Pos. Receptacle & Tab Housings and  
3-Pos. Board-mounting Tab Headers (Vertical and Horizontal) ..... 22, 23

**D-2100D — 2-Row Type**

Typical Applications, Mating Combinations and Housings & Headers ..... 24

Keying ..... 25

Dimensions (Mating and External), Receptacle & Tab Housings and  
Board-mounting Tab Headers (Vertical and Horizontal) ..... 26, 27

**D-2100M**

**Drawer Type**

Typical Applications and 50-Pos. Receptacle & Tab Housings ..... 28

Dimensions (Mating and External), 50-Pos. Receptacle & Tab Housings ..... 29

50-Pos. Board-mounting Tab Header (Horizontal) ..... 30

Panel Mounting Screws (for 50-Pos. Receptacle & Tab Housings) ..... 30

**Screw Lock Type**

50-Pos. Receptacle and Tab Assemblies (with Screws) ..... 31

**D-2600 — Combination Power & Signal**

Introduction, Performance Characteristics and Technical Documents ..... 32

Dimensions (Mating and External), 48-Pos. Receptacle Housing and  
Board-mounting Tab Header (Vertical) ..... 33

**D-3000 Series**

List of Products by Application

D-3100S, D-3100M and D-3100D ..... 34

D-3200S, D-3200M and D-3200T; D-3400F and D-3500D ..... 35

Performance Specifications ..... 36, 37

D-3 Contacts (Strip and Loose Piece) ..... 38

Application Tooling (Hand Tools and Machines) ..... 38-41

Keying Plug ..... 41

Connector Panel-Mounting Hardware (L Fittings and Push Rivets) ..... 42

**Table of Contents** (Continued)

**D-3100S**  
**Standard 1-Row Type**  
 Typical Applications, Mating Combinations and Ordering Information . . . . . 43  
 Keying and Typical Applications (Elevators) . . . . . 44  
 Dimensions (Mating and External), Receptacle & Tab Housings and  
 Board-mounting Tab Headers (Horizontal and Vertical) . . . . . 45, 46  
**Standard SMT Type**  
 Mating Combinations and Ordering Information . . . . . 47  
 Dimensions (Mating and External), Receptacle Housings and  
 Board-mounting Tab Headers (Horizontal and Vertical) . . . . . 47, 48  
**D-3100D — Standard 2-Row Type**  
 Typical Applications, Mating Combinations and Ordering Information . . . . . 49  
 Dimensions (Mating and External), Receptacle & Tab Housings and  
 Board-mounting Tab Headers (Horizontal and Vertical) . . . . . 50, 51  
**D-3100M — Modular Type**  
 Typical Applications and 6-Pos. Receptacle Housings & Tab Headers . . . . . 52  
 Keying and Mating Combinations . . . . . 53  
 Dimensions (Mating and External), 6-Pos. Receptacle Housing and  
 6-Pos. Board-mounting Tab Headers (Horizontal and Vertical) . . . . . 54, 55  
**D-3200S**  
**High Voltage Version of Standard D-3100S**  
 Typical Applications, Mating Combinations and Ordering Information . . . . . 56  
 Keying and Typical Application (Switching Regulator) . . . . . 57  
 Dimensions (Mating and External), Receptacle & Tab Housings and  
 Board-mounting Tab Headers (Horizontal and Vertical) . . . . . 58, 59  
**SMT Type**  
 Typical Applications and Receptacle Housings & 3-Pos. Tab Header . . . . . 60  
 Dimensions (Mating and External), 3-Pos. Board-mounting Tab Header . . . . . 61  
**D-3200M**  
**Modular Type**  
 Typical Applications and Ordering Information . . . . . 62  
 Keying and Mating Combinations . . . . . 63  
 Dimensions (Mating and External), Receptacle & Tab Housings and  
 Board-mounting Tab Headers (Horizontal and Vertical) . . . . . 64, 65  
**Drawer Type**  
 Typical Applications, Mating Combinations and Ordering Information . . . . . 66  
 Dimensions (Mating and External), 6-Pos. Receptacle & Tab Housings and  
 6-Pos. Board-mounting Tab Headers (Horizontal and Vertical) . . . . . 67, 68  
**D-3200T — 3-Row Type**  
 Typical Application and 9-Pos. Board-mounting Tab Headers,  
 Dimensions (Mating and External) and Keying . . . . . 69  
**D-3400F — Skyscraper Connectors**  
 Typical Applications, Mating Combinations and Ordering Information . . . . . 70  
 Dimensions (Mating and External), Receptacle Housings and  
 Board-mounting Tab Headers (Horizontal) . . . . . 71, 72  
**D-3500D — Sensor Connectors**  
 Typical Applications, Mating Combinations and Ordering Information . . . . . 73  
 Dimensions (Mating and External), Receptacle & Tab Housings and  
 Board-mounting Tab Headers (Horizontal and Vertical) . . . . . 74, 75  
**D-3700 — Connectors for Exclusive Use with Servomotors**  
 Typical Applications, 6-Pos. Receptacle Connector Kits . . . . . 76  
 Dimensions (Mating and External) and Optional Motor-side Tab Header . . . . . 77

**Table of Contents** (Continued)

<b>D-4000 Series</b>	
Introduction, Product Facts, Performance Characteristics and	
D-4 Contacts (Strip and Loose Piece) and Application Tooling . . . . .	78
<b>D-4200</b>	
Dimensions (Mating and External), Receptacle & Tab Housings and	
Board-mounting Tab Headers (Vertical) . . . . .	79, 80
<b>D-5200 Series</b>	
List of Products by Application (D-5200S and D-5200M) . . . . .	81
Performance Data and Specifications . . . . .	82, 83
D-5 Contacts (Strip and Loose Piece) and Sequential Clip . . . . .	84
Application Tooling (Extraction Tool, Hand Crimping Tool and Machine) . . . . .	84, 85
<b>D-5200S — Standard 1-Row Type</b>	
Typical Applications, Mating Combinations and Ordering Information . . . . .	86
Keying and Servomotor/Servodriver Application . . . . .	87
Dimensions (Mating and External), Receptacle & Tab Housings and	
Board-mounting Tab Headers (Horizontal, Vertical and Sequential) . . . . .	88, 89
<b>D-5200M — Modular Type</b>	
Typical Applications and Ordering Information . . . . .	90
Keying and Mating Combinations . . . . .	91
Dimensions (Mating and External), 4- and 6-Pos. Receptacle & Tab Housings and	
4- and 8-Pos. Board-mount Tab Headers (Horizontal) . . . . .	92, 93
<b>D-5200M<math>\alpha</math> — High Current Type</b>	
Typical Applications, Mating Combinations, Ordering Information and Keying . . . . .	94
Dimensions (Mating and External), Receptacle Housings and	
Board-mounting Tab Header (Horizontal) . . . . .	95, 96
<b>DZ-5200 — Board-to-Board</b>	
Performance Characteristics, External Dimensions, and	
Receptacle Header (Vertical) . . . . .	97
Tab Header (Horizontal) . . . . .	98
<b>D-5300 — Panel Mount Type</b>	
Introduction and Performance Characteristics . . . . .	99
Dimensions (Mating and External), Panel Mount Receptacle & Tab Housing . . . . .	100
<b>AMP Dynamic with HTS Connectors</b>	
Introduction, Performance Characteristics and Contacts (D-2 and D-3) . . . . .	101
<b>D-2800</b> , 30-Pos. Receptacle & Tab Housings . . . . .	102
<b>D-3800</b> , 12-Pos. Receptacle & Tab Housings . . . . .	102
HTS Modular Frames and Metal Housings (Sizes 3, 4, 6 and 8) . . . . .	104
HTS Cable Gland Fittings (Plastic and Metal) . . . . .	105
<b>Power Connector — Board-to-Board</b>	
Specifications, Typical Applications and Ordering Information . . . . .	106
Dimensions (Mating and External) . . . . .	107
<b>Dyna-Tap Connectors</b>	
<b>D-3100</b> , 18-Pos. Introduction, Applications and Performance Characteristics . . . . .	108
Dimensions (Mating and External), 18-Pos. Tab Housing and	
6-Pos. Receptacle Housing . . . . .	109
<b>D-3200</b> , 24-Pos. Introduction and Performance Characteristics . . . . .	110
Dimensions (Mating and External), 24-Pos. Tab Housing and	
4-Pos. Receptacle Housing . . . . .	111
<b>Dyna-Clamp Kit</b>	
Introduction, Applications and Performance Characteristics . . . . .	112
Dimensions (Mating and External), 3-Pos. Cable Clamp Kit and Mating Connectors . . . . .	113
<b>Part Number Index</b> . . . . .	114, 115
<b>Global Contacts</b> . . . . .	119

## D-1000 Series (Wire-to-Board, Wire-to-Panel and Wire-to-Wire)

### Product Facts

- Header and tab connectors have enough length from the tip of contact to top of housing to help prevent contact from bending when receptacle mates to tab connector.
- D-1000 has housing lance structure. Without contact lance, it is expected to avoid contact lance broken in terminal process handling
- Clear identification of circuit number provides for correct wiring
- Metal retention leg assembly tab header helps prevent damage from unexpected cable tension
- Housing lock design

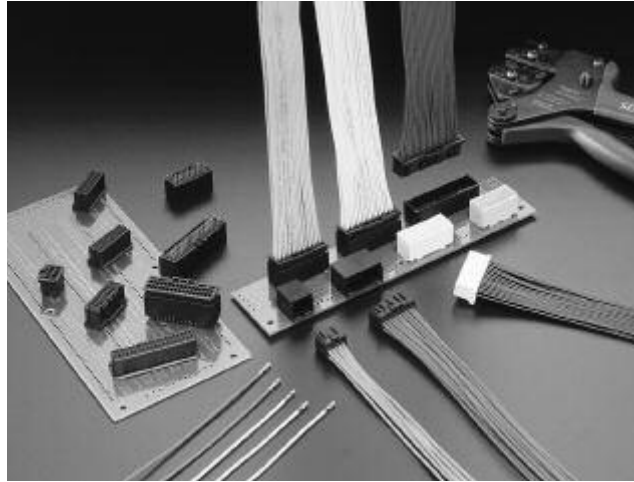
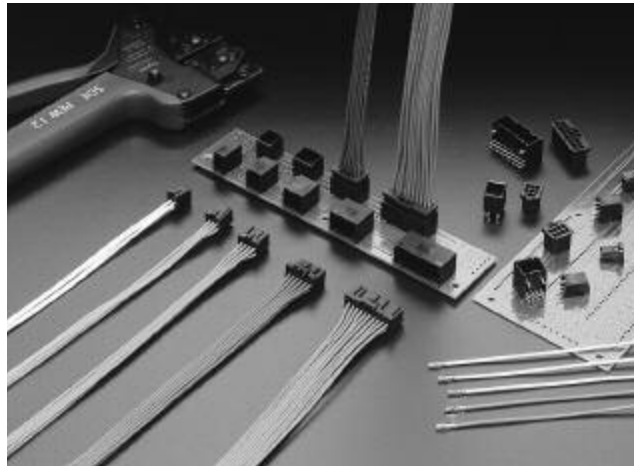
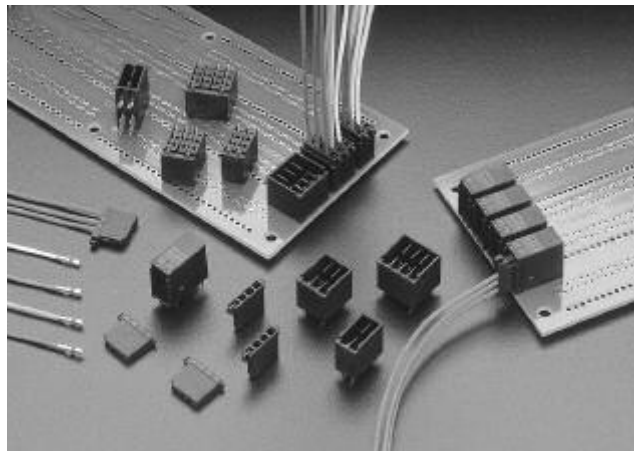
**D-1100**

**D-1200**

**D-1500**

D-1000 Series are the smallest connectors for signal lines in the Dynamic connector series. D-1000 Series occupies 40% less volume than the D-2000 Series, so it can contribute to customers' equipment miniaturizing requirement.

D-1000 Series receptacle and tab contacts have a wide wire range, 30 through 18 AWG with 2.2 mm wire insulation diameter maximum, which is commonly used for electrical cabinet wiring.

D-1000 Series housings consist of D-1110 Series for 2.0 mm centerline and D-1200 Series for 2.5 mm centerline as the standard type. In addition, D-1500 Series housings are for 3.5 mm centerline sensor applications or branch connection of power lines.

D-1000 Series has gold plated contacts as standard and also tin plated contacts for economical market needs. Customers have a choice of contacts depending on specifications, application, and cost.

Crimping hand tool features a changeable die set structure. It offers minimal installation tooling cost. This tooling system will evolve to D-2000, D-3000 and D-4000 Series in the future.

**D-1000 Series** (Continued)

**D-1 Contact and Performance Specifications**
**Crimp Type**

Applicable Wire Range		Wire Ins. Diameter mm	Wire Range Mark	Style	Contact Part Numbers				Tool Numbers		
AWG	mm <sup>2</sup>				Receptacle Contact	Tab Contact		Mini Applicator	Hand Tool <sup>1</sup> (Dies Only)		
					Gold Plating	Tin Plating	Gold Plating	Tin Plating			
30	0.05	0.6~1.2	S	Strip Form	1827569-2	—	1903111-2	—	1891033-2	—	
28	0.09			Loose Piece	1827586-2	—	1903115-2	—	—	1762952-1 (1762953-1)	—
28	0.08	1.08~1.6	M	Strip Form	1827570-2	1871303-1	1903112-2	1903120-1	1891035-2	—	
26	0.12			Loose Piece	1827587-2	1871743-1	1903116-2	1903124-1	—	1762846-1 (1762847-1)	—
24	0.20				Strip Form	1827571-2	1871304-1	1903113-2	1903121-1	1891036-2	—
22	0.38			Loose Piece		1827588-2	1871744-1	1903117-2	1903125-1	—	1762950-1 (1762951-1)
28	0.08	1.08~1.9	L	Strip Form	1827571-2	1871304-1	1903113-2	1903121-1	1891036-2	—	
26	0.12			Loose Piece	1827588-2	1871744-1	1903117-2	1903125-1	—	1762950-1 (1762951-1)	
24	0.20				Strip Form	1827572-2	1871731-1	1903114-2	1903122-1	1891037-2	—
22	0.38			Loose Piece		1827589-2	1871745-1	1903118-2	1903126-1	—	1762625-1 (1762626-1)
22	0.34	1.4~2.2	2L	Strip Form	1827572-2	1871731-1	1903114-2	1903122-1	1891037-2	—	
20	0.50			Loose Piece	1827589-2	1871745-1	1903118-2	1903126-1	—	1762625-1 (1762626-1)	
18	0.86										

**Notes:** Minimum order quantity for tooling is one.

Tin plating: 2.0 µm.

Mini-Applicators are for use with automachines. (For more information, contact Technical Support at the numbers listed below.)

Strip Form contacts are for use with Mini-Applicators (automachines) and Loose-Piece contacts are for Hand tools.

The contacts L and 2L do **not** fit into the D-1100 receptacle housing.

<sup>1</sup> With handle.

**Performance Characteristics**

Series —	D-1100	D-1200	D-1500
<b>Pitch</b> —	2.0 mm	2.5 mm	3.5 mm
<b>Voltage Rating</b> —	125 VAC	250 VAC	250 VAC
<b>Current Rating (Max.)</b> —	Pos. :3A (AWG 22 wire)	Pos. :5A (AWG 18 wire)	Pos. :5A (AWG 18 wire)
<b>Contact Resistance</b> —	20 mΩ max.	20 mΩ max.	20 mΩ max.
<b>Dielectric Withstanding Voltage</b> —	700 V	1100 V	1100 V
<b>Temperature Range</b> —	-55°C~+105°C	-55°C~+105°C	-55°C~+105°C

\*When connectors are used singly.

**Material and Finish**

**Receptacle Contact** — Copper alloy, 0.38 µm gold plated over 1.27 µm nickel underplate

**Tab Contact** — Copper alloy, 0.38 µm gold plated over 1.27 µm nickel underplate

**PCB Tab Post** — Copper alloy, 0.38 µm gold plated over 1.27 µm nickel underplate, Tab Post 2.0 µm tin plated

**Housing** — Glass-filled polyester (PBT), UL94V-0

**Specifications and Instruction Sheets**
**Product Specifications**

108-78268 (Gold plating)

108-78298 (Tin plating)

**Application Specification**

114-5377

**Crimping Tool Instruction Sheets**

411-78194 (Part Number 1762625-1)

411-78201 (Part Number 1762846-1)

411-78204 (Part Number 1762950-1)

411-78205 (Part Number 1762952-1)

**Safety Specifications for D-1000 Series**

	Voltage Rating	Current Rating	Temperature Rating
<b>Tyco Electronics Specifications</b>	125 VAC (2 mm)	3A (1 position)	-55°C~+105°C
<b>108-78268</b> —	250 VAC (2.5 mm)	5A (1 position)	
	250 VAC (3.5 mm)		

**UL File Number** — E 28476

**CSA Report Number** — Pending Approval

**TUV License Number** — Pending Approval

**D-1000 Series** (Continued)

D-1000 Series

**D-1100D**

**Mating Dimensions**

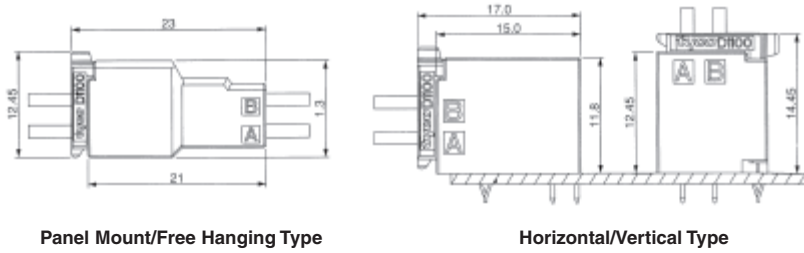

**External Dimensions**

**Receptacle Housing**

No. of Pos.	Color	Part No.	Dimensions	
			A	B
10	Black	1-1827862-5	12.6	10.9
20	Black	1-1827862-0	22.6	20.9
22	Black	1-1827863-1	24.6	22.9
	Yellow	3-1871057-1		
26	Black	1-1827863-3	28.6	26.9
	Natural	1-1871057-3		
28	Black	1-1827863-4	30.6	28.9
30	Black	1-1827863-5	32.6	30.9
	Natural	1-1871057-5		
	Yellow	3-1871057-5		
32	Black	1-1827863-6	34.6	32.9
34	Black	1-1827863-7	36.6	34.9
40	Black	1-1827863-0	42.6	40.9

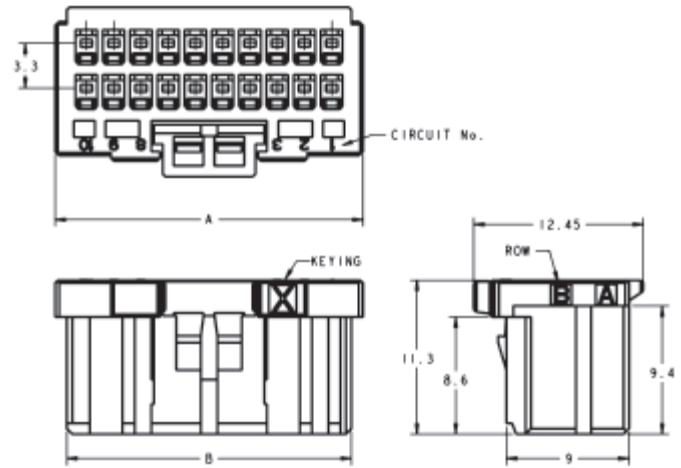

**Tab Housing**

**Panel Mount Type/  
Free Hanging Type**

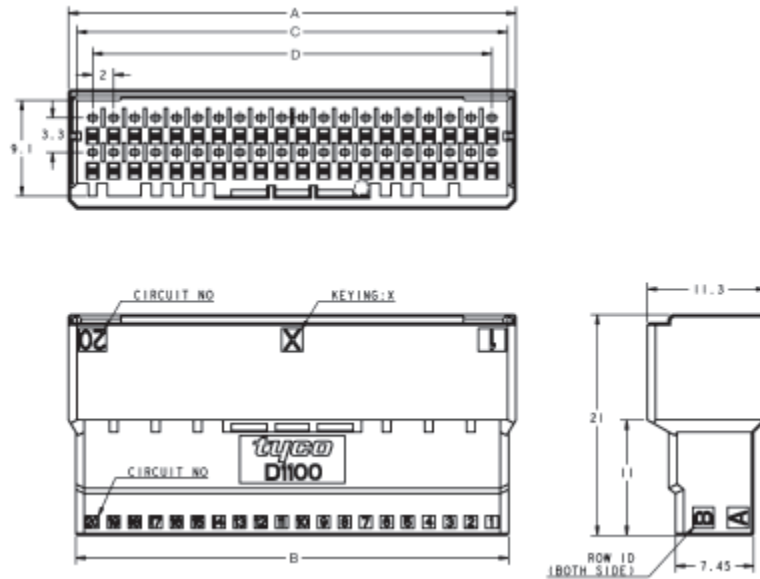

No. of Pos.	Part No.		Dimensions			
	Panel Mount Type	Free Hanging Type	A	B	C	D
22	1-1903128-1	1-1903127-1	24.6	23.2	23.0	20.0
26	1-1903128-3	1-1903127-3	28.6	27.2	27.0	24.0
28	1-1903128-4	1-1903127-4	30.6	29.2	29.0	26.0
32	1-1903128-6	1-1903127-6	34.6	33.2	33.0	30.0
34	1-1903128-7	1-1903127-7	36.6	35.2	35.0	32.0
40	1-1903128-0	1-1903127-0	42.6	41.2	41.0	38.0



**D-1000 Series** (Continued)

**D-1100D**

**Board Mount Tab Header  
(Horizontal Type)**

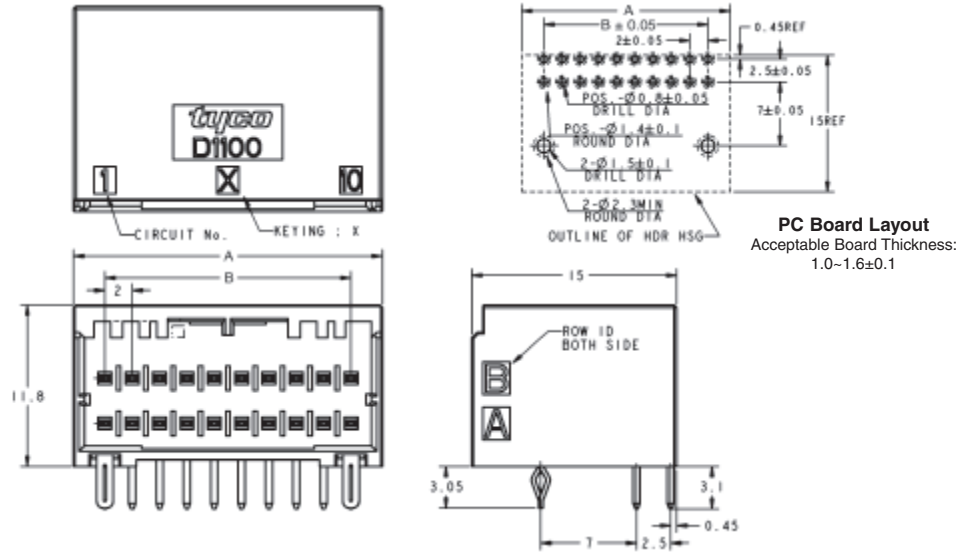

No. of Pos.	Part No.	Dimensions	
		A	B
10	1-1827873-5	12.6	8.0
20	1-1827873-0	22.6	18.0

**Board Mount Tab Header  
(Vertical Type)**

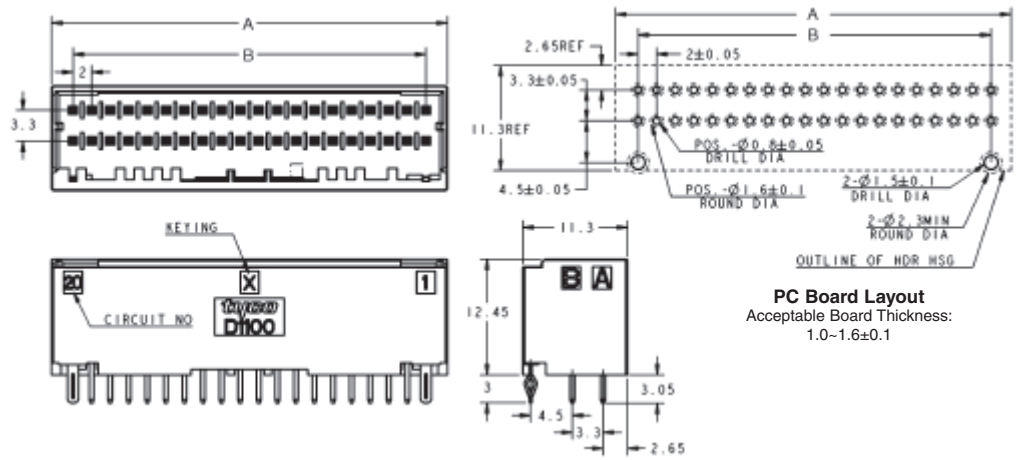

No. of Pos.	Plating	Color	Part No.	Dimensions	
				A	B
22	Gold	Black	1-1827872-1	24.6	20.0
	Tin	Yellow	3-1871056-1		
26	Gold	Black	1-1827872-3	28.6	24.0
	Tin	Natural	1-1871056-3		
28	Gold	Black	1-1827872-4	30.6	26.0
	Gold	Black	1-1827872-5		
30	Tin	Black	1-1871315-5	32.6	28.0
	Tin	Natural	1-1871056-5		
	Tin	Yellow	3-1871056-5		
32	Gold	Black	1-1827872-6	34.6	30.0
34	Gold	Black	1-1827872-7	36.6	32.0
40	Gold	Black	1-1827872-0	42.6	38.0
	Tin	Black	1-1871315-0		

**D-1000 Series** (Continued)

D-1000 Series

**D-1200S**

**Mating Dimensions**

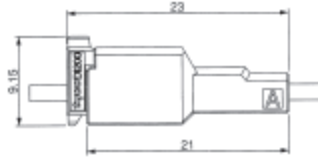

Free Hanging Type

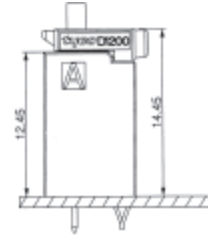

Vertical Type

**Dimensions**

**Receptacle Housing**

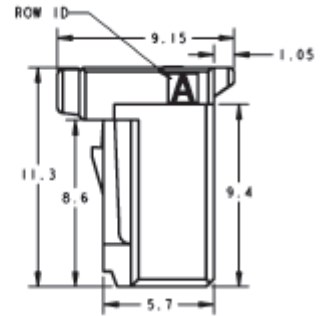
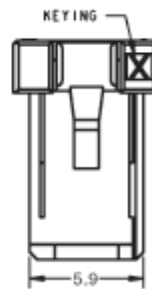
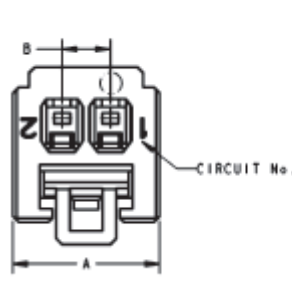

No. of Pos.	Keying	Part No.	Dimensions	
			A	B
2	X	1-1871465-2	7.6	2.5
	Y	—	—	—

**Board Mount Tab Header (Vertical Type)**

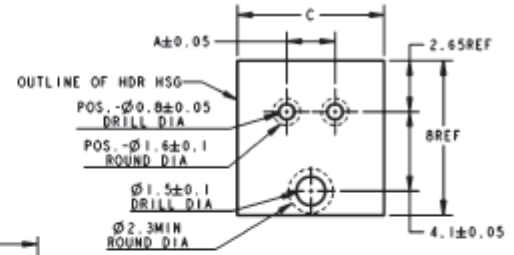
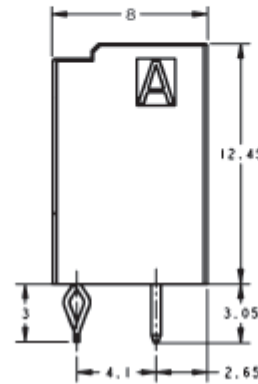
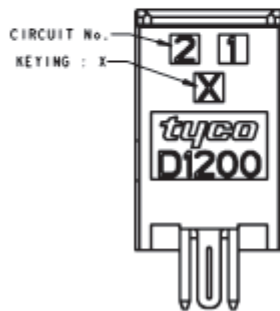
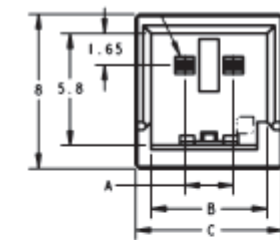

**PC Board Layout**  
Acceptable Board Thickness:  
1.0-1.6±0.1

No. of Pos.	Keying	Part No.	Dimensions		
			A	B	C
2	X	1-1871468-2	2.5	6.0	7.6
	Y	—	—	—	—

**D-1000 Series** (Continued)

**D-1200S**

Tab Housing  
Free Hanging Type

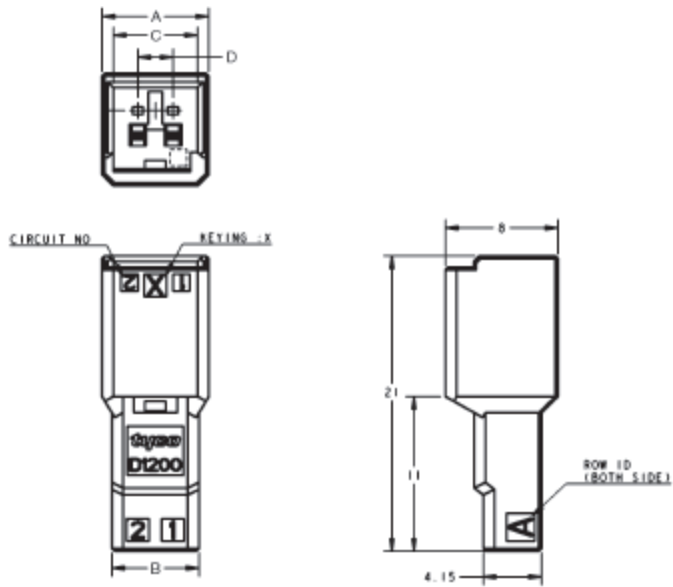

No. of Pos.	Keying	Part No.	Dimensions			
		Free Hanging Type	A	B	C	D
2	X	1-1903129-2	7.6	6.2	6.0	2.5
	Y	—	—	—	—	—

**D-1000 Series** (Continued)

D-1000 Series

**D-1200D**

**Mating Dimensions**

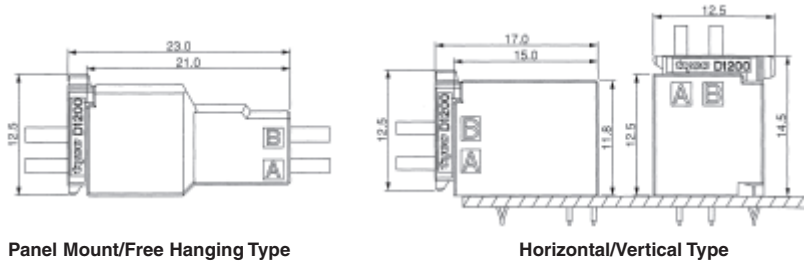

**Dimensions**

**Receptacle Housing**

No. of Pos.	Keying	Part No.	Dimensions			
			A	B	C	D
4	X	1-1827864-2	7.6	2.5	—	5.9
	Y	2-1827864-2				
6	X	1-1827864-3	10.1	5.0	8.4	8.4
	Y	2-1827864-3				
8	X	1-1827864-4	12.6	7.5	10.9	10.9
	Y	2-1827864-4				
10	X	1-1827864-5	15.1	10.0	10.9	13.4
	Y	2-1827864-5				
12	X	1-1827864-6	17.6	12.5	15.9	15.9
	Y	2-1827864-6				
20	X	1-1827864-0	27.6	22.5	15.9	25.9
	Y	2-1827864-0				

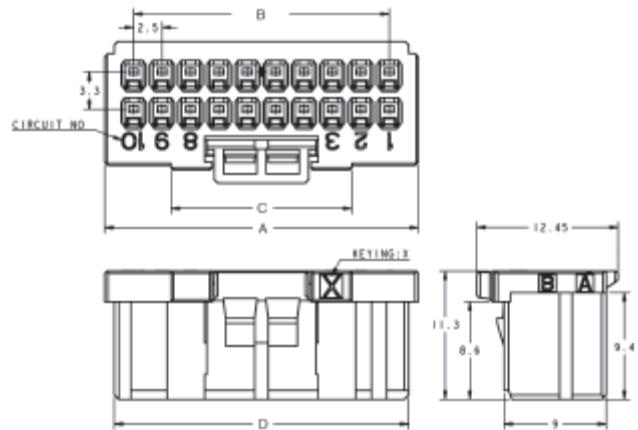

**Board Mount Tab Header (Vertical Type)**

No. of Pos.	Keying	Part No.	Dimensions	
			A	B
4	X	1-1827875-2	7.6	2.5
	Y	2-1827875-2		
6	X	1-1827875-3	10.1	5.0
	Y	2-1827875-3		
8	X	1-1827875-4	12.6	7.5
	Y	2-1827875-4		
10	X	1-1827875-5	15.1	10.0
	Y	2-1827875-5		
12	X	1-1827875-6	17.6	12.5
	Y	2-1827875-6		
20	X	1-1827875-0	27.6	22.5
	Y	2-1827875-0		

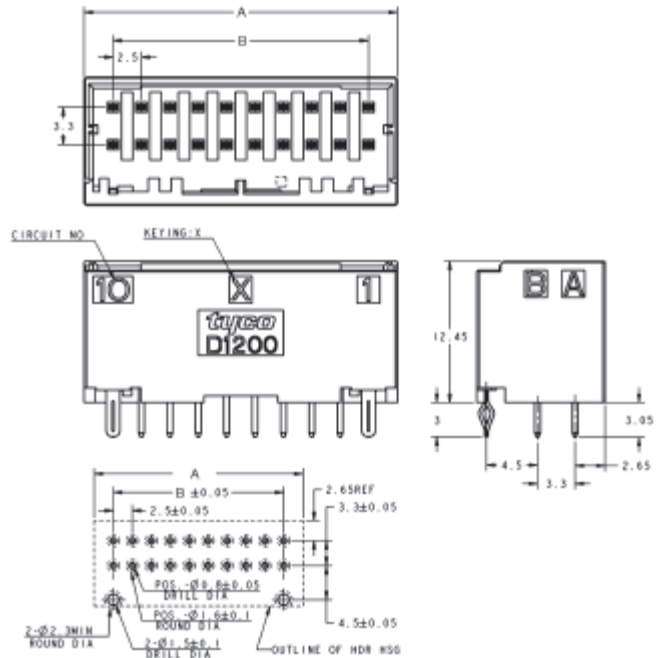

**PC Board Layout**  
Acceptable Board Thickness:  
1.0-1.6±0.1

**D-1000 Series** (Continued)

**D-1200D**

**Board Mount Tab Header  
(Horizontal Type)**

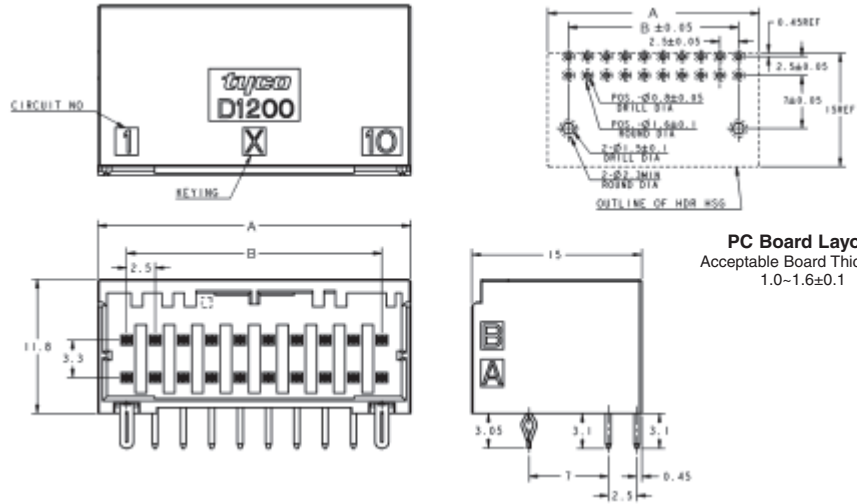

No. of Pos.	Part No.	Dimensions	
		A	B
4	1-1827876-2	7.6	2.5
	1-1871673-2*		
6	1-1827876-3	10.1	5.0
8	1-1827876-4	12.6	7.5
12	1-1827876-6	17.6	12.5
	1-1871673-6*		
20	1-1827876-0	27.6	22.5

\* Marked tab posts are tin plated. Other tab posts are gold plated.

**Tab Housing**

**Panel Mount Type/  
Free Hanging Type**

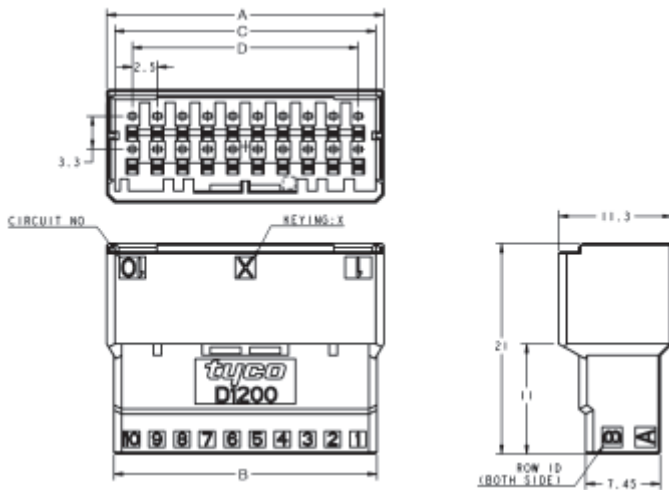

No. of Pos.	Part No.		Dimensions			
	Panel Mount Type	Free Hanging Type	A	B	C	D
4	1-1903131-2	1-1903130-2	7.6	6.2	6.0	2.5
6	1-1903131-3	1-1903130-3	10.1	8.7	8.5	5.0
8	1-1903131-4	1-1903130-4	12.6	11.2	11.0	7.5
12	1-1903131-6	1-1903130-6	17.6	16.2	16.0	12.5
20	1-1903131-0	1-1903130-0	27.6	26.2	26.0	22.5

Please contact Technical Support about Y-Key.

**D-1000 Series** (Continued)

D-1000 Series

**D-1500T**

**Mating Dimensions**

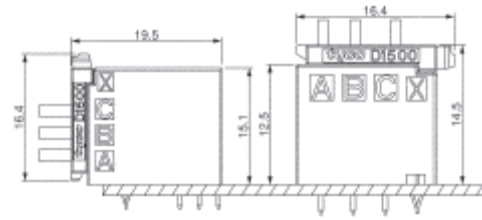

Horizontal/Vertical Type

**Dimensions**

**Receptacle Housing**

No. of Pos.	Part No.	Dimensions	
		A	B
3	1-1827579-1	16.35	12.3

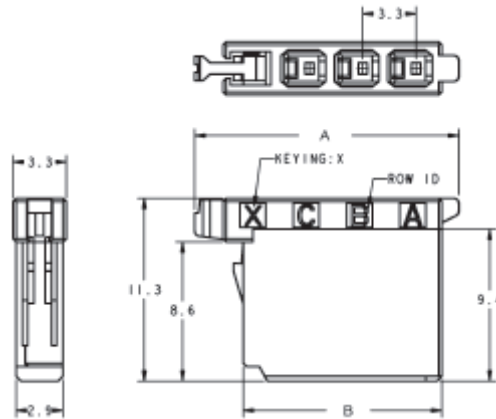

**Board Mount Tab Header (Vertical Type)**

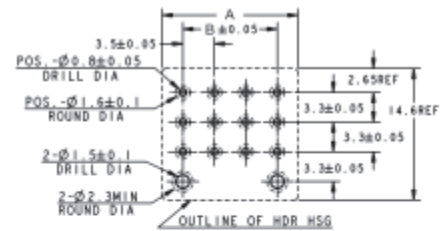
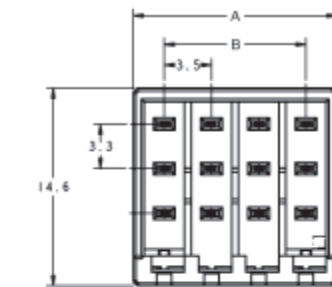

**PC Board Layout**  
Acceptable Board Thickness: 1.0-1.6±0.1

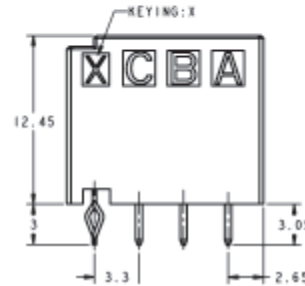
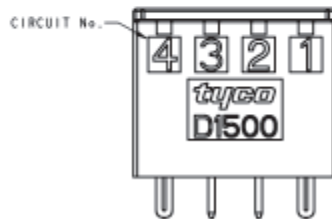

No. of Pos.	Part No.	Dimensions	
		A	B
6	1-1827581-2	8.1	3.5
9	1-1827581-3	11.6	7.0
12	1-1827581-4	15.1	10.5

**D-1000 Series** (Continued)

**D-1500T**

Board Mount Tab Header  
(Horizontal Type)

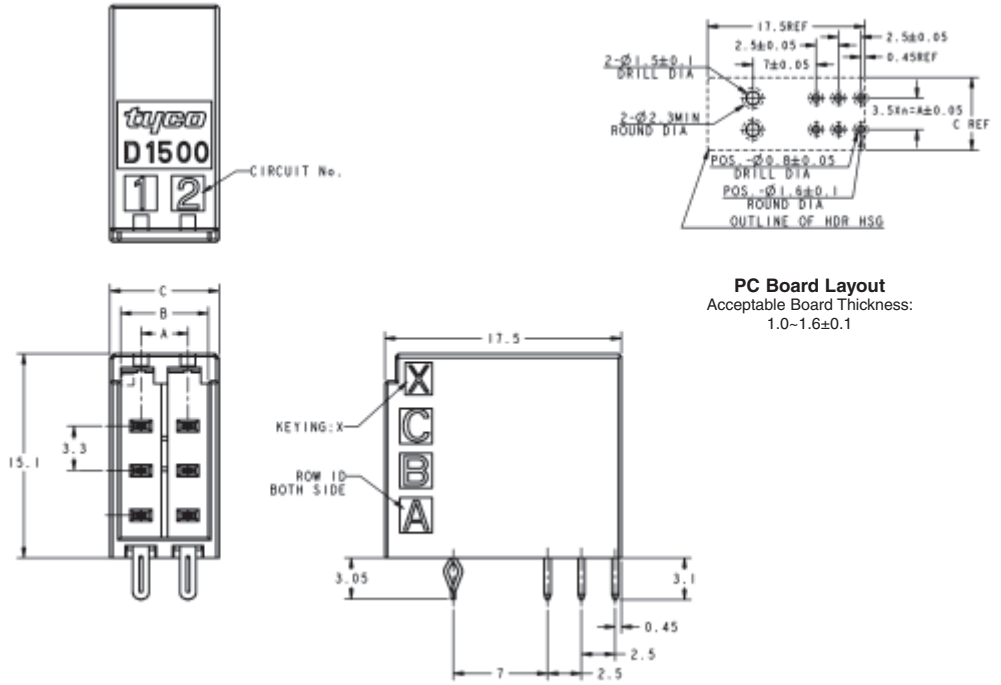

**PC Board Layout**  
Acceptable Board Thickness:  
1.0-1.6±0.1

No. of Pos.	Part No.	Dimensions		
		A	B	C
6	1-1827583-2	3.5	6.5	8.1