

SUPER RED MV8102 CLEAR
SUPER RED MV8103 CLEAR
SUPER RED MV8104 CLEAR

PACKAGE DIMENSIONS

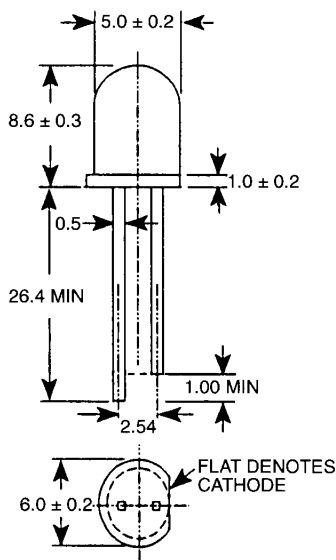

ST1760

NOTES:

1. ALL DIMENSIONS ARE IN MILLIMETERS
2. LEAD SPACING IS MEASURED WHERE THE LEADS EMERGE FROM THE PACKAGE
3. PROTRUDED RESIN UNDER FLANGE IS 1.5 mm (0.059") MAX.

DESCRIPTION

These T-1¾ super bright LEDs have a narrow 20° viewing angle for concentrated light output. The MV8101/2/3/4 are made with GaAlAs LEDs on a GaAlAs substrate. They are all encapsulated in an epoxy package and have water clear lenses.

FEATURES

- Outstanding material efficiency
- Popular T-1¾ package
- Low drive current
- Solid state reliability
- Super high brightness suitable for outdoors applications
- Standard 1 mil. lead spacing

ABSOLUTE MAXIMUM RATING (T_a = 25°C Unless Otherwise Specified)

DC forward current (I _f)	40 mA
Operating temperature range	-40°C to +85°
Storage temperature range	-40°C to +100°C
Lead soldering time	5 seconds @ 260°C
(at 1/16 inch from bottom of lamp)	
Peak forward current	200 mA
(at f=1.0 KHz, Duty factor=1/10)	
Power dissipation (P _d)	110 mW
Recommended operating current (I _f Rec)	20 mA

ELECTRO-OPTICAL CHARACTERISTICS ($T_A = 25^\circ\text{C}$ Unless Otherwise Specified)					
PARAMETER	MIN.	TYP.	MAX.	UNITS	TEST CONDITIONS
Luminous intensity					
MV8102	250	370		mcd	$I_F = 20\text{ mA}$
MV8103	630	940		mcd	$I_F = 20\text{ mA}$
MV8104	1000	1500		mcd	$I_F = 20\text{ mA}$
Forward voltage	1.5	1.7	2.4	V	$I_F = 20\text{ mA}$
Peak wavelength		660		nm	$I_F = 20\text{ mA}$
Spectral line half width		40		nm	$I_F = 20\text{ mA}$
Reverse breakdown voltage		5		V	$I_R = 10\ \mu\text{A}$
Viewing angle		20		degree	$I_F = 20\text{ mA}$

TYPICAL ELECTRO-OPTICAL CHARACTERISTIC CURVES ($T_A = 25^\circ\text{C}$)

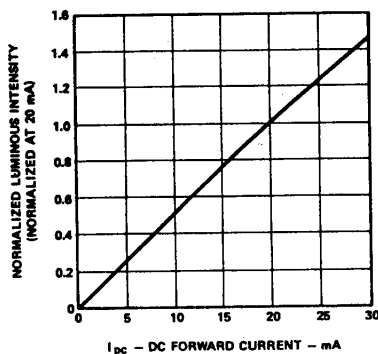

Fig. 1. Relative Luminous Intensity vs. DC Forward Current ST1002

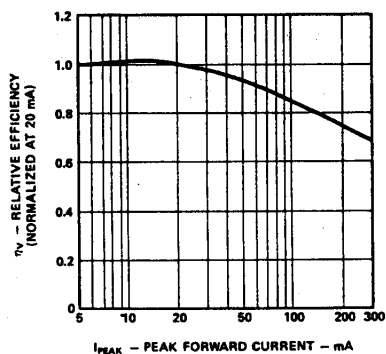

Fig. 2. Relative Efficiency vs. Peak Forward Current ST1761

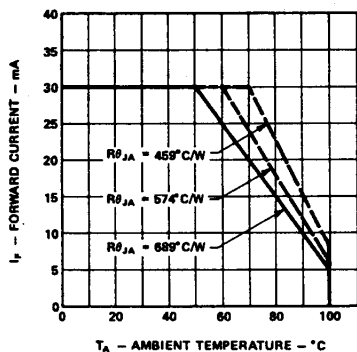

Fig. 3. Maximum Forward DC Current vs. Ambient Temperature Derating Based On $T_{JMAX} = 110^\circ$ ST1762

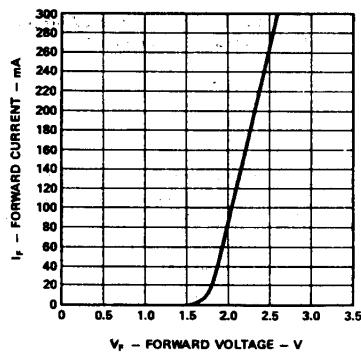

Fig. 4. Forward Current vs. Forward Voltage ST1763

TYPICAL ELECTRO-OPTICAL CHARACTERISTIC CURVES ($T_A=25^\circ\text{C}$)

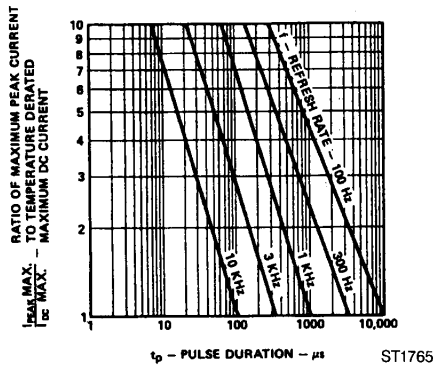

Fig. 5. Maximum Peak Current vs. Pulse Duration

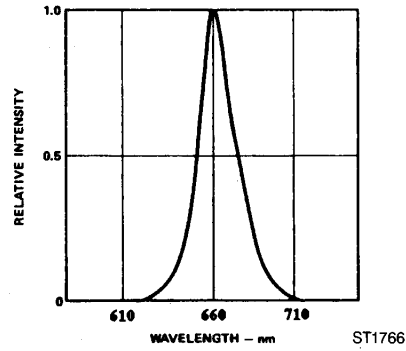

Fig. 6. Relative Intensity vs. Wavelength

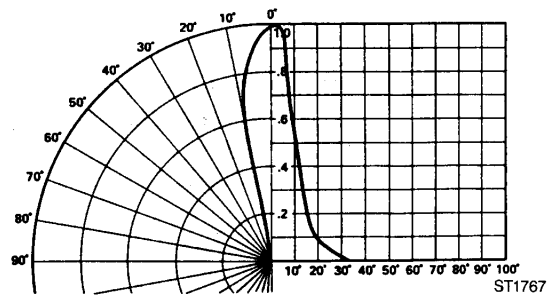

Fig. 7. Relative Luminous Intensity vs. Angular Displacement



SUPER BRIGHT T-1 $\frac{3}{4}$ (5mm) LED LAMPS

DISCLAIMER

FAIRCHILD SEMICONDUCTOR RESERVES THE RIGHT TO MAKE CHANGES WITHOUT FURTHER NOTICE TO ANY PRODUCTS HEREIN TO IMPROVE RELIABILITY, FUNCTION OR DESIGN. FAIRCHILD DOES NOT ASSUME ANY LIABILITY ARISING OUT OF THE APPLICATION OR USE OF ANY PRODUCT OR CIRCUIT DESCRIBED HEREIN; NEITHER DOES IT CONVEY ANY LICENSE UNDER ITS PATENT RIGHTS, NOR THE RIGHTS OF OTHERS.

LIFE SUPPORT POLICY

FAIRCHILD'S PRODUCTS ARE NOT AUTHORIZED FOR USE AS CRITICAL COMPONENTS IN LIFE SUPPORT DEVICES OR SYSTEMS WITHOUT THE EXPRESS WRITTEN APPROVAL OF THE PRESIDENT OF FAIRCHILD SEMICONDUCTOR CORPORATION. As used herein:

1. Life support devices or systems are devices or systems which, (a) are intended for surgical implant into the body, or (b) support or sustain life, and (c) whose failure to perform when properly used in accordance with instructions for use provided in the labeling, can be reasonably expected to result in a significant injury of the user.
2. A critical component in any component of a life support device or system whose failure to perform can be reasonably expected to cause the failure of the life support device or system, or to affect its safety or effectiveness.