

SPECIFICATION

Part No. : **G24.A.305111**

Product Name : G24 Ultima Series – Super Low Profile
Penta Band Cellular Antenna Screw-mount
GSM/GPRS/CDMA/HSPA
(Permanent mount)

Feature : Height 19.6mm(0.77”) and diameter 55mm(2.16”)
Heavy duty screw mount
UV and vandal resistant ABS housing and thread
IP67 compliant
Standard is 3 meter low loss cable CFD200 SMA(M)
Cables and Connectors Customizable
ROHS Compliant



1. Introduction

G24 Ultima Series Cellular Antenna is an extremely low profile 2G/3G 800MHz to 2200MHz cellular antenna solution for professional telematics applications. Suitable for GSM/GPRS/CDMA applications worldwide, at only 19.6mm (0.77") in height it is the lowest profile antenna in the market, with a diameter of only 55 mm (2.16"). It works well when mounted on both metal and non-metal. In other words it does not need a metal ground-plane to attach to, to radiate, something that competitor antennas all need.

Durable UV ABS housing, thread and nut is resistant to vandalism and direct attack.

The IP67 waterproof robust plastic body makes it extremely light, economical for shipping and minimum weight impact on vehicles. This also makes it ideal for use in humid environments such as water pits or marine applications as there are no metal parts to corrode. The closed cell foam with double-sided adhesive provides a permanent waterproof seal and can adjust to different curvatures, stopping water from leaking under the antenna into the mounting hole. Lowest loss PTFE cable is used for maximum gain and reduced noise entry through the cable.

Also available in White.

2. Specification

CELLULAR					
Frequency (MHz)	824 ~ 896	880 ~ 960	1710 ~ 1880	1850 ~ 1990	1710 ~ 2170
Peak Gain (dBi)					
Free space	2.0	1.8	3.9	3.9	3.9
10x10cm ground plane	-0.6	0.7	-0.2	1.7	1.7
20x20cm ground plane	1.8	1.8	3.1	3.1	3.1
30x30cm ground plane	0.0	0.0	1.7	1.7	2.0
Average Gain (dBi)					
Free space	-4.1	-4.0	-2.7	-2.8	-2.7
10x10cm ground plane	-4.8	-3.3	-4.9	-4.0	-4.0
20x20cm ground plane	-4.3	-4.3	-4.2	-4.0	-4.0
30x30cm ground plane	-6.3	-6.6	-4.4	-4.4	-4.4
Efficiency (%)					
Free space	39.1	39.3	53.4	52.5	53.4
10x10cm ground plane	33.8	46.2	32.1	40.0	40.0
20x20cm ground plane	36.9	36.9	37.8	39.3	39.3
30x30cm ground plane	23.4	23.4	36.0	36.0	36.0
Polarization	Linear				
Radiation Pattern	Omni				
Input Power	50Ω				
MECHANICAL					
Dimensions	Φ55±2mm , Height 30±2 mm, Profile 19.6mm Ø2.16"; Height 1.18"; Profile 0.77"				
Cable type	CFD200				
Cable length	3000±30mm(9' 10 ¹ / ₈ "±1.18")				
Casing	ABS				
Connector	SMA Male				
ENVIRONMENTAL					
Temperature Range	-40°C to 85°C				
Waterproof	IP-67				
Thermal Shock	100 cycles -40°C to +80°C				
Shock (drop test)	1m drop on concrete 6 axes				
Humidity	Non-condensing 65°C 95% RH				



3. Antenna Characteristics

3.1 Cellular antenna SWR

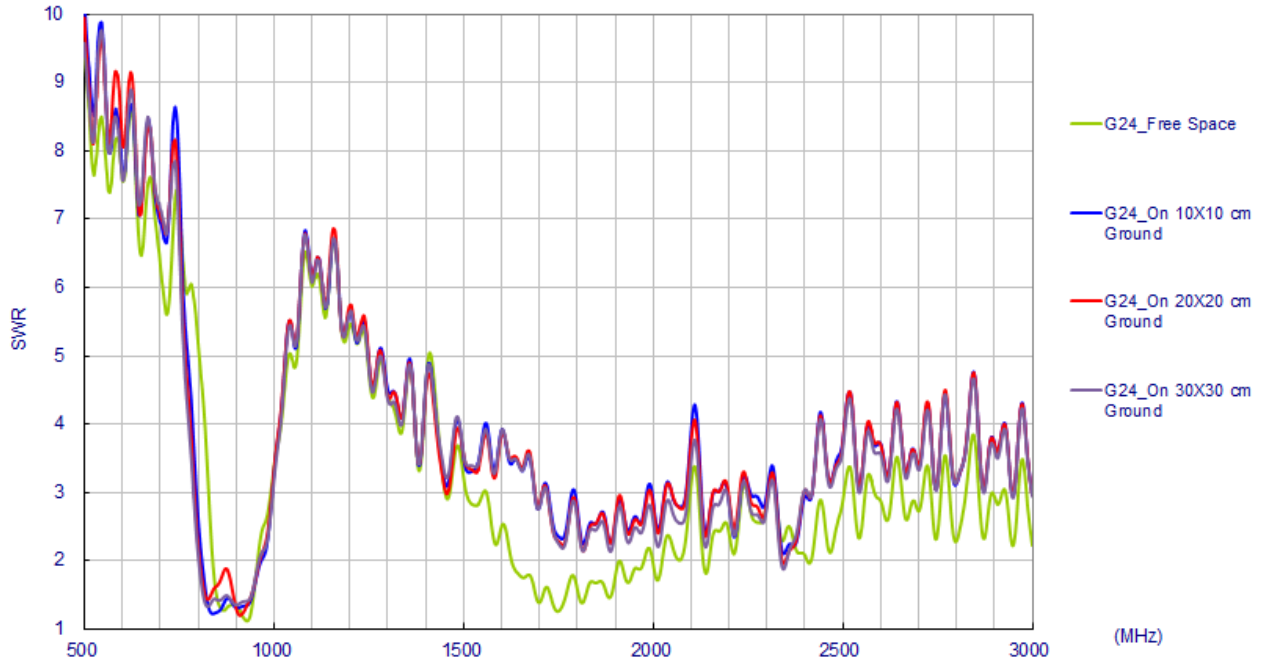

3.2 Antenna Efficiency

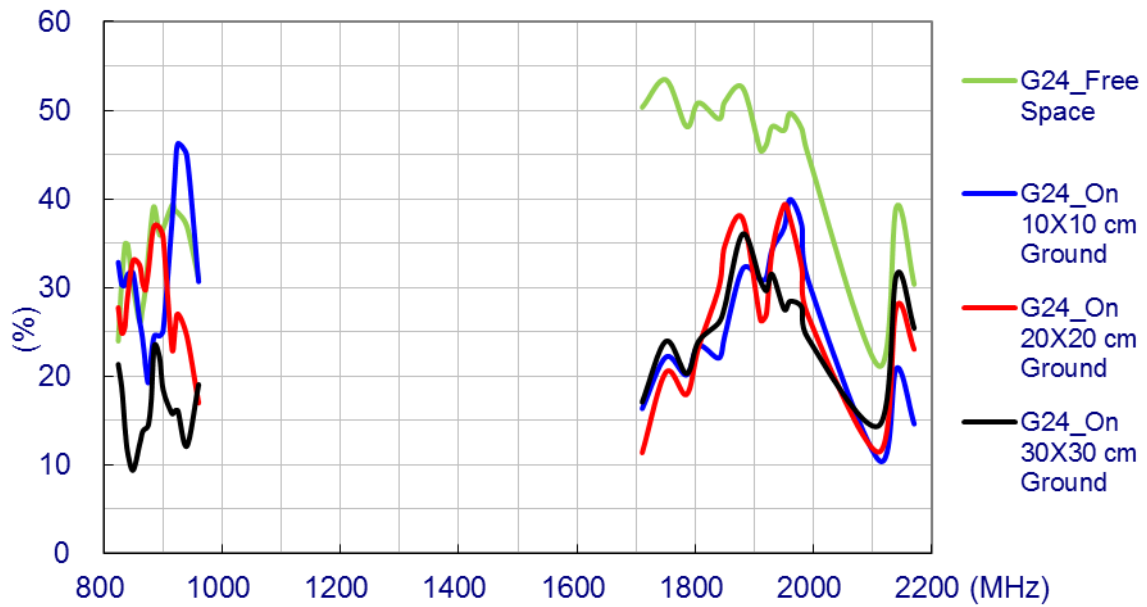

3.3 Peak Gain

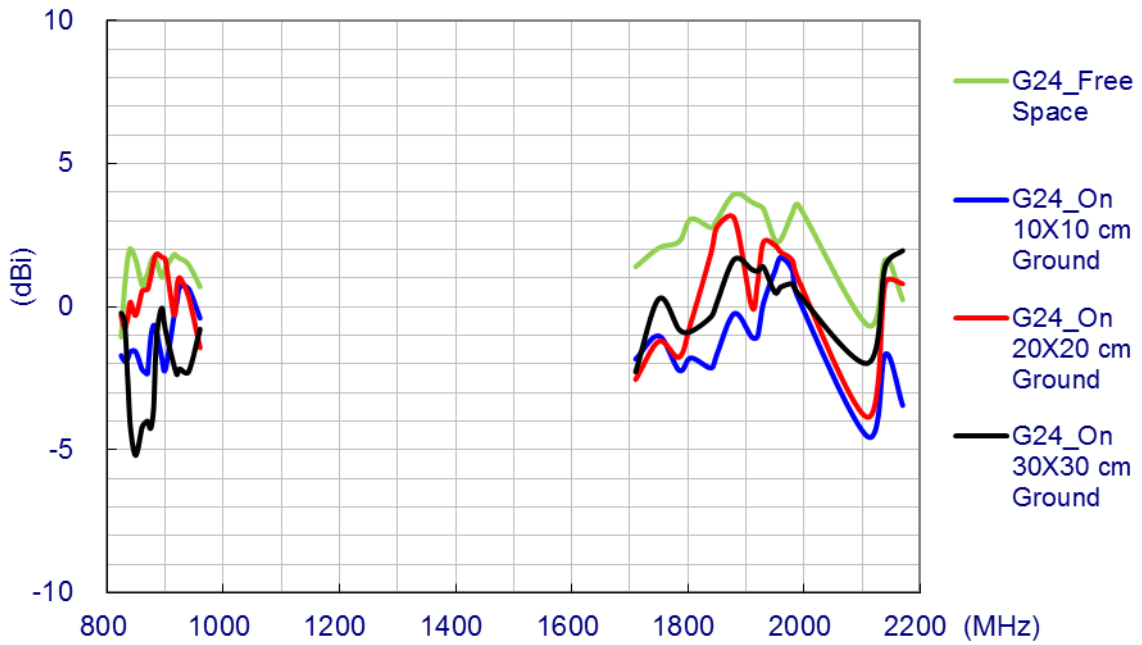

3.4 Average Gain

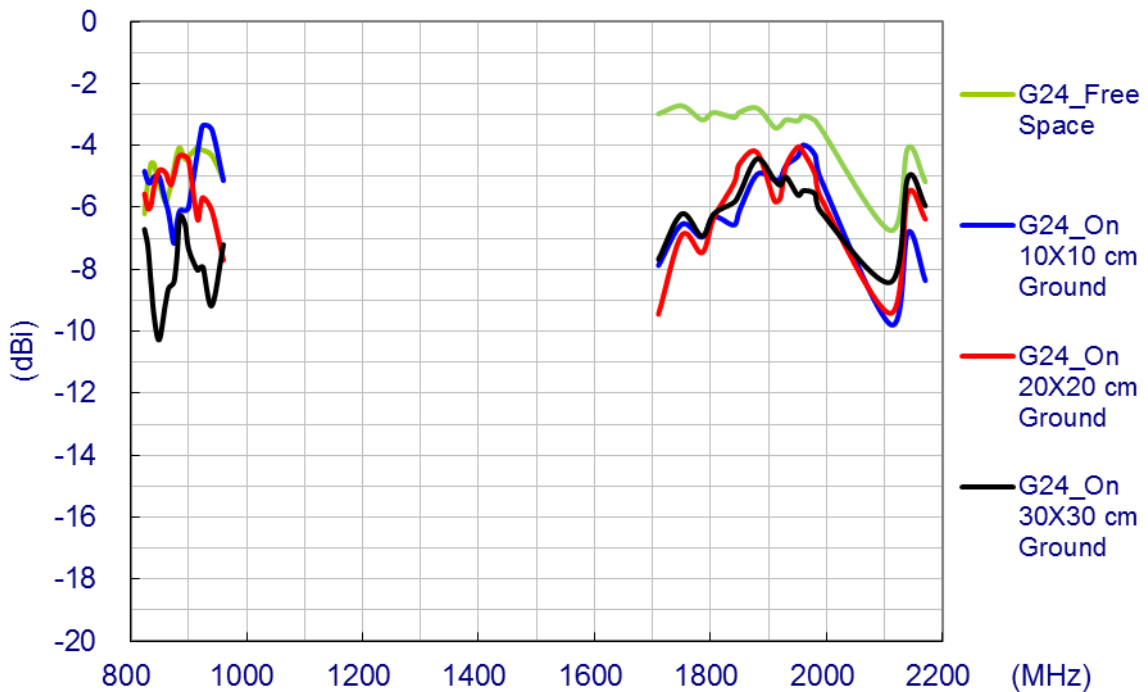

4 Antenna Radiation Pattern (Free Space)

4.1 Antenna Setup (Free Space)



4.2 Radiation Pattern (Free Space)

4.2.1 X-Y plane (dBi) (Free Space)

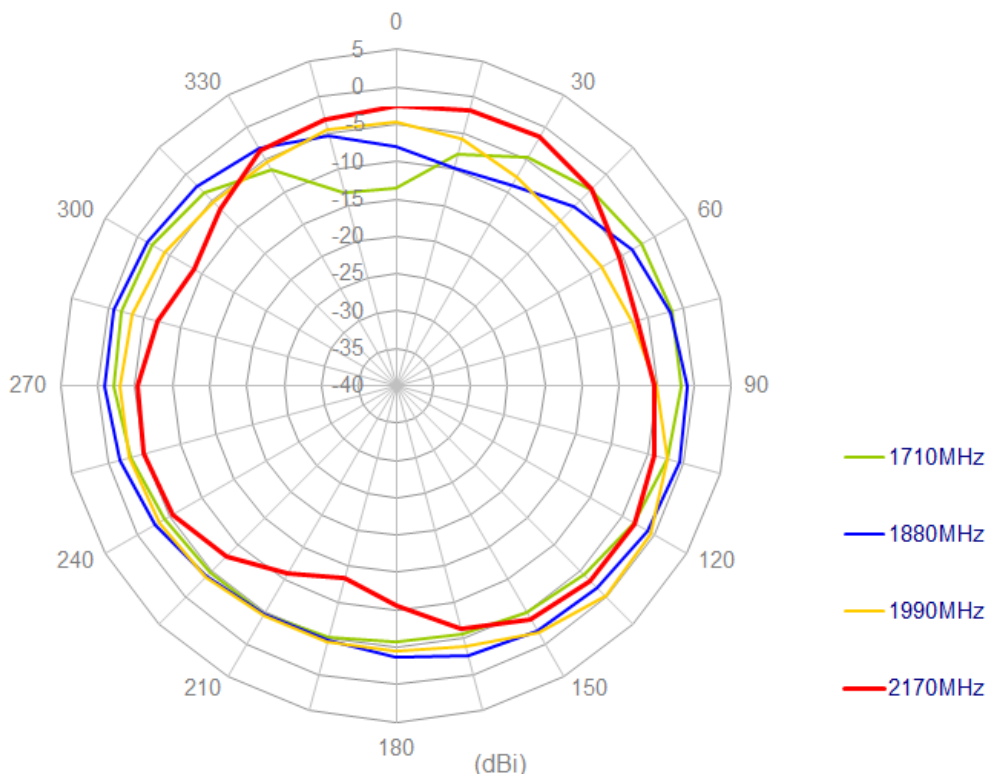
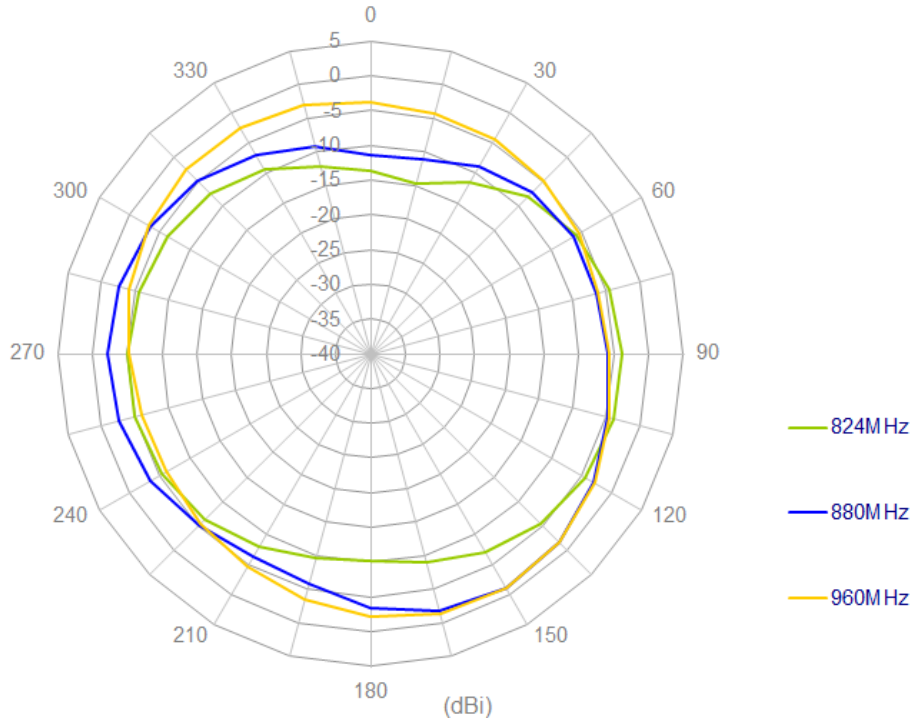

4.2.2 X-Z plane (dBi) (Free Space)

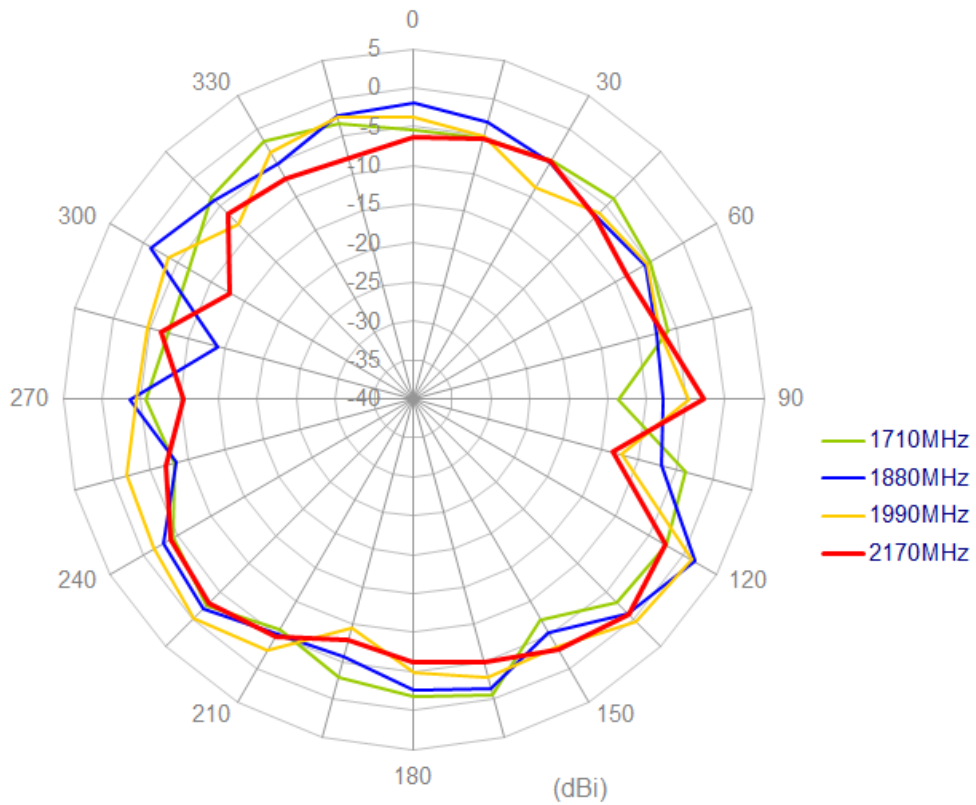
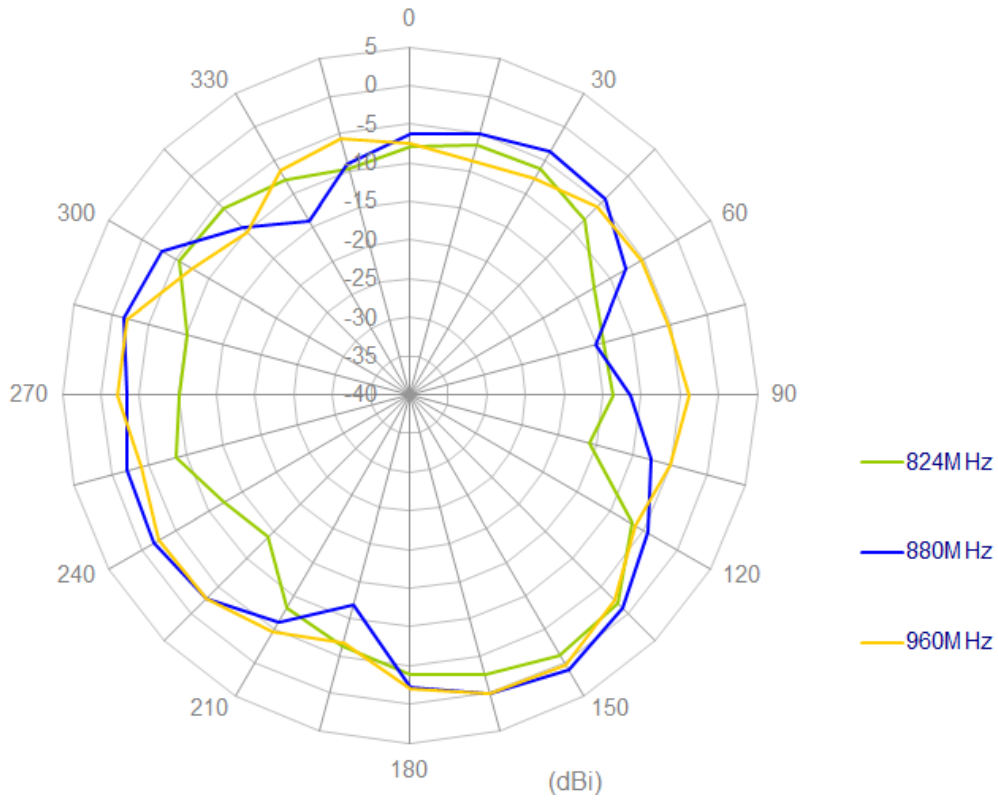

5 Antenna Radiation Pattern (10*10cm)

5.1 Antenna Setup (10*10cm Ground Plane)

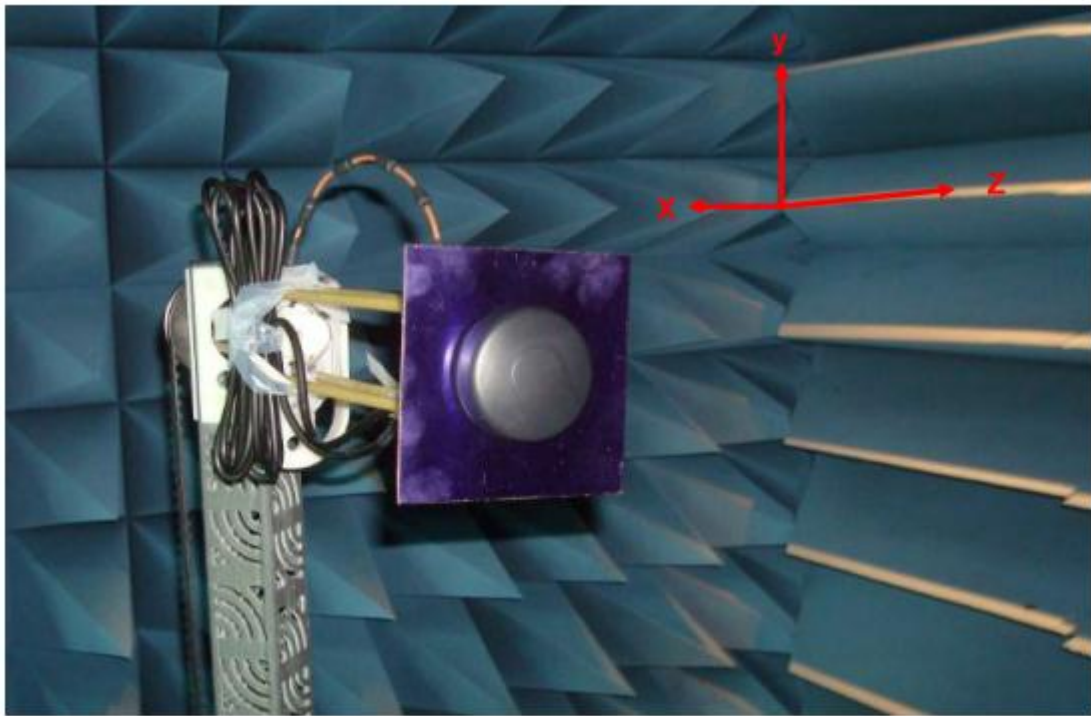



5.2 Radiation Pattern (10*10cm Ground Plane)

5.2.1 X-Y plane (dBi) (10*10cm Ground Plane)

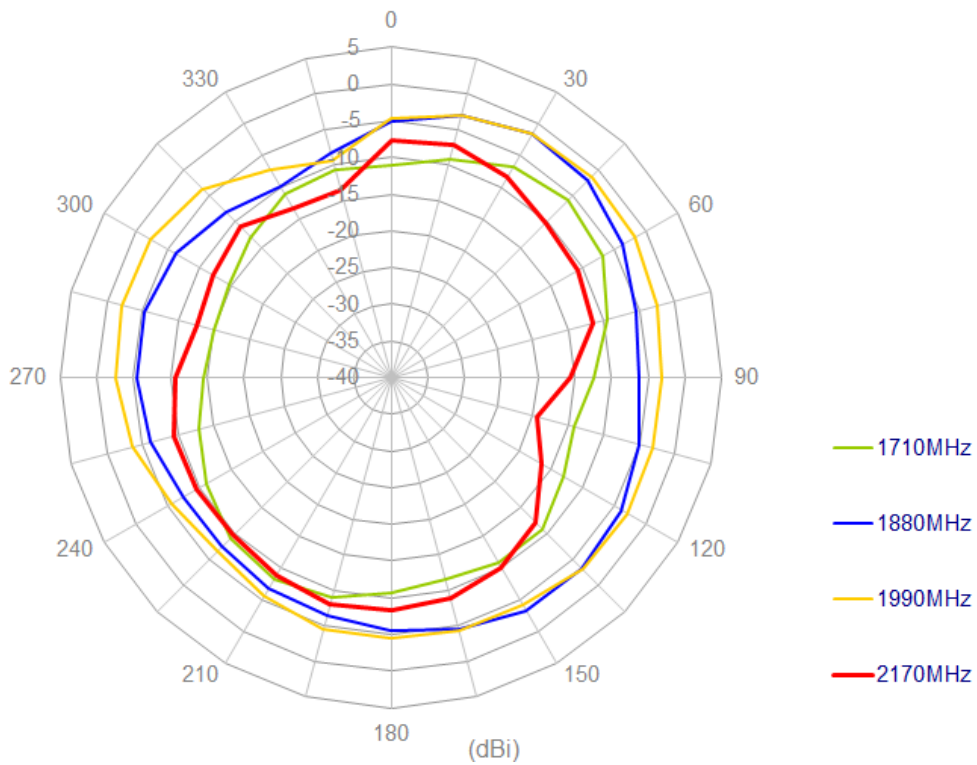
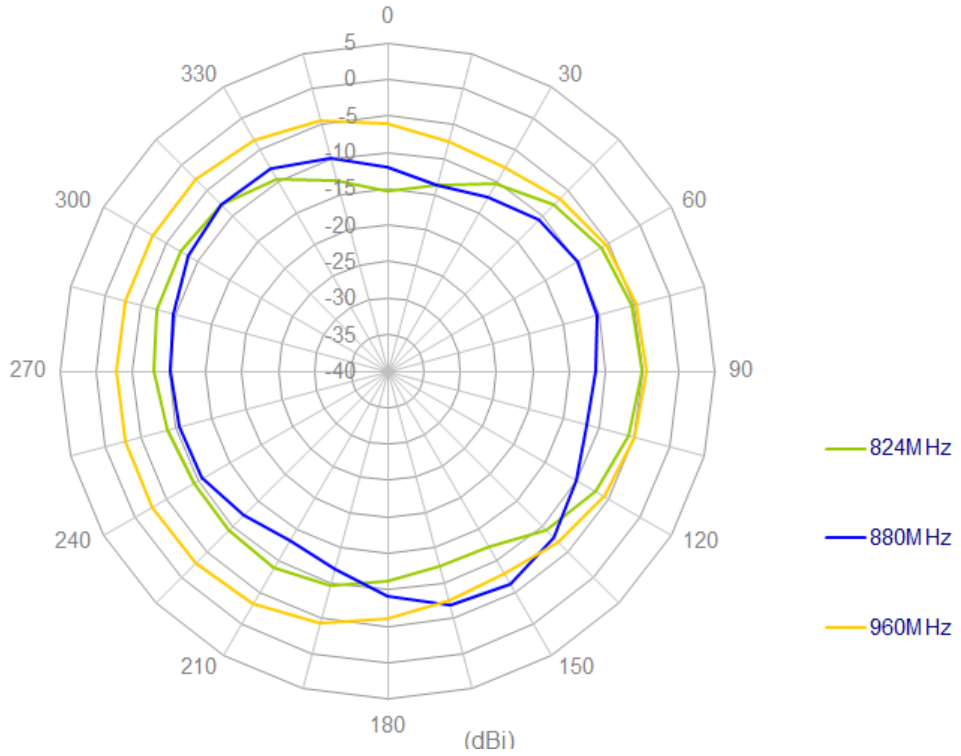

5.2.2 X-Z plane (dBi) (10*10cm Ground Plane)

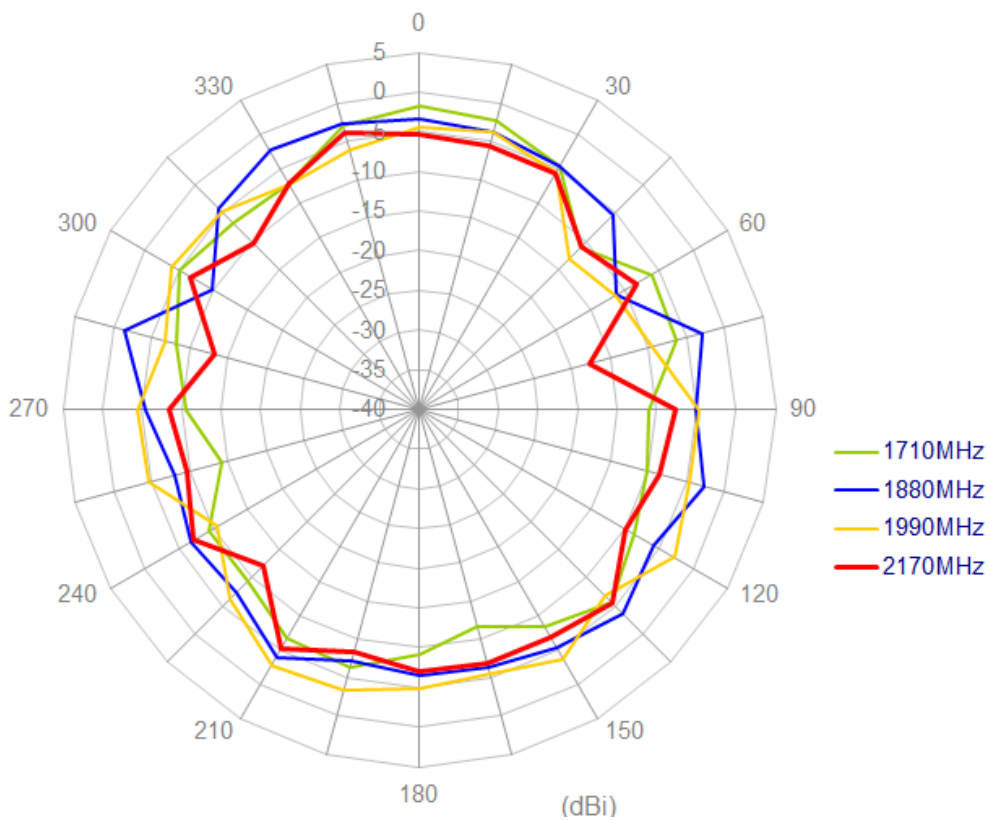
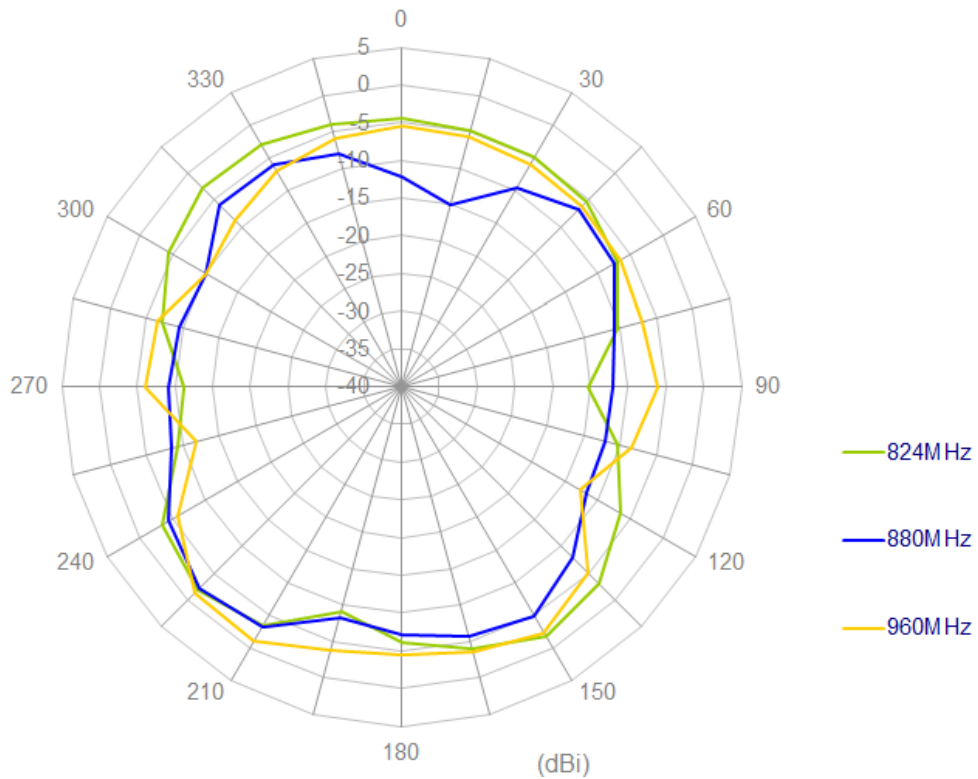



6 Antenna Radiation Pattern (20*20cm Ground Plane)

6.1 Antenna Setup (20*20cm Ground Plane)





6.2 Radiation Pattern (20*20cm Ground Plane)

6.2.1 X-Y plane (dBi) (20*20cm Ground Plane)

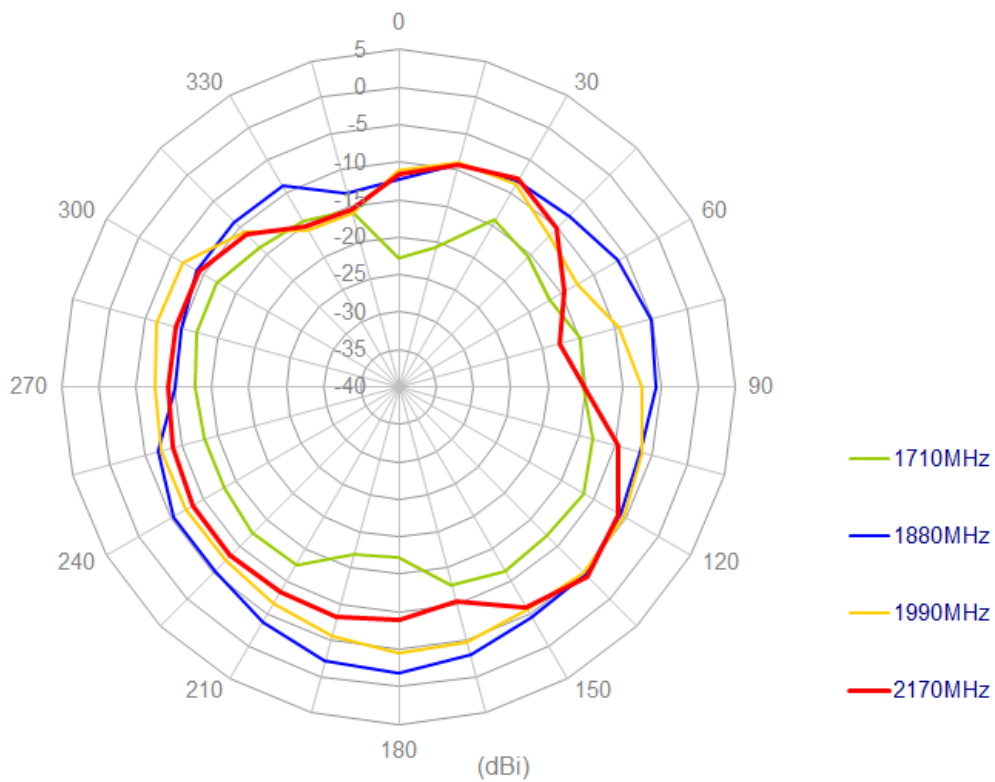
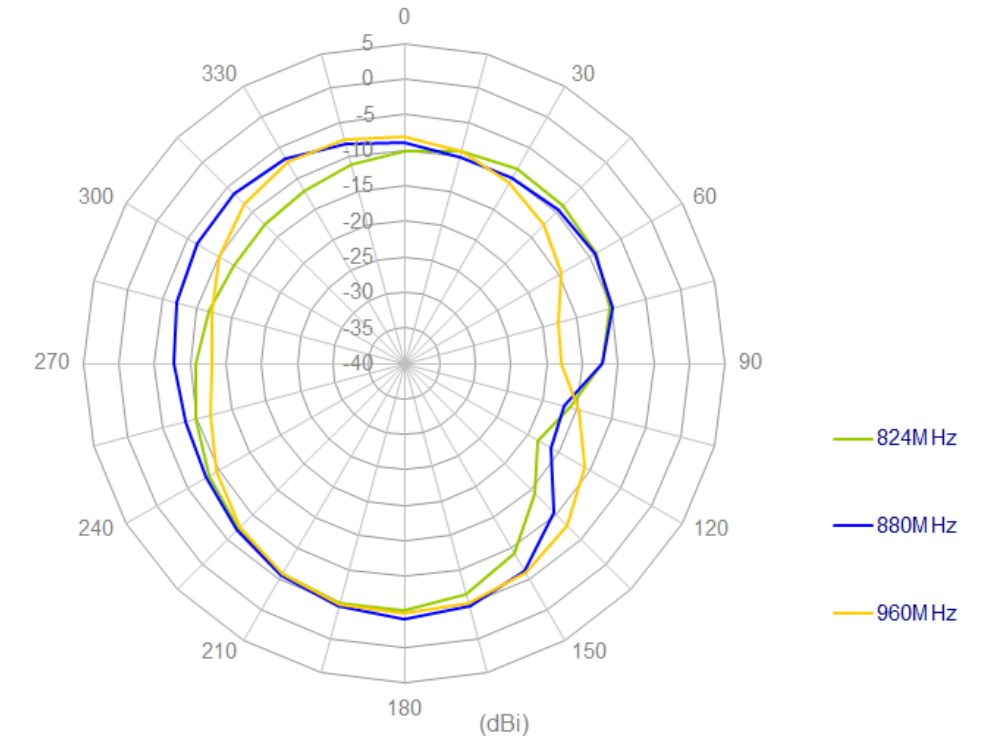



6.2.2 X-Z plane (dBi) (20*20cm Ground Plane)

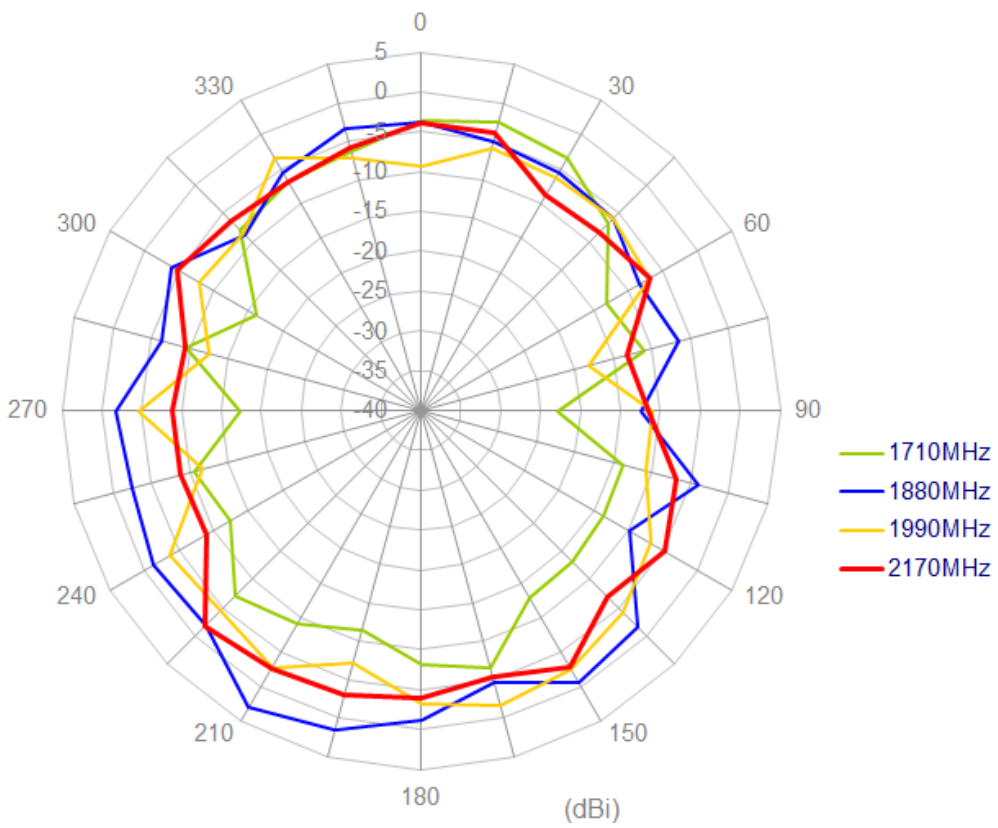
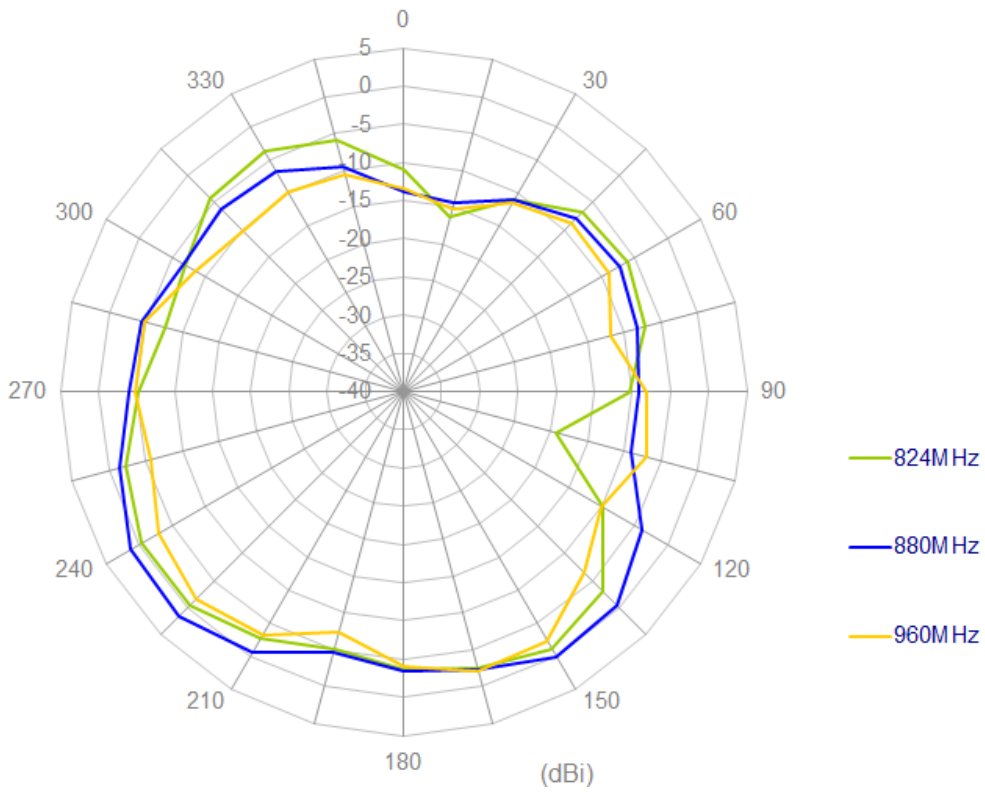

7 Antenna Radiation Pattern (30*30cm Ground Plane)

Ground Plane)

7.1 Antenna Setup (30*30cm Ground Plane)

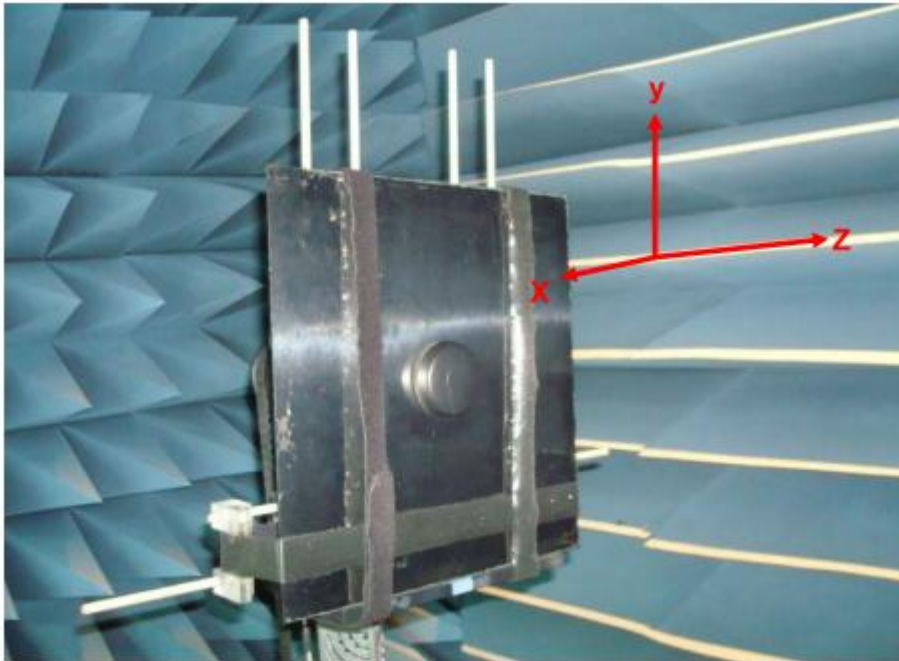



7.2 Radiation Pattern (20*20cm Ground Plane)

7.2.1 X-Y plane (dBi) (20*20cm Ground Plane)

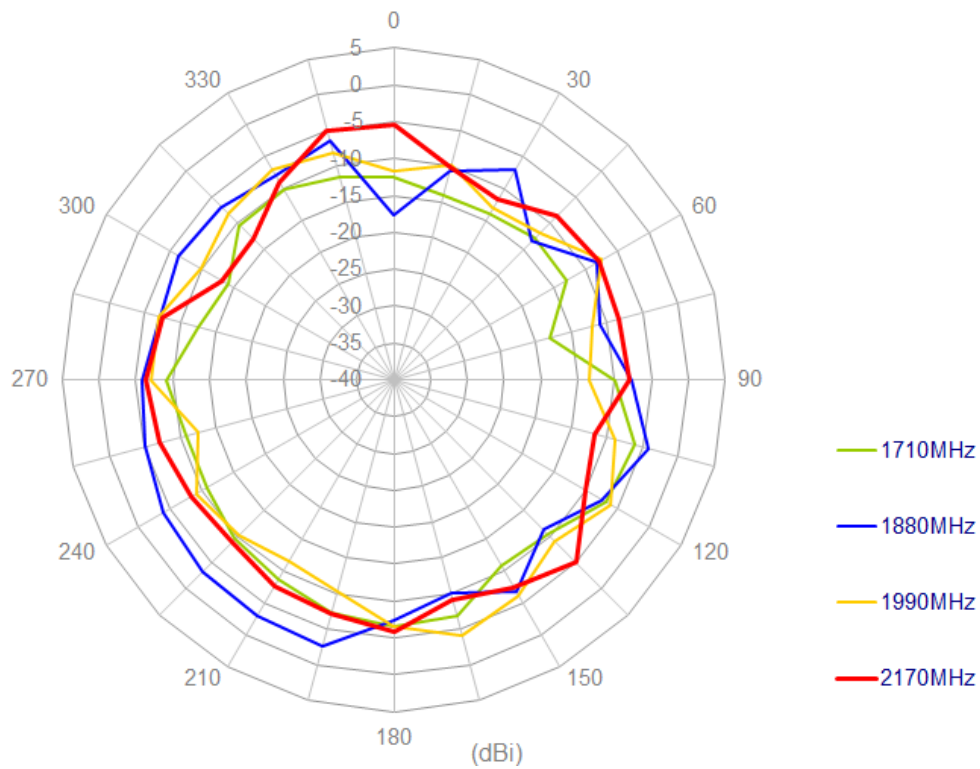
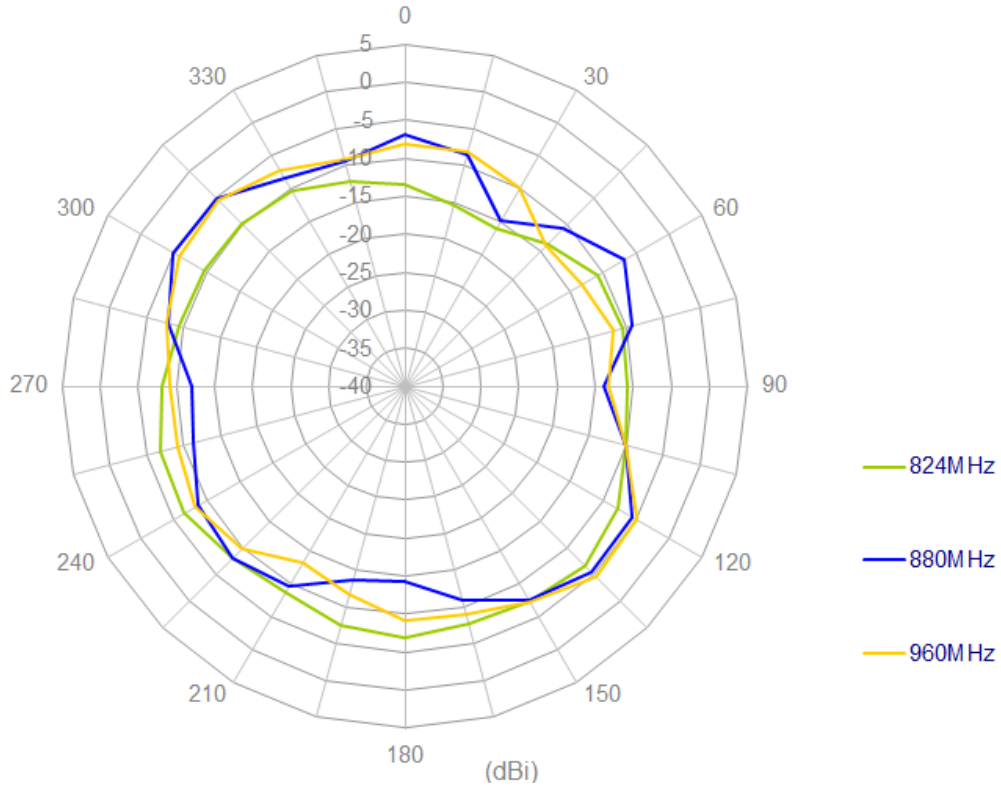



7.2.2 X-Z plane (dBi) (20*20cm Ground Plane)

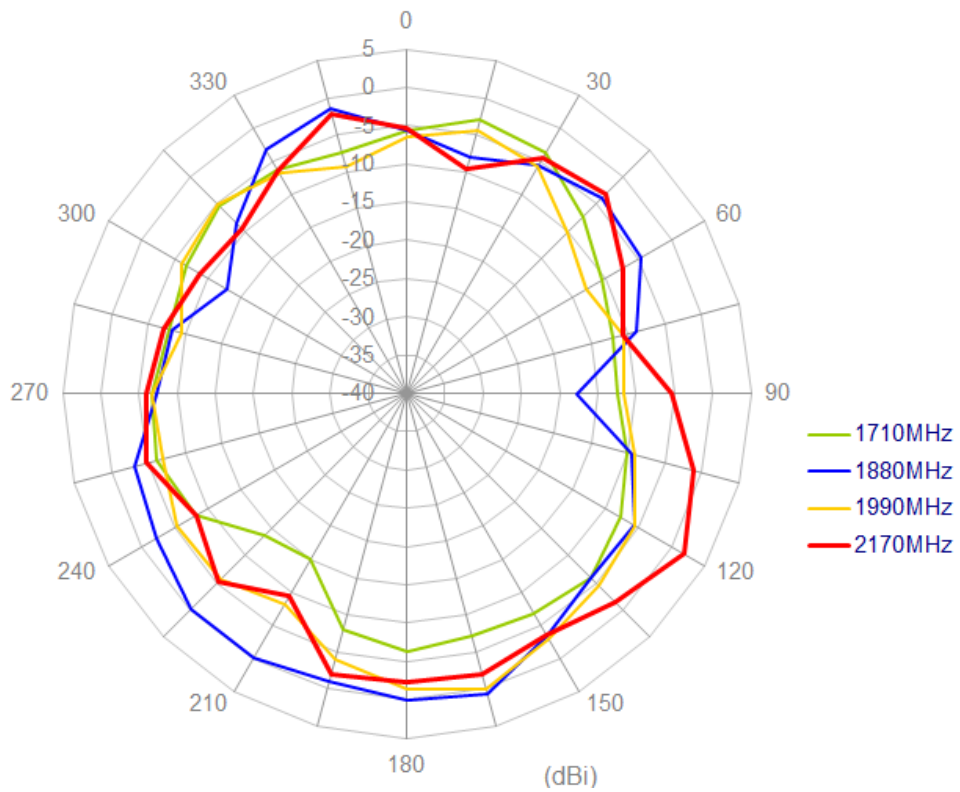
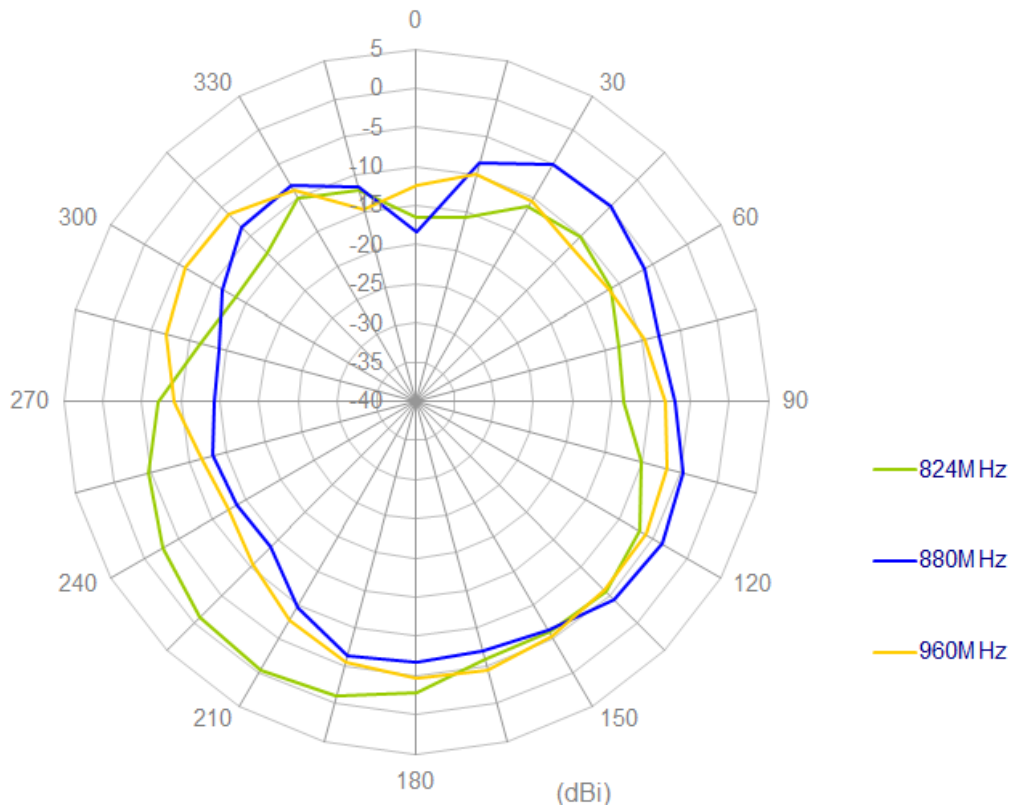



8 Drawing

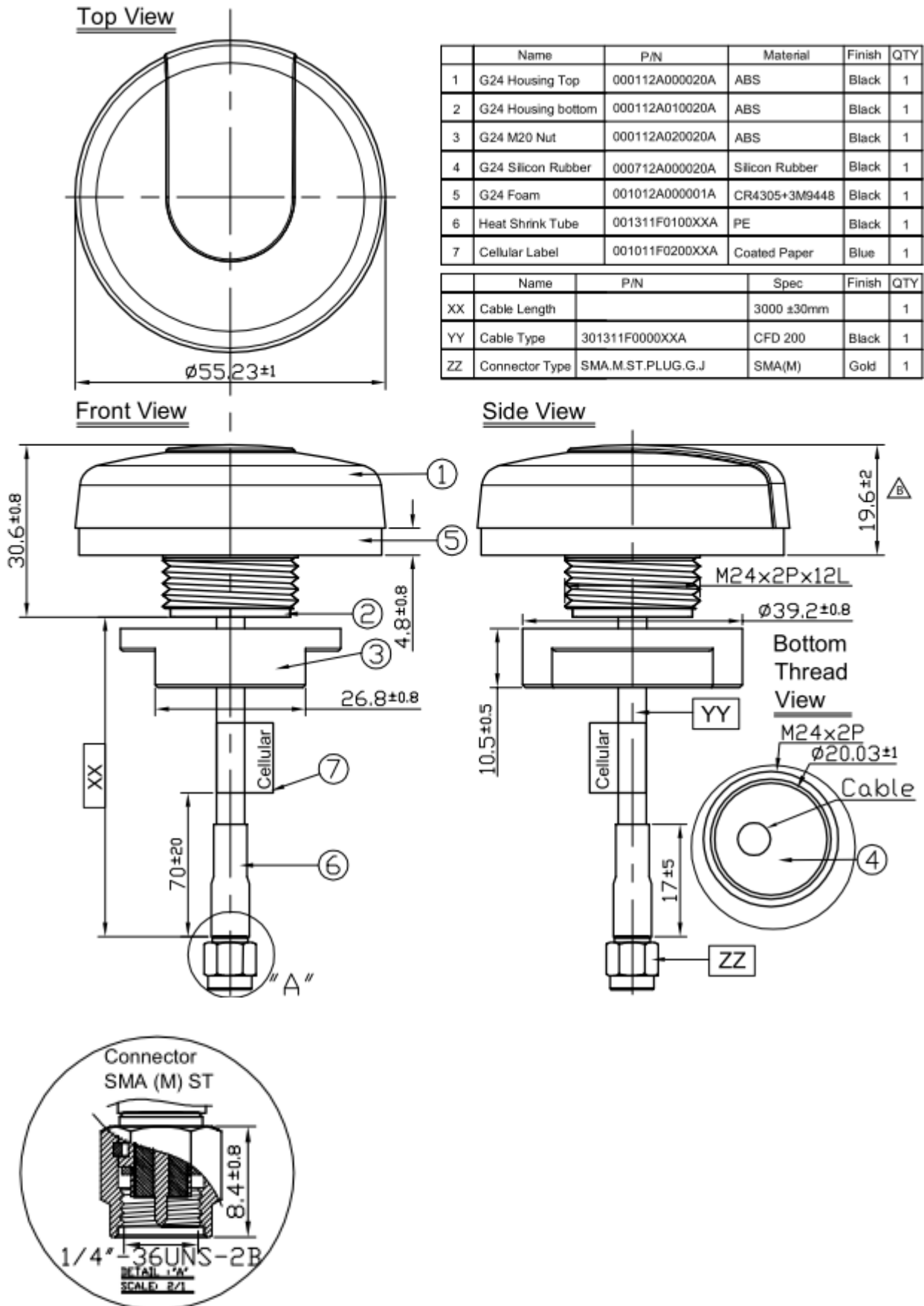

9. Packaging

