

FL

Washable

FUJISOKU SWITCHES

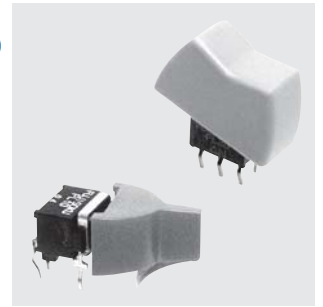

Hyper-miniature Lever & Rocker Switches

RoHS Compliant

Features

1. Hyper-miniature type. The volumetric ratio is half the conventional Series A.
2. Immersion cleaning is possible after soldering.
3. The terminal pitch is of the 0.1-inch size..
4. The independent detent mechanism ensures light operating feeling.
5. For the contact reliability, long-term stability is assured by the clip contacts.
6. Since the contacts are gold-plated, the switches are best suited for use in the dry circuit areas.
7. The full-molded type prevents malfunction caused by static electricity.

Specifications

Rating	Max : 0.4VA (28VDC max.) Min : 1μA 20mVDC
Initial contact resistance	100mΩ max. (1.5mA 200μVAC)
Dielectric strength	250VAC 1 minute
Insulation resistance	500MΩ min. (250VDC)
Electrical life	10,000 cycles at max. rating 50,000 cycles at max. rating (D,E type) 30,000 cycles at max. rating (F,G,H type)
Operating temperature range	-40°C~+85°C
Storage temperature range	-40°C~+85°C

Part Numbering

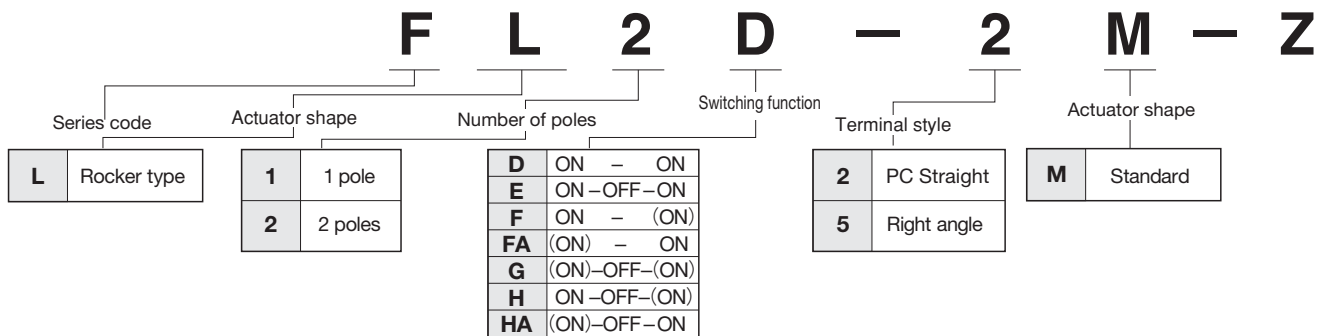

Standard Accessories

《Supplied separately》

Part name	Lever (PC Straight&R/A)	Rocker (PC Straight&R/A)	Rocker (PC Straight)
Dimensions	 ABS resin	 ABS resin	 ABS resin
White	14000050858	140000481410	140000481594
Red	14000050859	140000481411	140000481595
Black	14000050860	140000481412	140000481596
Gray	14000050861	140000481413	140000481597

Lever・Rocker Mounting

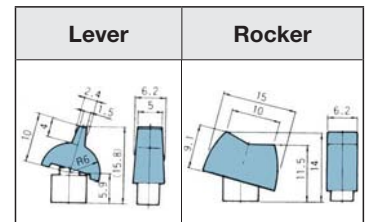

● The lever and the rocker are standard accessories. Specify either of the lever or the rocker by part number.

(ON) : Momentary

FL

SPDT

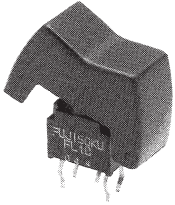

(Mount with Rocker)

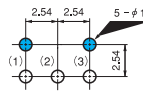
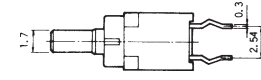
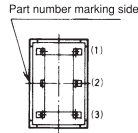
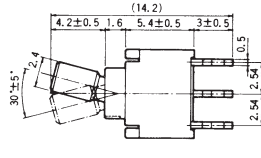
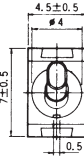

PC Straight

Terminal numbers are not shown on the bottom of the switch.

PC Hole Layouts

Switching function Part No.	Viewed from part No. marking side		
FL1D-2M-Z	ON	—	ON
▲FL1E-2M-Z	ON	OFF	ON
▲FL1F-2M-Z	(ON)	—	ON
★FL1G-2M-Z	(ON)	OFF	(ON)
▲FL1H-2M-Z	(ON)	OFF	ON
Connecting terminals	2-1	—	2-3

DPDT



(Mount with Rocker)

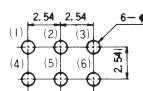
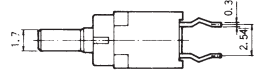
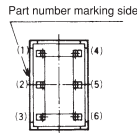
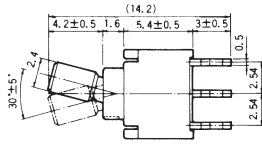
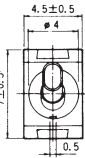

PC Straight

Terminal numbers are not shown on the bottom of the switch.

PC Hole Layouts

Switching function Part No.	Viewed from part No. marking side		
★FL2D-2M-Z	ON	—	ON
▲FL2E-2M-Z	ON	OFF	ON
★FL2F-2M-Z	(ON)	—	ON
★FL2G-2M-Z	(ON)	OFF	(ON)
▲FL2H-2M-Z	(ON)	OFF	ON
Connecting terminals	2-1 5-4	—	2-3 5-6

SPDT



(Mount with Rocker)

R/A

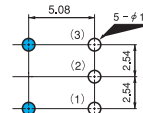
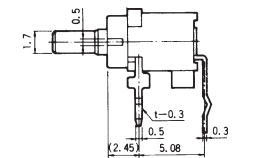
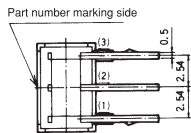
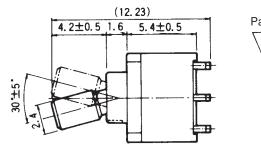
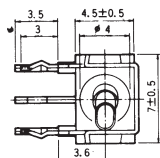

Terminal numbers are not shown on the bottom of the switch.

PC Hole Layouts

Switching function Part No.	Viewed from part No. marking side		
★FL1D-5M-Z	ON	—	ON
▲FL1E-5M-Z	ON	OFF	ON
▲FL1F-5M-Z	ON	—	(ON)
▲FL1FA-5M-Z	(ON)	—	ON
★FL1G-5M-Z	(ON)	OFF	(ON)
▲FL1H-5M-Z	ON	OFF	(ON)
▲FL1HA-5M-Z	(ON)	OFF	ON
Connecting terminals	2-3	—	2-1

DPDT

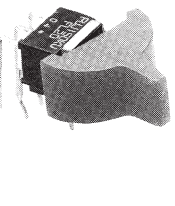

(Mount with Rocker)

R/A

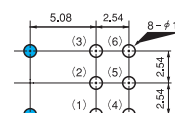
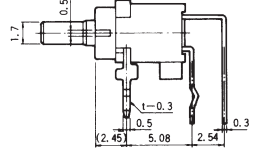
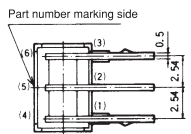
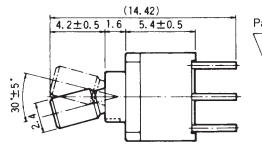
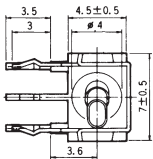

Terminal numbers are not shown on the bottom of the switch.

PC Hole Layouts

Switching function Part No.	Viewed from part No. marking side		
★FL2D-5M-Z	ON	—	ON
▲FL2E-5M-Z	ON	OFF	ON
▲FL2F-5M-Z	ON	—	(ON)
▲FL2FA-5M-Z	(ON)	—	ON
▲FL2G-5M-Z	(ON)	OFF	(ON)
▲FL2H-5M-Z	ON	OFF	(ON)
▲FL2HA-5M-Z	(ON)	OFF	ON
Connecting terminals	2-3 5-6	—	2-1 5-4

■ Packaging Specifications

Plastic Pack

100 pcs/pack

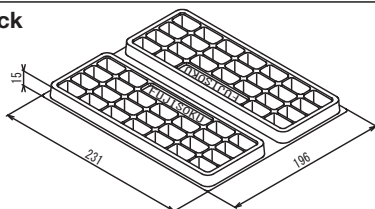

■ Soldering Specifications

(1) Manual Soldering

Device: Soldering iron
380°C, Max.; 3 seconds, Max.

(2) Auto Soldering

Device: Jet wave type or dip type
275°C; 6 seconds, Max.

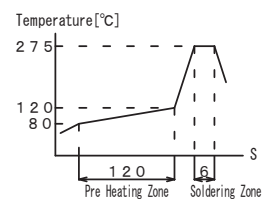

★ : Made to order products.