

Cellular and Positioning Shield User's Guide

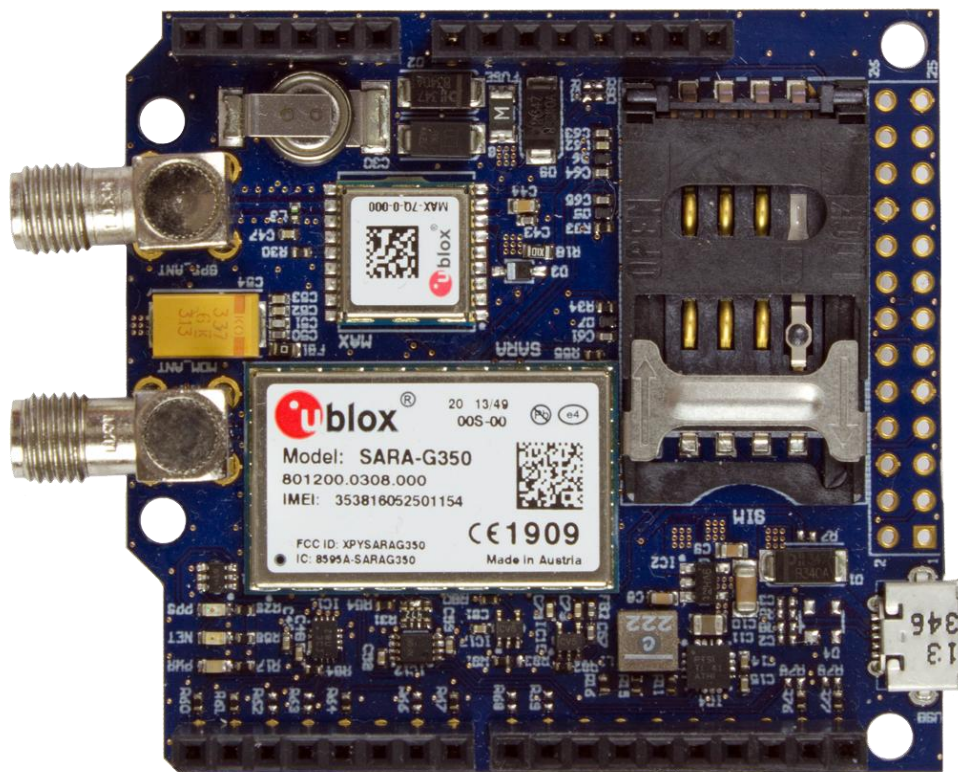

*Get Up-and-Running Quickly and
Start Developing Your Application On Day 1!*

Embedded Artists AB

Davidshallsgatan 16
211 45 Malmö
Sweden

info@EmbeddedArtists.com
<http://www.EmbeddedArtists.com>

Copyright 2014 © Embedded Artists AB. All rights reserved.

No part of this publication may be reproduced, transmitted, transcribed, stored in a retrieval system, or translated into any language or computer language, in any form or by any means, electronic, mechanical, magnetic, optical, chemical, manual or otherwise, without the prior written permission of Embedded Artists AB.

Disclaimer

Embedded Artists AB makes no representation or warranties with respect to the contents hereof and specifically disclaim any implied warranties or merchantability or fitness for any particular purpose. Information in this publication is subject to change without notice and does not represent a commitment on the part of Embedded Artists AB.

Feedback

We appreciate any feedback you may have for improvements on this document. Please send your comments to support@EmbeddedArtists.com.

Trademarks

All brand and product names mentioned herein are trademarks, services marks, registered trademarks, or registered service marks of their respective owners and should be treated as such.

Table of Contents

1	Document Revision History	4
2	Declaration of Conformity	5
3	Introduction	6
3.1	Features	6
3.2	ESD Precaution	6
3.3	General Handling Care	7
3.4	Other Products from Embedded Artists	7
3.4.1	Design and Production Services	7
3.4.2	OEM / LPCXpresso / QuickStart Boards and Kits	7
4	Getting Started	8
4.1	Preparations	8
4.2	m-center Application	9
4.2.1	Direct USB connection on 3G version	12
4.3	UART Pass-Through Applications	12
5	Cellular and Positioning Shield Design	13
5.1	Cellular Modem	13
5.2	GNSS/GPS Receiver	14
5.3	Power Supply	14
5.4	Level Shifters	14
5.5	Arduino™ Shield Connector	14
5.6	Raspberry Pi Connector	16
5.7	USB Connector	16
5.8	LED	16
5.9	Locating Components	16
6	Things to Note	18
6.1	SIM Card not Found	18
7	Further Information	19

1 Document Revision History

<i>Revision</i>	<i>Date</i>	<i>Description</i>
PA1	2014-11-04	First version.

2 Declaration of Conformity



We, **Embedded Artists AB, Davidshallsgatan 16, 21145 Malmö, Sweden**, declare under our sole responsibility that our products:

- Cellular and Positioning Shield - GSM/GPRS (2.5G), model: EAA00202
- Cellular and Positioning Shield - UMTS (3G), model: EAA00215

to which this declaration relates, conforms to the following Product Specifications:

Health and Safety Standards: **EN 60950-1:2006+A11:2009+A1:2010+A12:2011+AC:2011**
(R&TTE article 3.1a) **EN 62311:2008**

EMC Standards: **EN 301 489-24 V1.5.1**
(R&TTE article 3.1b) **EN 301 489-7 V1.3.1**
EN 301 489-1 V1.9.2
EN 61000-6-3:2007

Radio Spectrum Efficiency Standard: **EN 301 511 V9.0.2**
(R&TTE article. 3.2) **EN 301 908-2 V6.2.1**
EN 301 908-1 V6.2.1

RoHS: **EN 50581:2012**

Concerning article 3.3 of the R&TTE directive, no additional requirements have been considered as relevant for this class of apparatus.

Supplementary Information:

The products herewith complies with the requirements of the Low Voltage Directive 2006/95/EC, the EMC Directive 2004/108/EC, the R&TTE Directive 1999/5/EC, the RoHS Directive 2011/65/EU and carries the CE-marking accordingly.

Anders Rosvall, Technical Director of Embedded Artists AB

Malmö, November 4, 2014

3 Introduction

Thank you for buying Embedded Artists' *Cellular and Positioning Shield*. The shield/board has been designed for **IoT applications**. It builds around high-quality cellular and positioning modules from ublox and has been designed in cooperation with them.

There are two versions of the shield; one 2.5G (GSM/GPRS) and 3G (UMTS) version. This document is a User's Guide that describes the hardware design for both versions. The document use the *LPC4088 Experiment Bundle* as example platform to describe how the shields operate. The shields have a general design and can operate together with many different platforms.

3.1 Features

Embedded Artists' *Cellular and Positioning Shield* lets you get up-and-running quickly with IoT applications. The features of the shield/board are:

- SARA-G350-0xS GSM/GPRS module on 2.5G shield version, or
 - Quad-band version for global connectivity
- SARA-U270-0xS UMTS module on 3G shield version
 - **Note:** UMTS/HSPA frequency bands are 900/2100 MHz and GSM/EDGE frequency bands are 900/1800 MHz, which are **commonly used in Europe/Africa/Asia, but not in North America**.
- MAX-7Q-0 GPS/GNSS module on 2.5G shield version, or
- MAX-M8Q-0 GPS/GNSS module on 3G shield version
- SMA connectors for both modules (right-angled female)
- SIM card connector (note: SIM card not included)
- Arduino™ shield and Raspberry Pi (RPi) compatible connectors for external interface
 - UART interface to cellular module
 - I2C interface to positioning module
 - POWER_ON and GPS_EXTINT GPIO signals
 - Note that RPi pin header is not soldered - just pads on pcb
- On-board power supply
 - Requires external 5-12V DC / 1Amp power supply
 - Input power via micro-B USB connector, Arduino shield connectors or RPi expansion connector
- Dimensions
 - Compact size: 54 x 66 mm (including SMA connectors)
 - Note that antenna connectors will build to the 66mm measure.

3.2 ESD Precaution

Please note that the *Cellular and Positioning Shield* come without a case/box and all components are exposed for finger touches – and therefore extra attention must be paid to ESD (electrostatic discharge) precaution.



Make it a habit always to first touch the metal surface of one of the SMA connectors for a few seconds with both hands before touching any other parts of the boards. That way, you will have the same potential as the board and therefore minimize the risk for ESD.

In general touch as little as possible on the boards in order to minimize the risk of ESD damage.

Note that Embedded Artists does not replace boards that have been damaged by ESD.

3.3 General Handling Care

Handle the *Cellular and Positioning Shield* with care. The board is not mounted in a protective case/box and is not designed for rough physical handling. Connectors can wear out after excessive use. The *Cellular and Positioning Shield* is designed for prototyping use, and not for integration into an end-product.

Note that Embedded Artists does not replace boards what have been improperly handled.

3.4 Other Products from Embedded Artists

Embedded Artists have a broad range of LPC based boards that are very low cost and developed for prototyping / development as well as for OEM applications (i.e., for integration). Modifications for OEM applications can be done easily, even for modest production volumes. Contact Embedded Artists for further information about design and production services.

3.4.1 Design and Production Services

Embedded Artists provide design services for custom designs, either completely new or modification to existing boards. Specific peripherals and I/O can be added easily to different designs, for example, communication interfaces, specific analog or digital I/O, and power supplies. Embedded Artists has a broad, and long, experience in designing industrial electronics in general and with NXP's LPC microcontroller families in specific. Our competence also includes wireless and wired communication for embedded systems.

3.4.2 OEM / LPCXpresso / QuickStart Boards and Kits

Visit Embedded Artists' home page, www.EmbeddedArtists.com, for information about other products or contact your local distributor.

4 Getting Started

This chapter contains information about how to get acquainted with the *Cellular and Positioning Shield*. **Please read this section first before you start using the board - it will be well spent time!**

4.1 Preparations

This section walks through the preparations that must be done to get the system (i.e., Cellular and Positioning shield) up and running.

First, acquire a standard size SIM card (sometimes also called "mini SIM") and mount it in the SIM card holder. Make sure the it supports data communication. The picture below illustrates how to mount the SIM card.

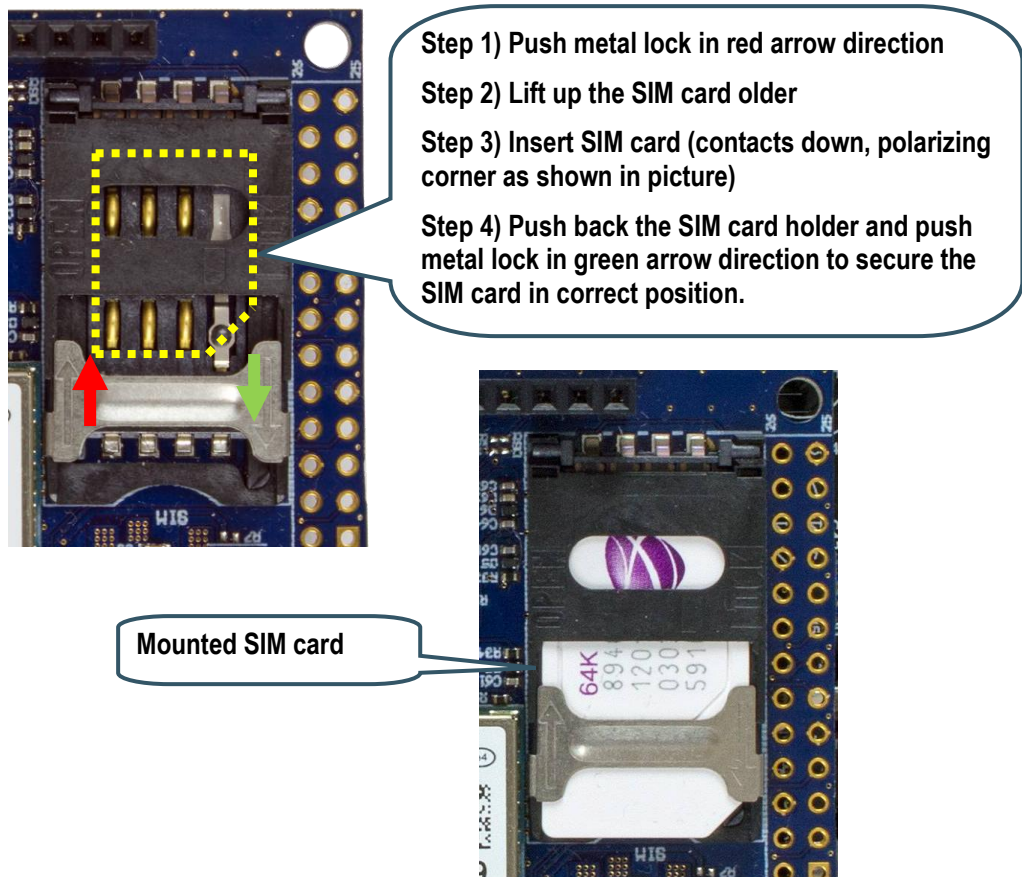

Figure 1 – Mounting SIM Card

Next, connect the shield to a system. It can be via the Arduino, Raspberry Pi connectors or, in the case of the 3G version, a direct USB connection to a PC. As an illustrated example, the picture below shows the shield mounted on the *LPC4088 Experiment Bundle*.

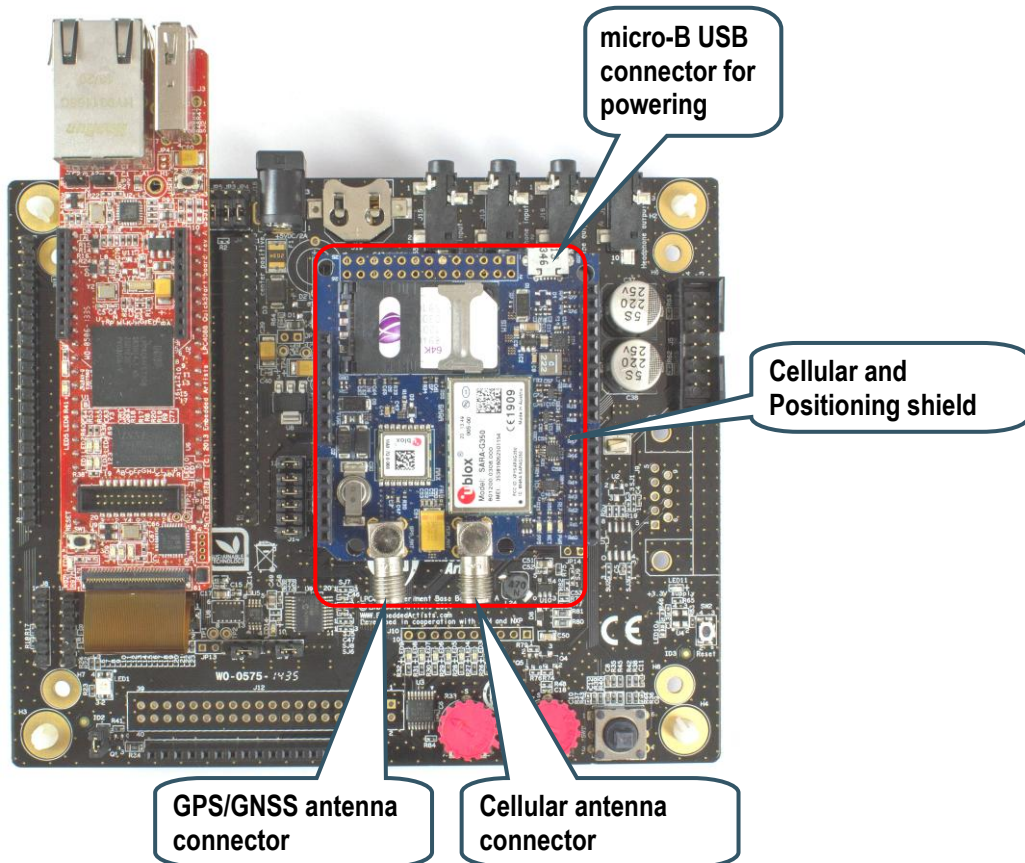

Figure 2 –Shield Mounted on LPC4088 Experiment Bundle

The next step is to mount the antennas. Only use the antennas that are shipped with the shield. The picture above also shows where the GPS/GNSS and cellular antennas shall be mounted. The GPS/GNSS antenna has a big puck/box at the very end and a long antenna cable. The cellular antenna is short and connects directly to the SMA connector.

The final step is to provide an external power source to the shield. A 5-12V DC / 1Amp supply is suitable. Three options exist:

- Power the shield via the micro-B USB connector. This will by default be a 5V supply, for example a USB charger.
- Power the shield via the Arduino connectors; either the +5V power supply or the VIN (12V max) power supply can power the shield, whichever has highest voltage.
- Power the shield via the Raspberry Pi connector; pin 2, 4 are +5V input and pin 6, 9, 14, 20, 25 are ground.

4.2 m-center Application

u-box has created a (Windows) PC application for direct evaluation, configuration and testing of the cellular modem. The application is called **m-center**. The PC application communicates with the cellular modem via the UART channel. The application can be downloaded from here: <http://www.u->

blox.com/en/evaluation-tools-a-software/u-center/m-center.html and there is also an associated user's manual for the application. This section will just describe how to get the initial connection. The rest of the details can be found in the m-center manual.

Embedded Artists has created a 'UART pass-through' application on the *LPC4088 QuickStart Board*. It can be downloaded from the *LPC4088 Experiment Base Board* project page:

<https://developer.mbed.org/users/embeddedartists/notebook/lpc4088-experiment-base-board---projects/>

When the m-center application has started the main window looks like below. Start with selecting the virtual COM port to connect to. In this case, the virtual OCM port that the HDK on the *LPC4088 QuickStart board* creates.

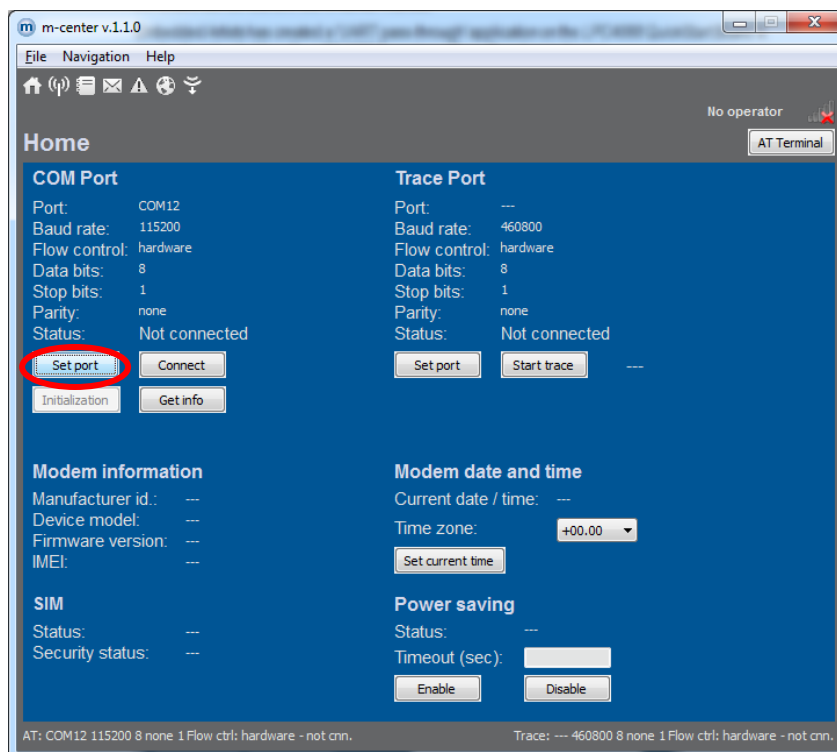

Figure 3 – m-center Main Window

Select the HDK COM port and set 115200 bps, 8N1, no flow control.

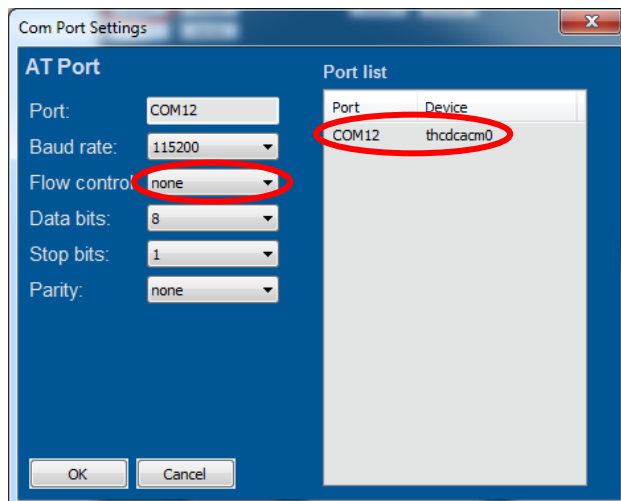

Figure 4 – m-center Set COM Port

Next, press the *Connect*-button and then the *Initialization*-button. The cellular modem information will be displayed in the lower left corner.

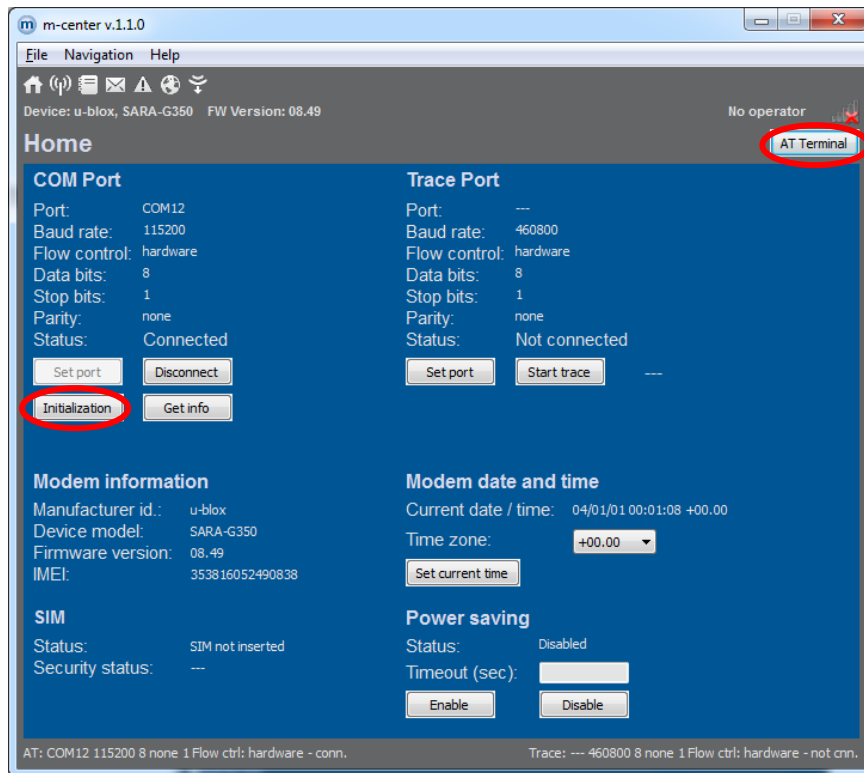

Figure 5 – m-center Main Window, Modem Connected

In the upper right corner it is possible to click on *AT Terminal*-button to open a terminal window where direct AT commands can be sent. Consult the cellular modem AT command manual for details.

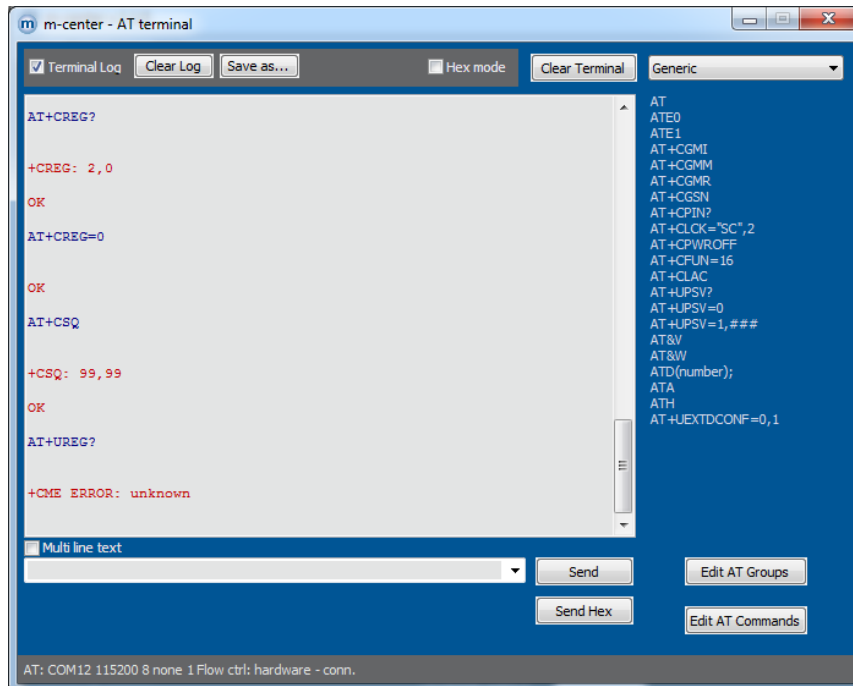

Figure 6 – m-center, AT Terminal

4.2.1 Direct USB connection on 3G version

The 3G version of the cellular modem has direct USB support, so connecting the a PC to the micro-B USB connector on the shield will give a direct access (via virtual COM ports) to the cellular modem. No 'UART pass-through' application is needed (and no base board either).

4.3 UART Pass-Through Applications

Embedded Artists has created a 'UART pass-through' application on the *LPC4088 QuickStart Board*. It can be downloaded from the *LPC4088 Experiment Base Board* project page:

<https://developer.mbed.org/users/embeddedartists/notebook/lpc4088-experiment-base-board---projects/>

The application can be used to allow the m-center PC application to communication with the cellular modem via the mbed HDK virtual COM port.

5 Cellular and Positioning Shield Design

This chapter contains information about the hardware design of the *Cellular and Positioning Shield* and the different options on the board. The schematic can be downloaded in pdf format from the product page, and is recommended to have printed out while reading this chapter.

The picture below gives an overview of the *Cellular and Positioning Shield* design.

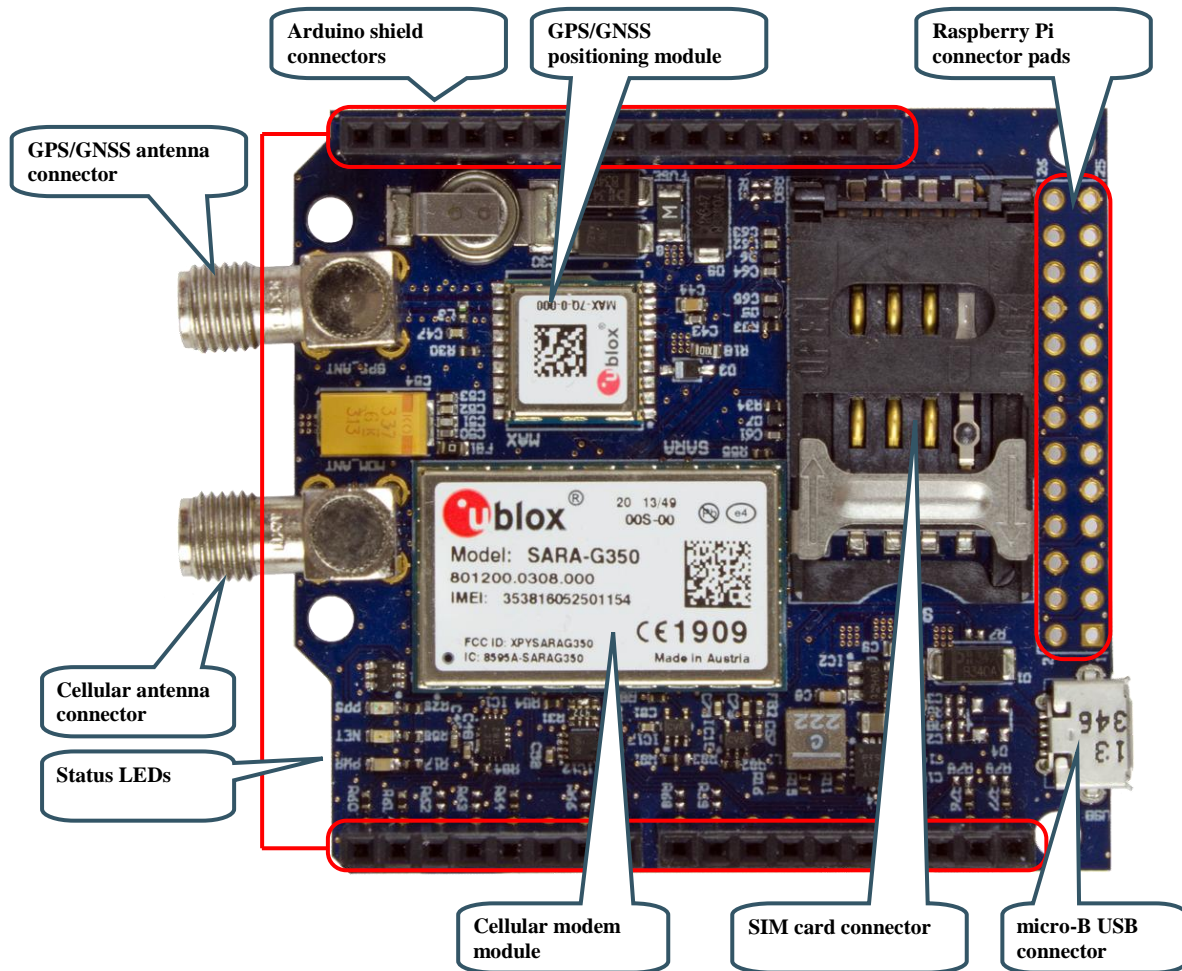

Figure 7 – Cellular and Positioning Shield Overview

5.1 Cellular Modem

The cellular modem from u-blox is one of two versions (SARA-G350 or SARA-U270, depending on shield version). The modules are pin compatible. A SIM card connector with ESD protection and antenna connector (SMA) are connected to the modem.

The cellular module is accessed via the UART interface per default design of the shield. Only RXD and TXD are connected but by mounting configuration resistors R62/R63 RTS and CTS signals can be added to the interface.

Signal MDM_PWR_ON controls the PWR_ON signal on the cellular modem.

Normally the UART channel of the modem is used to communicate with it. The SARA-U270 modem also has a USB channel, as an alternative communication channel.

5.2 GNSS/GPS Receiver

The position module from u-blox is one of two versions (MAX-7Q or MAX-M8Q, depending on shield version). The modules are pin compatible. An antenna connector (SMA) is connected to the module. A 0.22F super capacitor can power the positioning module for some time to keep time.

The position module is accessed via the I2C interface per default design of the shield. There is configuration resistors that are not mounted that allows for UART access (by mounting R68/R69) or letting the cellular modem communicate with the module (mount R78/R79). U-blox cellular modems has a positioning tunneling mode for simpler access of both a cellular and positioning module via just one serial interface.

The positioning module directly controls one LED for the once-a-second pulse. The signal can be made accessible via a configuration resistor (mount R66).

5.3 Power Supply

The power supply on the board is straight forward and simple, yet flexible. An external supply (5-14V DC / 1Amp min) is converted to 3.8V for the cellular modem. A switched DC/DC converter is used, switching at 2.5 MHz. The external power supply comes from:

- +5V on Arduino or Raspberry Pi connectors, or
- VIN pin on Arduino connector, or
- micro-B USB connector

An LDO created a 3.3V (from the 3.8V supply) to power the positioning module.

5.4 Level Shifters

The level shifters translate between the 3.3V I/O voltage of the shield and the cellular modem I/O voltage (1.8V).

5.5 Arduino™ Shield Connector

There are four male/female connectors around the board edge that together form an Arduino UNO R3 compatible shield connector.

Arduino Signals	RPi Signals	Usage	Note
SCL	Pin 5, SCL/GPIO1	I2C communication with positioning module	Input to shield.
SDA	Pin 3, SDA/GPIO0	I2C communication with positioning module	Bidirectional signal.
D13: GPIO/SPI-SCK	Not connected	Not connected	
D12: GPIO/SPI-MISO	Not connected	Not connected	
D11: GPIO/PWM/SPI-MOSI	Not connected	Not connected	
D10: GPIO/PWM/SPI-SSEL	Not connected	Not connected	
D9: GPIO/PWM	Not connected	Normally not connected	Connected to positioning module RXD if configuration resistor

			R69 is mounted. Input to shield.
D8: GPIO	Not connected	Normally not connected	Connected to positioning module TXD if configuration resistor R68 is mounted. Output from shield.
D7: GPIO	Pin 13, GPIO21	Connected to positioning module, signal: GPS_EXTINT	Input to shield.
D6: GPIO/PWM	Pin 15, GPIO22, normally not connected	Normally not connected	Connected to positioning module, signal: GPS_PPS (one-a-second pulse signal). Output from shield.
D5: GPIO/PWM	Not connected	Not connected	
D4: GPIO	Pin 16, GPIO23	Connected to cellular module PWR_ON	
D3: GPIO/PWM	Pin 12, GPIO18, normally not connected	Normally not connected	Connected to cellular module CTS if configuration resistor R63 is mounted. Output from shield.
D2: GPIO	Pin 11, GPIO17, normally not connected	Normally not connected	Connected to cellular module RTS if configuration resistor R62 is mounted. Input to shield.
D1: GPIO/UART-TXD	Pin 8, TXD/GPIO14	Connected to cellular module RXD	Input to shield.
D0: GPIO/UART-RXD	Pin 10, RXD/GPIO15	Connected to cellular module TXD	Output from shield.
A5: GPIO/AIN/I2C-SCL	Not used	Not used	
A4: GPIO/AIN/I2C-SDA	Not used	Not used	
A3: GPIO/AIN	Not connected	Not connected	
A2: GPIO/AIN	Not connected	Not connected	
A1: GPIO/AIN	Not connected	Not connected	
A0: GPIO/AIN	Not connected	Not connected	
IOREF	Not connected	Not connected	
RESET	Pin 7, normally not connected	Normally not connected	Can control reset of the positioning module if configuration resistor

			R91 is mounted. Can control reset of the cellular module if configuration resistor R90 is mounted.
VIN	Does not exist	Can power the shield if highest voltage is present on this net.	Note: 5-14V DC, 1Amp
5V		Can power the shield if highest voltage is present on this net.	
3.3V	Not connected	Not connected	

5.6 Raspberry Pi Connector

The Raspberry Pi (RPi) connector pads are compatible with the 2x13 pos expansion connector found on the RPi. The shield and RPi can easily be connected with the help of a 26-pos flat cable. Note that pin headers must be soldered.

The RPi connections are placed in parallel over the Arduino connectors and are numbered according to the Arduino pins. See table under Arduino pinning for details.

An external power supply is needed in most cases since the RPi cannot deliver enough current for the cellular modem.

5.7 USB Connector

This is a micro-AB connector. When SARA-G350 is mounted this connector can only be used for powering the shield. When SARA-U270 is mounted it is an optional USB interface that can connect to a PC or an embedded system with a USB Host interface (and appropriate software driver). In the latter case, the USB connector can also be used to just power the shield.

5.8 LED

There are three LEDs:

- Yellow - signals presence of 3.3V, i.e. the shield is powered.
- Green - the once per second pulse from the GPS/GNSS module.
- Red - is a configurable indicator connected to GPIO1 on the cellular module.

5.9 Locating Components

There are nine configuration resistors on the board. The picture below shows their location. Normally there is no need to change the default setting but for prototyping situations, some of them can be mounted.

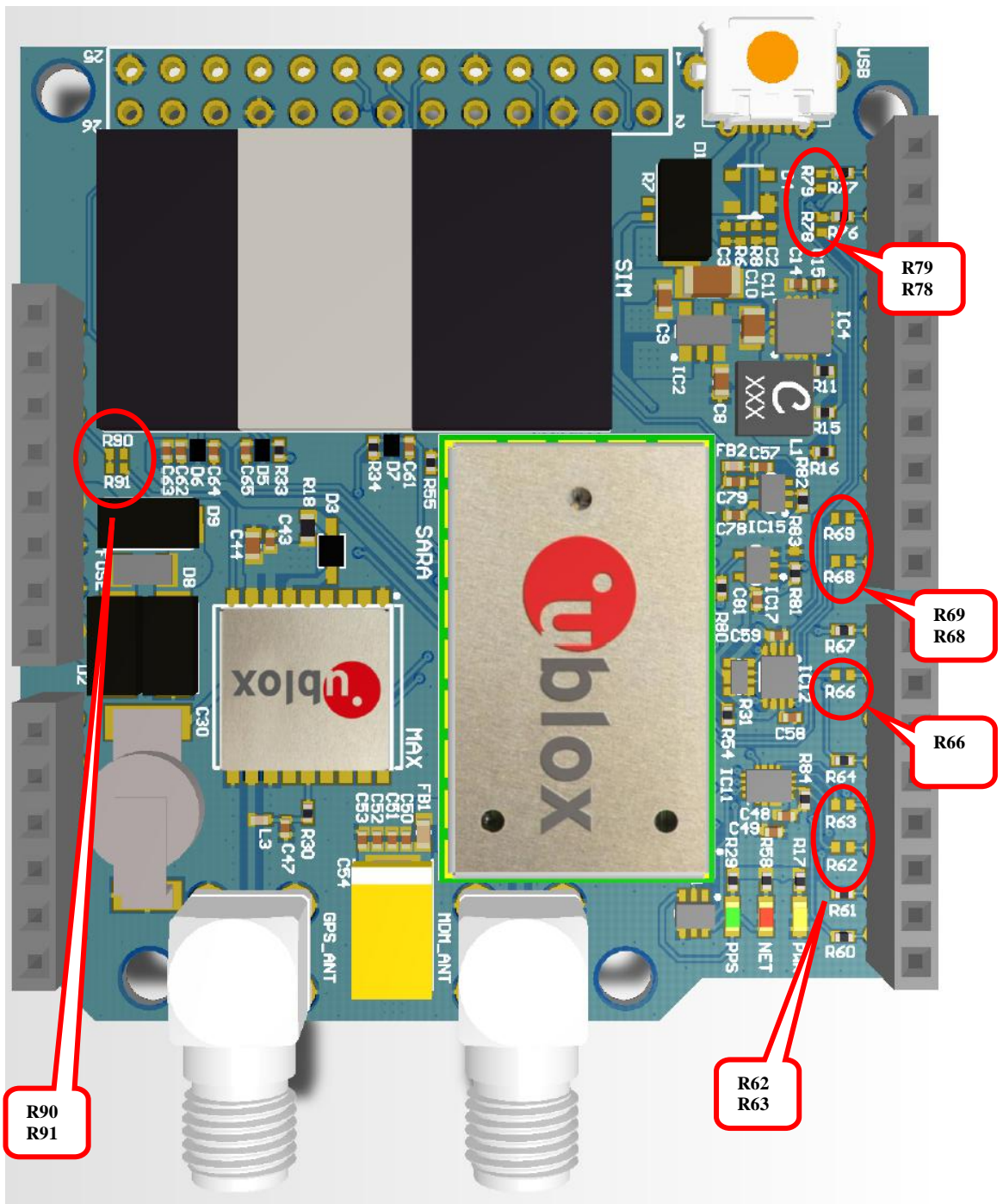

Figure 8 – Configuration Resistor Locations

6 Things to Note

This chapter contains information that can be relevant to check in case some problems or issues appear when using the shield.

6.1 SIM Card not Found

If the cellular modem gives a message that the SIM cards cannot be found it is likely that a **power cycle is needed** - not just removing and inserting the SIM card again. Remember that **all** supply voltages to the shield must be removed during the power cycle.

In the system integration manuals for the cellular modems it is clearly stated in section 2.5 that the modules do not support SIM hot insertion / removal.

7 Further Information

The LPC4088 microcontroller is a complex circuit and there exist a number of other documents with a lot more information. The following documents are recommended as a complement to this document.

- [1] u-blox SARA-U270 UMTS/HSPA/GSM modem information
<http://www.u-blox.com/en/wireless-modules/umtshsdpa-modules/sara-u2-series.html>
- [2] u-blox SARA-G350 GSM/GPRS modem information
<http://www.u-blox.com/en/wireless-modules/gsm-gprs-modules/sara-gsm-module-family.html>
- [3] u-blox MAX-7M GPS/GNSS module
<http://www.u-blox.com/en/gps-modules/pvt-modules/max-7.html>
- [4] u-blox MAX-M8 GPS/GNSS module
<http://www.u-blox.com/en/gps-modules/pvt-modules/max-m8-series-concurrent-gnss-modules.html>
- [5] LPCware, NXP's community for developers
<http://www.lpcware.com/>
- [6] LPCXpresso IDE: NXP's low-cost development platform for LPC families, which is an Eclipse-based IDE.
<http://www.lpcware.com/lpcxpresso>
- [7] LPCOpen - a Software Development Platform for NXP's LPC Microcontrollers
<http://www.lpcware.com/lpcopen>
- [8] mbed.org, the official site for mbed development and gives access to all documentation and the on-line compiler.
<http://mbed.org>

Note that there can be newer versions of the documents/links than the ones listed above. Always check for the latest information/version.