

Product Overview

The A011 FlexBlockTM High Output Wide Range LED Power Modules are a line of true current regulated drivers for powering LEDs. The LUXdrive FlexBlockTM line of LED drivers are the ideal choice for powering all types of high-brightness and high-power LED packages and arrays.

FlexBlockTM LED drivers provide high efficiency and require no external current limiting resistors. A fast response current-sensing circuit makes the FlexBlockTM ideal for applications where flashing or strobe operation of the LED(s) is required. As a Buck-Boost driver, the FlexBlockTM can handle LED loads that are above, below, or the same voltage as the power supply.

A dimming input, compatible with many commercially available 0-10V low voltage dimming controls, provides a convenient method to control the brightness of the LEDs. The standard units are potted in an extremely small, low profile package¹ and come with 6" 18AWG colored leads.



Features

- DC input voltage up to 32V
- 350mA or 700mA constant current output¹
- Extremely small form factor¹ (2.0"x1.2"x0.38")
- 18 AWG wires for easy electrical connections
- External analog/digital intensity control
- External potentiometer intensity control (0%, 5-100%)
- Continuous output short circuit protection²
- Continuous output open circuit protection
- Input reverse polarity protection with PolarifetTM Technology
- Pulse and strobe capable (dim input)
- 0-10V Dimming compatible with many available controls

Typical Applications

- Solar & Landscape Lighting
- Architectural Lighting
- Track Lighting
- Automotive & Marine Lighting
- Portable Lighting & Flashlights
- Point of Purchase Lighting
- Desk & Reading Lamps
- Signal & marker Lighting
- Flashing & Strobe Lighting
- Cabinet & Display Case Lighting
- Sign & Channel Letters
- Much More...

MADE IN



U. S. A.

¹ - Custom units can be designed for OEM applications. Contact LUXdrive for more information.
² - When wired in the default Buck-Boost configuration.



Part Number Identification Table

Table 1
Product Selection

Part Number	DC Input	Drive Current (mA)	Control/Dimming	Connection Type
A011-D-V-350	10-32V	350	0-10V	6 Wires
A011-D-V-700	10-32V	700	0-10V	6 Wires

Notes for Table 1:
Custom units available upon request, restrictions apply. Contact LUXdrive for additional details.

Part Number Identification

The part number is explained below:

A011- A- B -CCC

Where:

- A011 designates the LUXdrive Product ID for a FlexBlock
- A designates Power Input Type (D for DC only)
- B designates Dimming Type (V = 0-10V Dimming)
- CCC designates Drive Current (350 = 350mA, 700 = 700mA)

Absolute Maximum Ratings

Input Voltage	32V _{DC}
Output Voltage	48V _{DC} ³
DIM Input	10V

Typical Characteristics

Output tolerance (within specified temp. range)	±10%
Efficiency	90%
Input Voltage Minimum	10V _{DC}
Max Output Voltage in Buck-Boost Mode (Default)	48V _{DC} - V _{in}
Max Output Voltage in Boost Only Mode	48V _{DC}

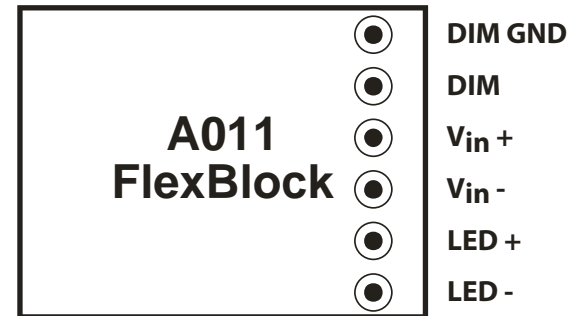

Figure 1.
Top view Pinout of the
A011 FlexBlock

3 - When wired in the Boost Mode.

Graphs

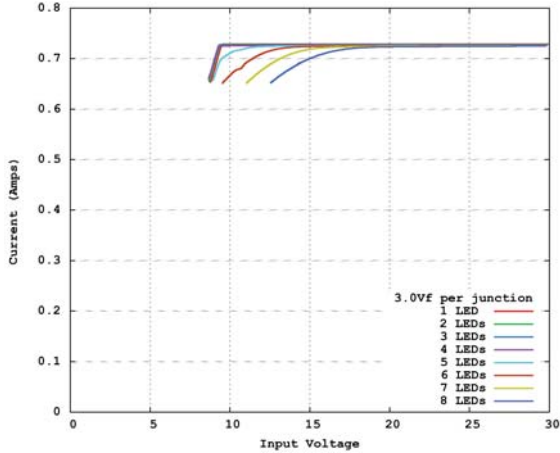

Figure 2.
700mA Buck-Boost Mode Output Current vs. Vin

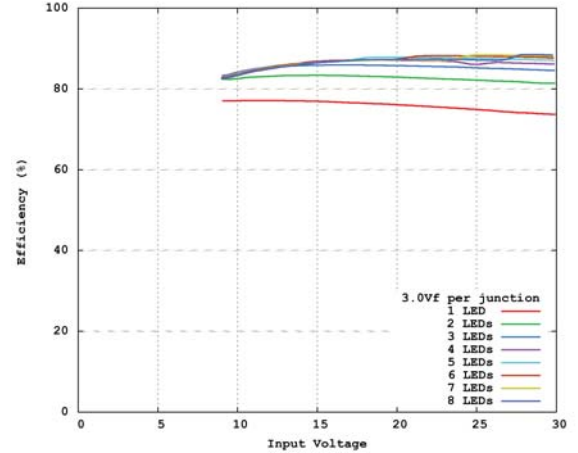

Figure 3.
700mA Buck-Boost Mode Efficiency vs. Vin

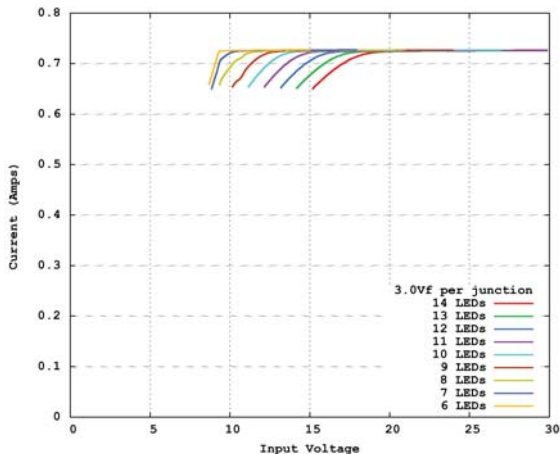

Figure 4.
700mA Boost Only Mode Output Current vs. Vin

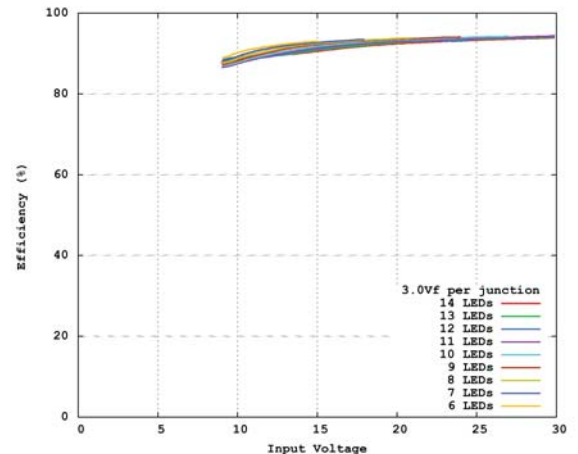

Figure 5.
700mA Boost Only Mode Efficiency vs. Vin

Specifications

Output current, A011-D-V-350	350mA
Output current, A011-D-V-700	700mA
Dimming Input, turn on threshold	1.7V ±5%
Dimming Input, full on threshold	9V ±5%
External pot adjustment range	0%, 5-100% ⁴
Output rise time	<2 ms ^{5,6}
Output fall time	<100 μs ^{5,6}
Quiescent current (DIM = 0V)	<6 mA ⁶
Operating temperature (Tcase)	-40+80°C
Storage temperature	-40+125°C

Application Information

The FlexBlockTM High Output LED Power Module is a high-efficiency dc to dc converter that delivers a fixed output current by varying the output voltage as required to maintain the specified current. Because the forward voltage of LEDs can change based on several environmental factors as well as the age of the LED, it is important to use this type of driver in an LED system. A fast response current-sensing circuit permits the unit to be used in applications where flashing or pulsing of the LEDs is required. Several options are available allowing for use with many types of LEDs and in a variety of operating modes.

Fixed Current Drive

When the dimming wires (purple/gray) are left unconnected, the FlexBlock is designed to supply its rated current to one or more LED junctions. For example, a 700mA rated unit will drive up to five white 700mA LEDs connected in series at 12V_{DC}. See figure 2 and figure 3.

When wired in the default configuration, as marked on the top of the unit, the A011 FlexBlock is in Buck-Boost mode. This is the most flexible mode as it allows the input voltage to be below, the same, or above the output voltage. This mode is recommended for loads with up to 6 LEDs in series.

A second, more efficient wiring option puts the A011 FlexBlock in boost-only mode. In this mode, the LED+ output is not used, and the positive end of the LED load is instead connected to Vin+. This is shown in Figure 11. It is extremely important that Vin < Vout under all conditions (LED forward voltages shrink slightly as the LEDs warm up and as the LEDs are dimmed). If white LEDs are going to be dimmed, it is recommended that Vin be less than (2V * #LEDs in series) to make sure the LEDs can be fully extinguished. This is due to the fact that many LEDs will begin to light up at around 2.5V, at a reduced current, even when rated at 3.0Vf.

Figure 10 shows a 700mA unit driving multiple LEDs. Note that parallel strings of LEDs can be driven directly with no additional circuitry required to insure current sharing. The nature of the LEDs themselves will provide sufficient current sharing if the parallel strings comprise three or more junctions each, and are identical in length.

4 - Refer to figure 9 for the dimming response.

5 - Tested at 24V_{in}, 24V_{out}

6 - Actual value varies greatly based on input and/or output voltages. Actual values will be smaller in most applications.

Adjustable Current - External Control - "V" Model

Figures 14 and 15 show the ease of dimming the A011 FlexBlockTM High Output LED Power Module. Figure 14 shows the simplest dimming configuration using a 20K Ohm potentiometer. This gives a 0%, 5-100% range of dimming. See figure 9. If multiple A011 modules are to be dimmed with a single potentiometer, the value of the potentiometer should be approximately (20KΩ/N) where N is the number of modules.

Figure 15 shows a 0-10V wall dimmer, such as the LEDdynamics A019 Low Voltage Dimming Control, being used to control the LED brightness. This is the preferred choice for dimming multiple units, as the 0-10V dimming control can handle several drivers. The 0-10V input can also be supplied by a commercial lighting controller that has **current-sinking** 0-10V outputs, allowing the integration of LEDs with other forms of lighting in large automated systems.

For large systems where several distant FlexBlock modules will be dimmed together, it is important to use a heavier gauge wire (such as 18AWG) to run the DIM lines in a star wiring pattern (where each module has a run all the way back to the 0-10V dimming control). This will help to negate any voltage drops along the DIM wires that could cause some lamps to dim differently than others.

For more advanced control, the 0-10V input can be Pulse Width Modulated (PWM). Figure 18 shows how interfacing with a microcontroller can easily be accomplished with a 2N3904 or equivalent transistor. A PWM frequency of 200Hz is recommended. This configuration can also be used to strobe or pulse the LEDs with a TTL or CMOS logic signal.

In addition to the configurations described above, the FlexBlock may also be driven by a D to A converter. The D/A converter must be able to sink at least 1mA of current from the 0-10V input of the FlexBlock. If the D/A converter cannot sink current, a voltage follower with an open collector output should be used between the D/A converter and the 0-10V input.

If the dimming control circuit used with the FlexBlock has the potential to exceed 10V, current into the DIM input needs to be limited to 10mA or less. See figure 8.

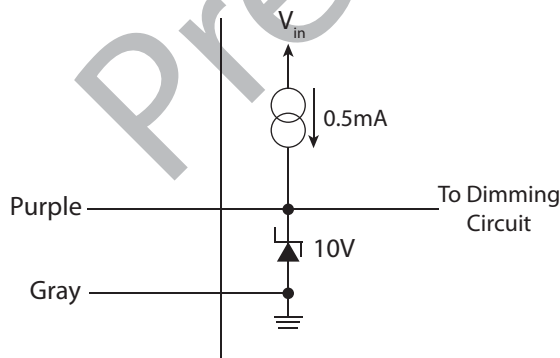

Figure 8.
Dimming input equivalent circuit

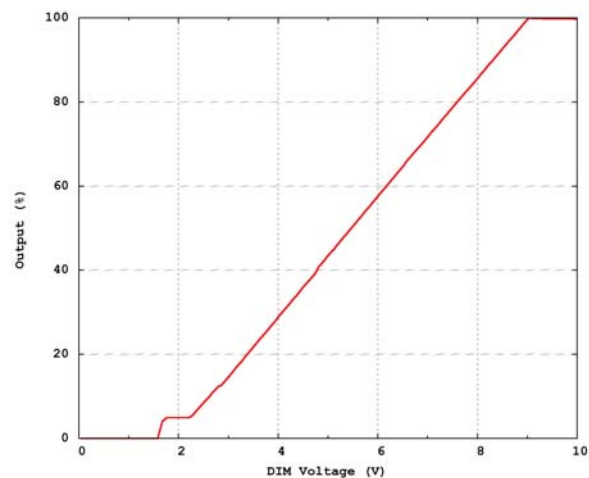

Figure 9.
Output vs. Dim Voltage

External On/Off Control

Where a manual on/off control is desired, the potentiometer in Figure 14 may be replaced by a pushbutton or toggle switch. The output current will be zero and the input current will drop to the quiescent level when the switch is closed. Figures 16 and 17 show external dimming control combined with on/off control.

Thermal Management

The FlexBlock can run many LED load configurations with no additional heat sinking in an ambient of 25°C. In situations with elevated ambient temperatures, such as those that might be experienced inside an enclosed fixture, additional heat sinking may be required. If the temperature of the driver (as measured at the T marking on the label) exceeds 60°C, additional heat sinking is recommended. If the temperature of the driver exceeds 80°C, additional heat sinking is required.

The best surface for removing heat from the FlexBlock is the back side (opposite the labeled side). The module can be attached to a heat sink with thermal grease and a mounting bracket that presses the unit firmly against the heat sink, or with double-sided tape that provides both the thermal path and mechanical mounting. When using tape (such as 3M F9469PC, a Very High Bond (VHB) tape suitable for permanent mounting), using a thinner variety (0.005" thick or less) will aid in getting the heat through the tape and to the heat sink. Care should be taken when positioning the FlexBlock module with VHB tape as the high bond strength makes removing or repositioning the module very difficult.

If the FlexBlock becomes too hot during use, it will reduce the output current to limit the power dissipation. If the temperature continues to rise, the driver will turn off until the temperature drops to a safe level.

Connections

In all cases, the LEDs being driven should be located as close to the FlexBlock LED output as possible. 18AWG wire should be adequate for most wiring, but a heavier gauge should be considered when long leads are required.

The power input wires should also be kept short. Where the power source is located several feet from the unit, a 100µF or larger, 50V capacitor may be required across the input terminals as shown in Figure 20.

Application Figures

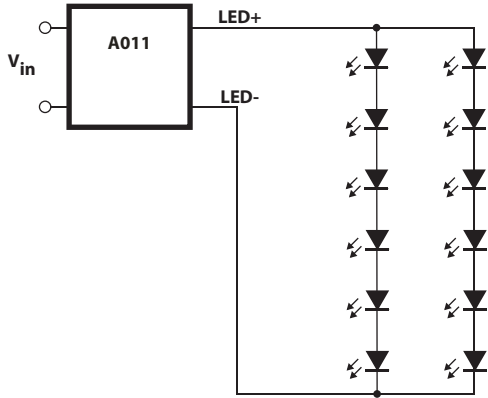

Figure 10.
700mA unit driving 12 High Power LEDs
(VIN ≥ 15VDC)

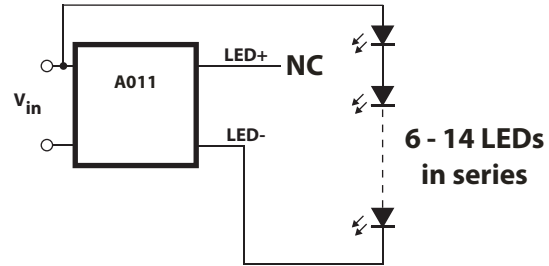

Figure 11.
Boost Only Mode
(VIN MUST be less than VOUT)

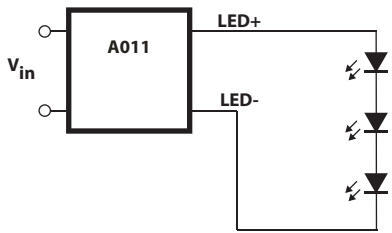

Figure 12.
700mA unit driving three High Power LEDs at 2W each

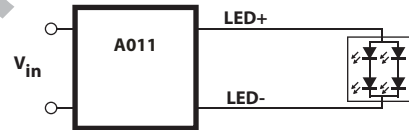

Figure 13.
700mA unit driving one Cree XMLEZW emitter

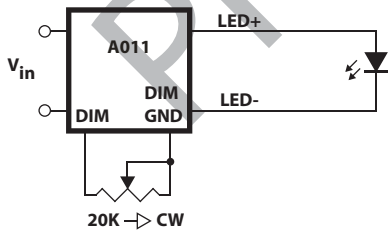

Figure 14.
External potentiometer

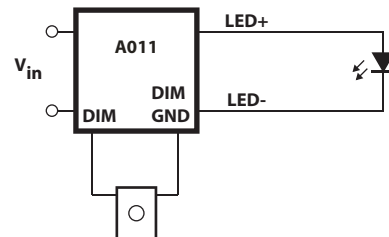

Figure 15.
External 0-10V dimming controller

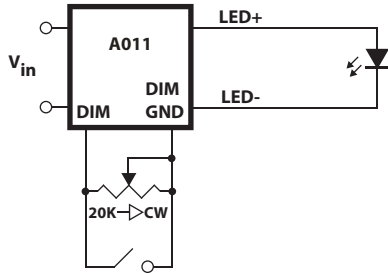

Figure 16.
External dimming plus ON/OFF control with switch closure

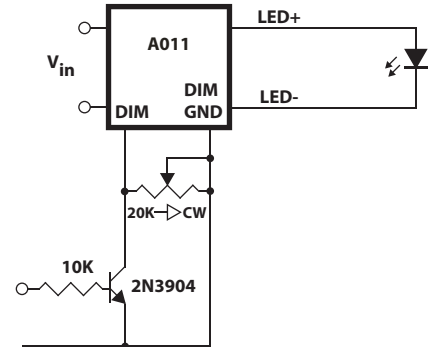

Figure 17.
External dimming plus ON/OFF control with logic level input

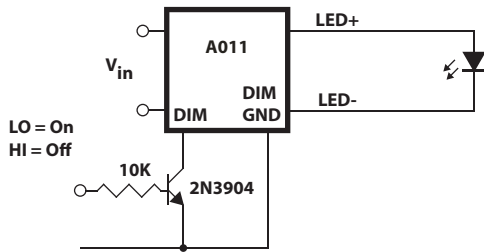

Figure 18.
Pulse/Strobe input 5V=OFF

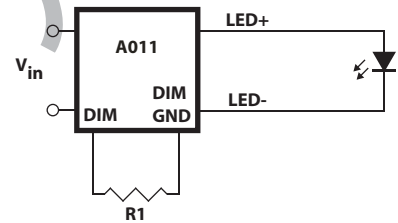

Figure 19.
Using resistor for fixed current reduction
Output is approximately: $\%I_{OUT} = R1/200$
EG: 10K \approx 50%

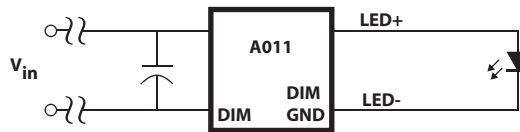
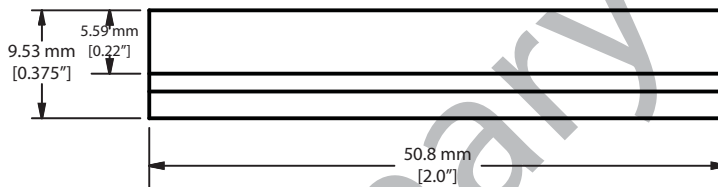
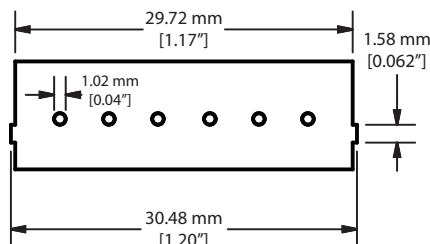

Figure 20.
Place a capacitor across the input terminals when the distance to the DC power source is farther than several feet

Physical Dimensions



A009
6" - 18AWG Colored Leads

